



1996

OWNERS MANUAL





The 1996 Corvette Owner's Manual

| | |
|--|-----|
| Seats and Restraint Systems | 1-1 |
| This section tells you how to use your seats and safety belts properly. It also explains the air bag system. | |
| Features and Controls | 2-1 |
| This section explains how to start and operate your Corvette. | |
| Comfort Controls and Audio Systems | 3-1 |
| This section tells you how to adjust the ventilation and comfort controls and how to operate your audio system. | |
| Your Driving and the Road | 4-1 |
| Here you'll find helpful information and tips about the road and how to drive under different conditions. | |
| Problems on the Road | 5-1 |
| This section tells you what to do if you have a problem while driving, such as a flat tire or overheated engine, etc. | |
| Service and Appearance Care | 6-1 |
| Here the manual tells you how to keep your Corvette running properly and looking good. | |
| Maintenance Schedule | 7-1 |
| This section tells you when to perform vehicle maintenance and what fluids and lubricants to use. | |
| Customer Assistance Information | 8-1 |
| This section tells you how to contact Chevrolet for assistance and how to get service and owner publications. It also gives you information on "Reporting Safety Defects" on page 8-9. | |
| Index | 9-1 |
| Here's an alphabetical listing of almost every subject in this manual. You can use it to quickly find something you want to read. | |



GENERAL MOTORS, GM and the GM Emblem, CHEVROLET, the CHEVROLET Emblem, CORVETTE and the CORVETTE Emblem, are registered trademarks of General Motors Corporation.

This manual includes the latest information at the time it was printed. We reserve the right to make changes in the product after that time without further notice. For vehicles first sold in Canada, substitute the name "General Motors of Canada Limited" for Chevrolet Motor Division whenever it appears in this manual.

Please keep this manual in your Corvette, so it will be there if you ever need it when you're on the road. If you sell the vehicle, please leave this manual in it so the new owner can use it.

Litho in U.S.A.
Part No. 10261162 B • First Edition



We support voluntary technician certification.

For Canadian Owners Who Prefer a French Language Manual:

Aux propriétaires canadiens: Vous pouvez vous procurer un exemplaire de ce guide en français chez votre concessionnaire ou au:

DGN Marketing Services Ltd.
1500 Bonhill Rd.
Mississauga, Ontario L5T 1C7

© Copyright General Motors Corporation 1995
All Rights Reserved



CORVETTE: THE AMERICAN DREAM MACHINE

In the early '50s, it was only a designer's dream. Today the Corvette stands alone as America's dream car -- a testament to its unmistakable charisma and the excitement it inspires. Unique styling, powerful performance and an undeniable panache have made Corvette one of the most celebrated sports cars in the world.

In 1953, Corvette produced 300 new lightweight fiberglass roadsters. A handful went to project engineers, General Motors managers, and a select group of movie stars and celebrities. With a two-speed Powerglide automatic transmission, Blue Flame six-cylinder engine, and gleaming Polo White exterior, the Corvette began its drive into the heart of America.

Designers freshened up the 'Vette in 1956 by adding a removable hardtop and the famous Corvette "coves." The sculptured body enhanced its sporty look, and a standard 210-horsepower Chevy V8 engine solidified Corvette's reputation as a production race car.



In 1963, Corvette hit the road with an eye-catching new look -- the Sting Ray coupe. An instant success, the now-classic Sting Ray featured concealed headlamps and a unique split rear window. The split window would only be offered in 1963, making this model among the most prized Corvettes ever built.

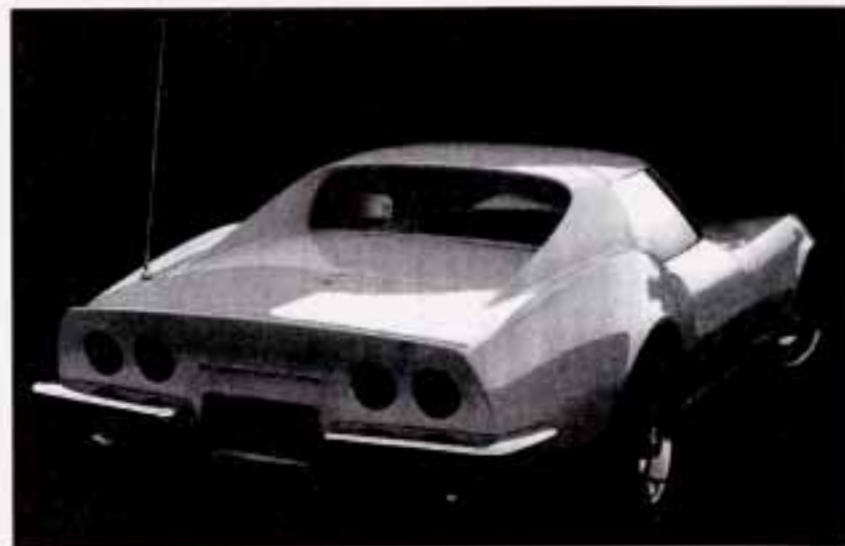

Restyled inside and out for 1968, this 'Vette sported a lean and hungry shape, creating a sense of motion even when standing still. And for the first time, Corvette offered removable roof panels.



For its 25th anniversary, the 1978 Corvette received a new fastback roofline with a wide expanse of glass that wrapped around the sides. Emblems front and rear identified the '78 'Vette as a Silver Anniversary model.



Now in its 44th year of production, Corvette only gets better. From the Grand Sport 330-horsepower LT4 engine to state-of-the-art refinements standard on all Corvettes, today's Corvette is a premier driving machine.

In 1984, the fourth generation of America's favorite sports car anticipated the future with a sleek look and advanced technology that provided superior handling and performance. Windshield angle was the sheerest of any domestic vehicle, cornering ability the tightest of any production car. In short, the 1984 redesign enhanced the Corvette's reputation as a leader in the world sports car market.



CORVETTE ASSEMBLY PLANT

The Corvette Assembly Plant in Bowling Green, Kentucky is one of the most sophisticated and computerized automobile assembly facilities in the world. To build your 1996 Corvette, over 1,200 employees teamed up with the 70 high-tech robots that assist in a variety of processes, from welding to painting.

The Bowling Green facility is Corvette's third home since 1953. Since beginning production in June of 1981, it has become one of Kentucky's most popular tourist attractions.

Corvette Assembly Plant tours are conducted Monday through Friday. Reservations are required for groups of 10 or more. For more information, call (502) 745-8228.

The new National Corvette Museum, located near the assembly plant, opened its doors in September of 1994. It is also attracting tourists to the area.

How to Use This Manual

Many people read their owner's manual from beginning to end when they first receive their new vehicle. If you do this, it will help you learn about the features and controls for your vehicle. In this manual, you'll find that pictures and words work together to explain things quickly.

Index

A good place to look for what you need is the Index in the back of the manual. It's an alphabetical list of all that's in the manual, and the page number where you'll find it.

Safety Warnings and Symbols

You will find a number of safety cautions in this book. We use a box and the word CAUTION to tell you about things that could hurt you if you were to ignore the warning.



CAUTION:

These mean there is something that could hurt you or other people.

In the caution area, we tell you what the hazard is. Then we tell you what to do to help avoid or reduce the hazard. Please read these cautions. If you don't, you or others could be hurt.



You will also find a circle with a slash through it in this book. This safety symbol means "Don't," "Don't do this," or "Don't let this happen."

Vehicle Damage Warnings

Also, in this book you will find these notices:

NOTICE:

These mean there is something that could damage your vehicle.

In the notice area, we tell you about something that can damage your vehicle. Many times, this damage would not be covered by your warranty, and it could be costly. But the notice will tell you what to do to help avoid the damage.

When you read other manuals, you might see CAUTION and NOTICE warnings in different colors or in different words.

You'll also see warning labels on your vehicle. They use the same words, CAUTION or NOTICE.

Vehicle Symbols

These are some of the symbols you may find on your vehicle.

For example, these symbols are used on an original battery:

CAUTION
POSSIBLE
INJURY



PROTECT
EYES BY
SHIELDING



CAUSTIC
BATTERY
ACID COULD
CAUSE
BURNS



AVOID
SPARKS OR
FLAMES



SPARK OR
FLAME
COULD
EXPLODE
BATTERY



These symbols are important for you and your passengers whenever your vehicle is driven:

DOOR LOCK
UNLOCK



FASTEN
SEAT
BELTS



POWER
WINDOW



AIR BAG



These symbols have to do with your lights:

MASTER
LIGHTING
SWITCH



TURN
SIGNALS



PARKING
LAMPS



HAZARD
WARNING
FLASHER



DAYTIME
RUNNING
LAMPS



FOG LAMPS



These symbols are on some of your controls:

WINDSHIELD
WIPER



WINDSHIELD
WASHER



WINDSHIELD
DEFROSTER



REAR
WINDOW
DEFOGGER



VENTILATING
FAN



These symbols are used on warning and indicator lights:

ENGINE
COOLANT
TEMP



BATTERY
CHARGING
SYSTEM



BRAKE



COOLANT



ENGINE OIL
PRESSURE



ANTI-LOCK
BRAKES



Here are some other symbols you may see:

FUSE



LIGHTER



HORN



SPEAKER



FUEL





Section 1 Seats and Restraint Systems

Here you'll find information about the seats in your Corvette and how to use your safety belts properly. You can also learn about some things you should *not* do with air bags and safety belts.

Seats and Seat Controls

This part tells you about the seats -- how to adjust them, and also about reclining seatbacks and seatback latches.

Manual Seat

CAUTION:

You can lose control of the vehicle if you try to adjust a manual driver's seat while the vehicle is moving. The sudden movement could startle and confuse you, or make you push a pedal when you don't want to. Adjust the driver's seat only when the vehicle is not moving.

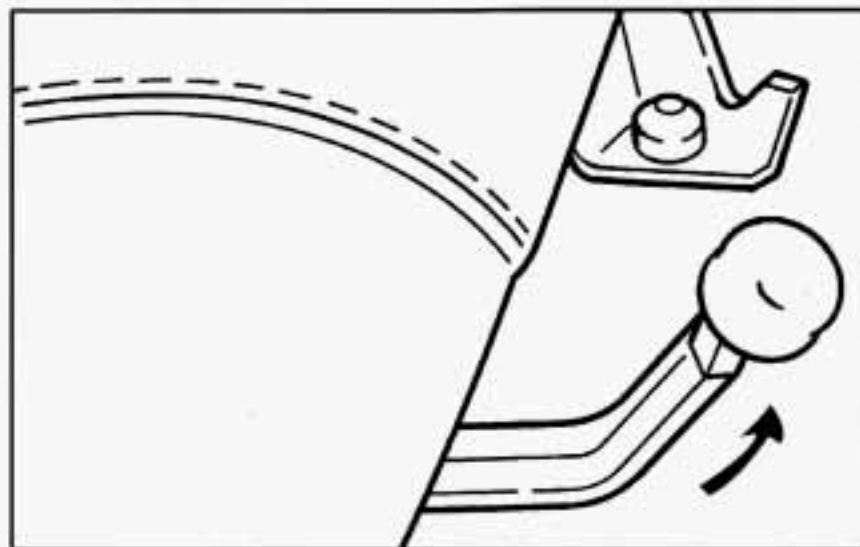

Move the lever under the front of the seat to unlock it. Slide the seat to where you want it. Then release the lever and try to move the seat with your body, to make sure the seat is locked into place.

Power Seat (Option)

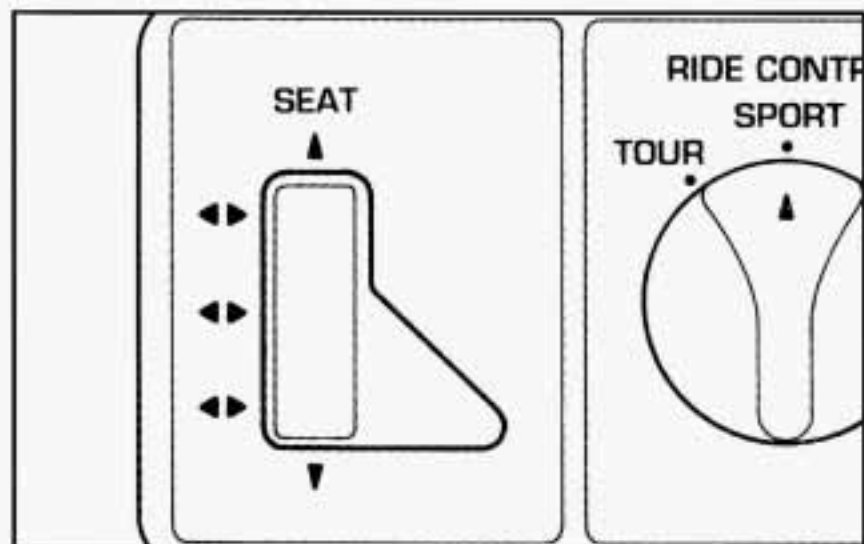

If you have the Sport Seat, you must move the switch next to the lumbar controls to DR (driver) or PS (passenger) before adjusting your power seat.

Different parts of the power seat control move different parts of your seat. If you move the whole control, the whole seat will move. The back of the control will move the back of the seat, and the front of the control will move the front of the seat.

Move the control to the front or to the back to move the seat forward or backward. Move the control toward the center of the vehicle to raise the seat and away from the center of the vehicle to lower it.

Sport Seat (Option)

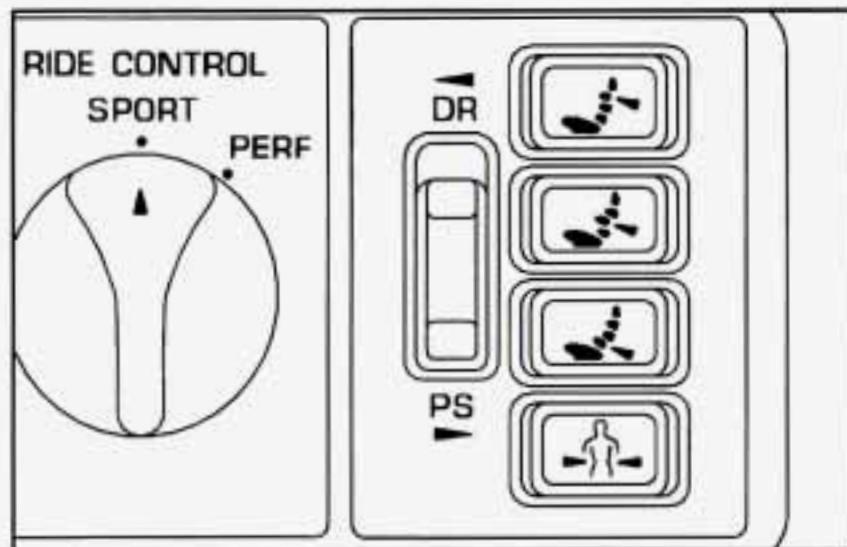

These switches let you change the shape of your seat. There are three lumbar supports for the upper, middle and lower back. There's also a side bolster that adjusts the sides of the seat around you to give you more lateral support.

First move the selector switch to DR (driver) or PS (passenger). Then move the shaping switches until your seat is comfortable. For lumbar support, move each switch left to inflate or right to deflate.

Reclining Seatbacks



To adjust the seatback, push the lever back and move the seatback to where you want it. Release the lever to lock the seatback in place.



But don't have a seatback reclined if your vehicle is moving.

⚠ CAUTION:

Sitting in a reclined position when your vehicle is in motion can be dangerous. Even if you buckle up, your safety belts can't do their job when you're reclined like this.

The shoulder belt can't do its job because it won't be against your body. Instead, it will be in front of you. In a crash you could go into it, receiving neck or other injuries.

The lap belt can't do its job either. In a crash the belt could go up over your abdomen. The belt forces would be there, not at your pelvic bones. This could cause serious internal injuries.

For proper protection when the vehicle is in motion, have the seatback upright. Then sit well back in the seat and wear your safety belt properly.

Seatback Latches



Both seatbacks fold forward to give you access to the rear area. To fold a seatback forward, lift this latch and push the seatback forward. When you return the seatback to its original position, make sure the seatback is locked.



CAUTION:

If the seatback isn't locked, it could move forward in a sudden stop or crash. That could cause injury to the person sitting there. Always press rearward on the seatback to be sure it is locked.

Safety Belts: They're for Everyone

This part of the manual tells you how to use safety belts properly. It also tells you some things you should not do with safety belts.

And it explains the air bag system.

CAUTION:

Don't let anyone ride where he or she can't wear a safety belt properly. If you are in a crash and you're not wearing a safety belt, your injuries can be much worse. You can hit things inside the vehicle or be ejected from it. You can be seriously injured or killed. In the same crash, you might not be if you are buckled up. Always fasten your safety belt, and check that your passenger's belt is fastened properly too.



Your vehicle has a light that comes on as a reminder to buckle up. (See "Safety Belt Reminder Light" in the Index.)

In most states and Canadian provinces, the law says to wear safety belts. Here's why: *They work.*

You never know if you'll be in a crash. If you do have a crash, you don't know if it will be a bad one.

A few crashes are mild, and some crashes can be so serious that even buckled up a person wouldn't survive. But most crashes are in between. In many of them, people who buckle up can survive and sometimes walk away. Without belts they could have been badly hurt or killed.

After more than 25 years of safety belts in vehicles, the facts are clear. In most crashes buckling up does matter ... a lot!

Why Safety Belts Work

When you ride in or on anything, you go as fast as it goes.

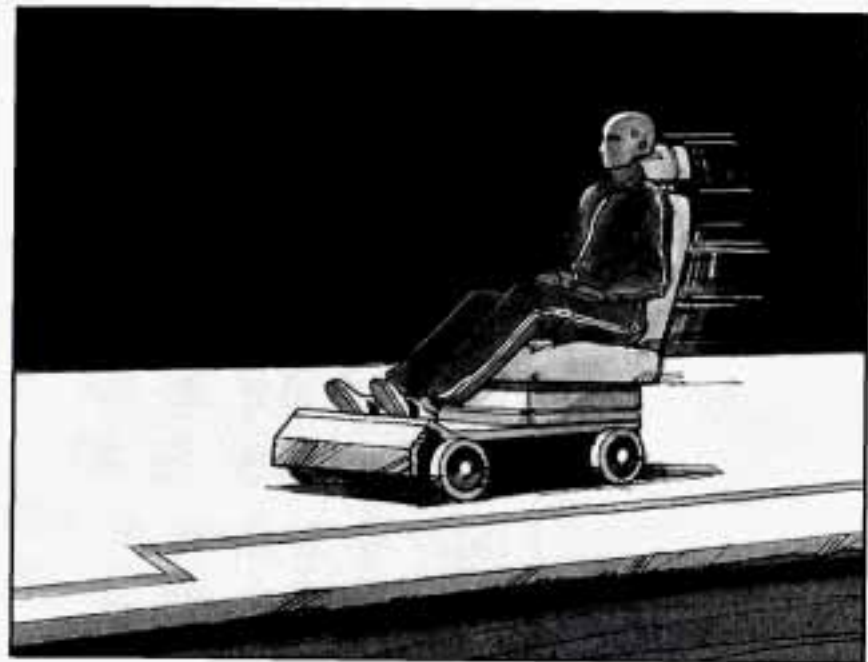
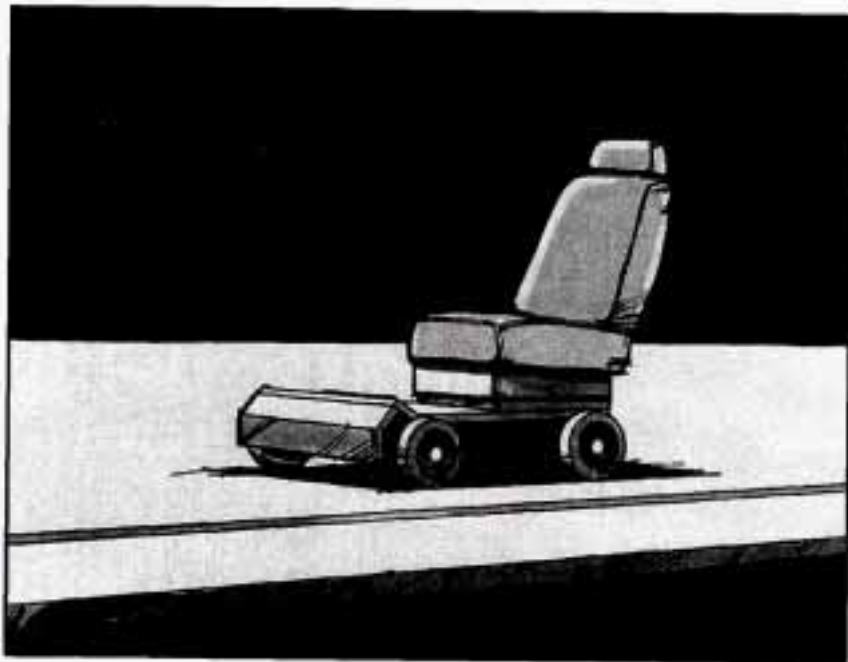

Put someone on it.

Take the simplest vehicle. Suppose it's just a seat on wheels.

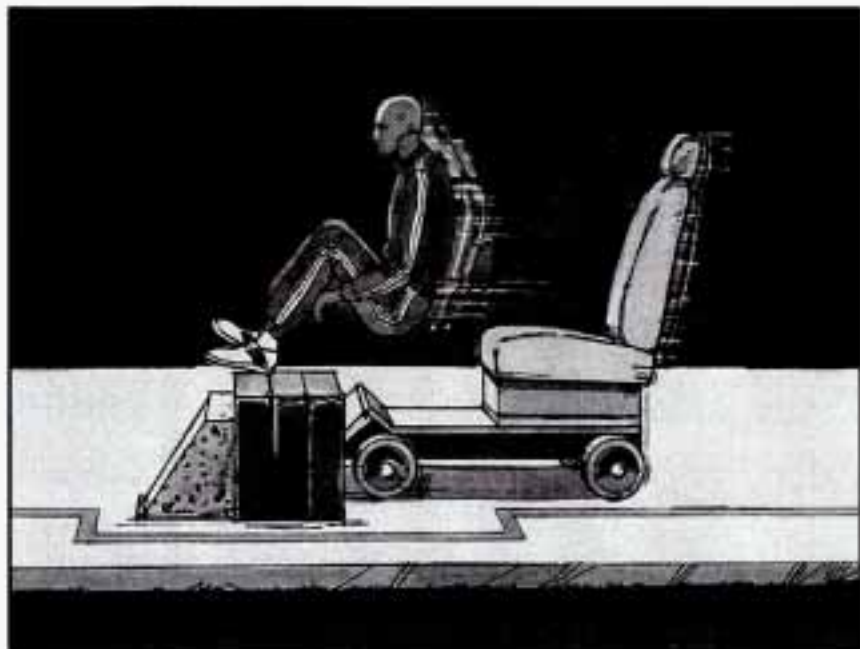

Get it up to speed. Then stop the vehicle. The rider doesn't stop.



The person keeps going until stopped by something. In a real vehicle, it could be the windshield ...

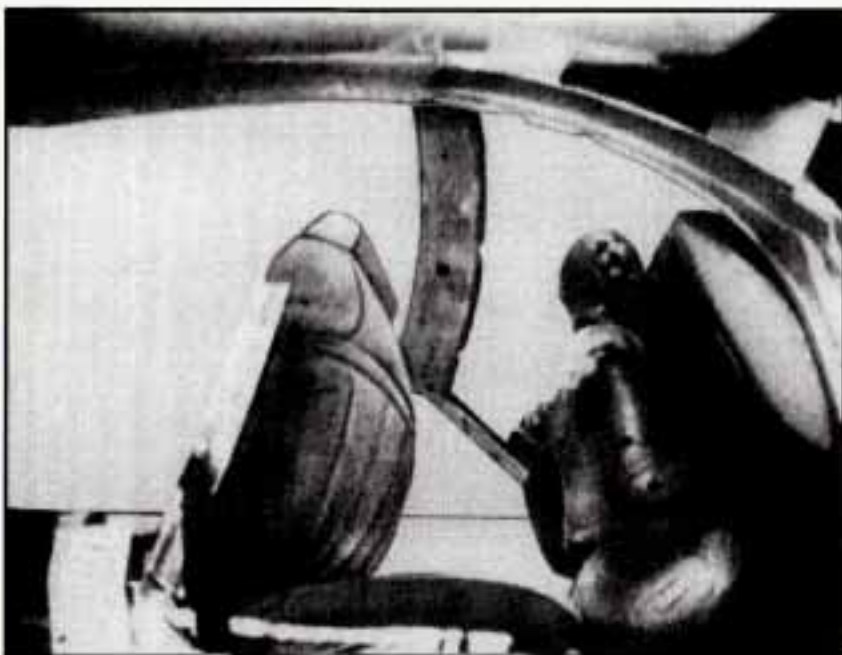

or the instrument panel ...



or the safety belts!

With safety belts, you slow down as the vehicle does. You get more time to stop. You stop over more distance, and your strongest bones take the forces. That's why safety belts make such good sense.

Here Are Questions Many People Ask About Safety Belts -- and the Answers

Q: Won't I be trapped in the vehicle after an accident if I'm wearing a safety belt?

A: You *could* be -- whether you're wearing a safety belt or not. But you can unbuckle a safety belt, even if you're upside down. And your chance of being conscious during and after an accident, so you *can* unbuckle and get out, is *much* greater if you are belted.

Q: If my vehicle has air bags, why should I have to wear safety belts?

A: Air bags are in many vehicles today and will be in most of them in the future. But they are supplemental systems only; so they work *with* safety belts -- not instead of them. Every air bag system ever offered for sale has required the use of safety belts. Even if you're in a vehicle that has air bags, you still have to buckle up to get the most protection. That's true not only in frontal collisions, but especially in side and other collisions.

Q: If I'm a good driver, and I never drive far from home, why should I wear safety belts?

A: You may be an excellent driver, but if you're in an accident -- even one that isn't your fault -- you and your passenger can be hurt. Being a good driver doesn't protect you from things beyond your control, such as bad drivers.

Most accidents occur within 25 miles (40 km) of home. And the greatest number of serious injuries and deaths occur at speeds of less than 40 mph (65 km/h).

Safety belts are for everyone.

How to Wear Safety Belts Properly

Adults

This part is only for people of adult size.

Be aware that there are special things to know about safety belts and children. And there are different rules for smaller children and babies. If a child will be riding in your Corvette, see the part of this manual called “Children.” Follow those rules for everyone’s protection.

First, you’ll want to know which restraint systems your vehicle has.

We’ll start with the driver position.

Driver Position

This part describes the driver’s restraint system.

Lap-Shoulder Belt

The driver has a lap-shoulder belt. Here’s how to wear it properly.

1. Close and lock the door.
2. Adjust the seat (to see how, see “Seats” in the Index) so you can sit up straight.



3. Pick up the latch plate and pull the belt across you. Don't let it get twisted.
4. Push the latch plate into the buckle until it clicks.
Pull up on the latch plate to make sure it is secure. If the belt isn't long enough, see “Safety Belt Extender” at the end of this section.

Make sure the release button on the buckle is positioned so you would be able to unbuckle the safety belt quickly if you ever had to.

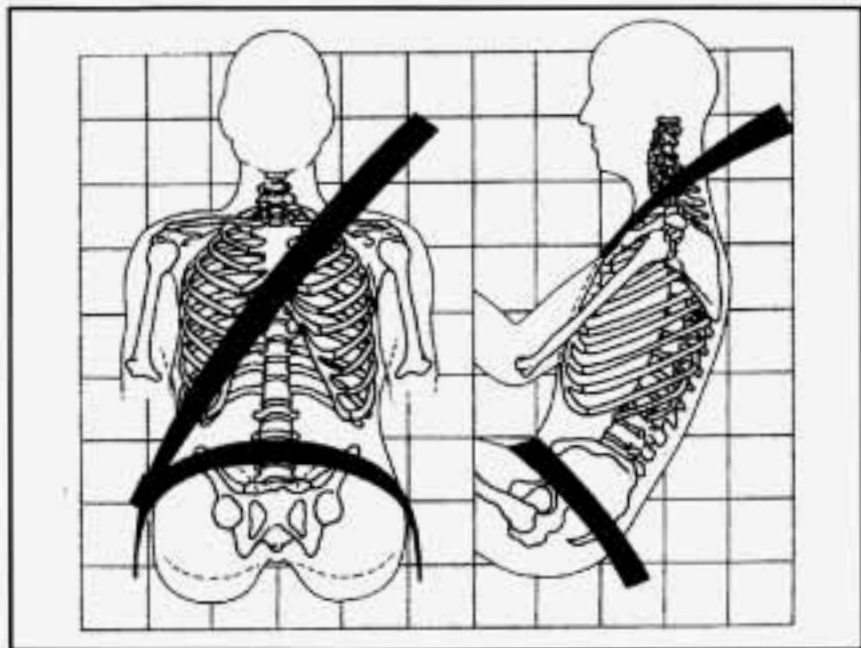

The lap part of the belt should be worn low and snug on the hips, just touching the thighs. In a crash, this applies force to the strong pelvic bones. And you'd be less likely to slide under the lap belt. If you slid under it, the belt would apply force at your abdomen. This could cause serious or even fatal injuries. The shoulder belt should go over the shoulder and across the chest. These parts of the body are best able to take belt restraining forces.

The safety belt locks if there's a sudden stop or crash.

Lap Belt Cinch Feature



If you do not want the lap belt to move freely, push the CINCH button. To loosen the belt, unbuckle it, let it retract, and buckle up again.

Q: What's wrong with this?

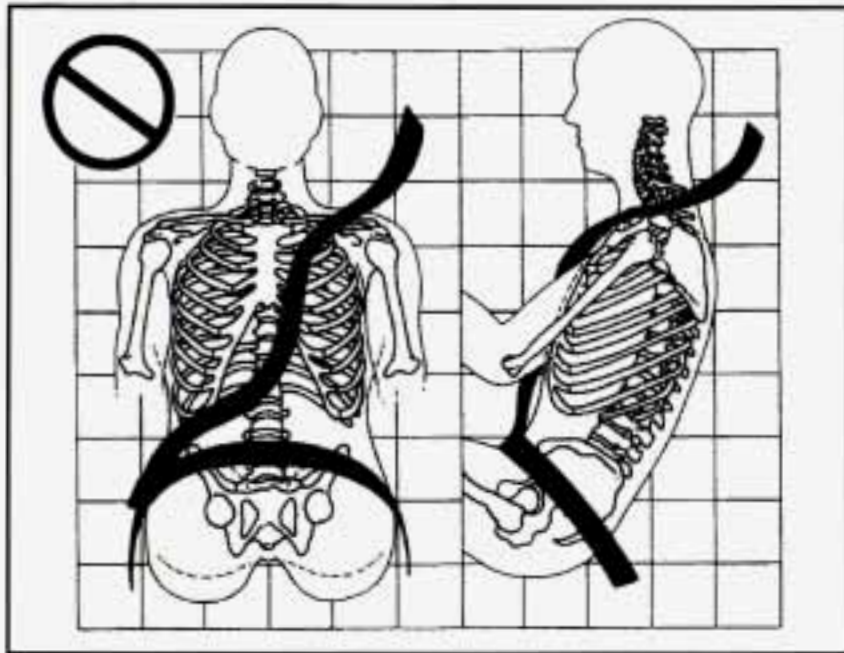

A: The shoulder belt is too loose. It won't give nearly as much protection this way.

⚠ CAUTION:

You can be seriously hurt if your shoulder belt is too loose. In a crash, you would move forward too much, which could increase injury. The shoulder belt should fit against your body.

Q: What's wrong with this?

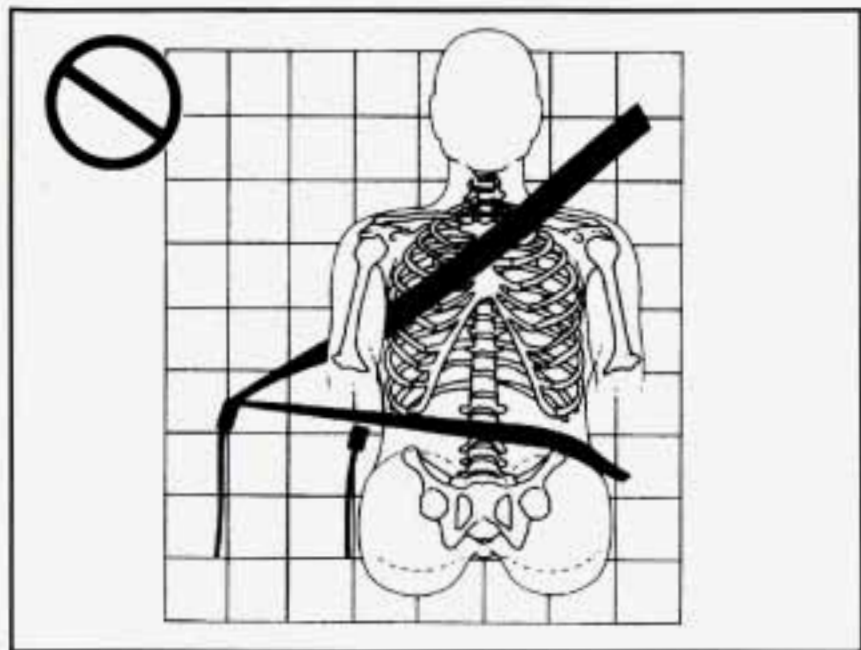

A: The belt is buckled in the wrong place.

⚠ CAUTION:

You can be seriously injured if your belt is buckled in the wrong place like this. In a crash, the belt would go up over your abdomen. The belt forces would be there, not at the pelvic bones. This could cause serious internal injuries. Always buckle your belt into the buckle nearest you.

Q: What's wrong with this?

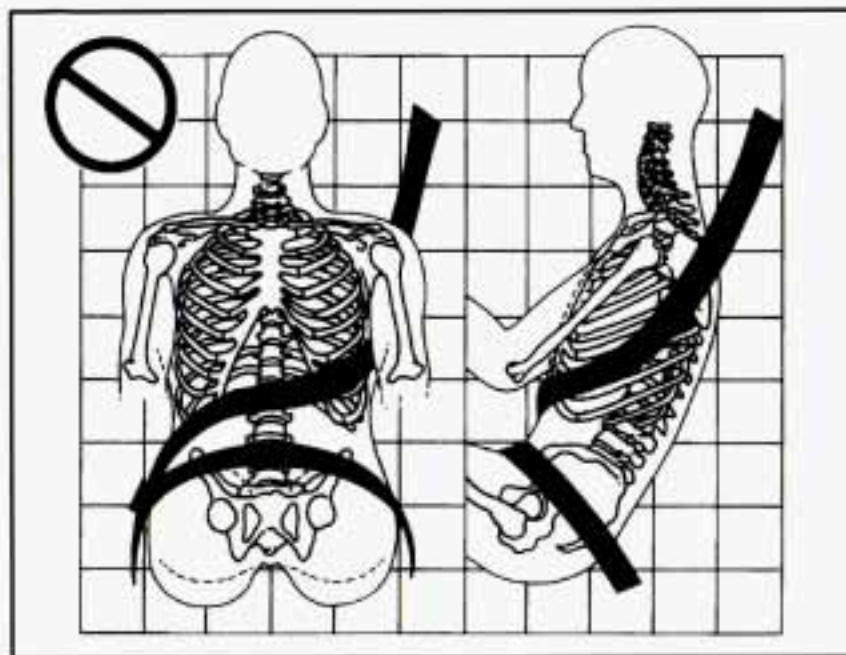

⚠ CAUTION:

You can be seriously injured if you wear the shoulder belt under your arm. In a crash, your body would move too far forward, which would increase the chance of head and neck injury. Also, the belt would apply too much force to the ribs, which aren't as strong as shoulder bones. You could also severely injure internal organs like your liver or spleen.

A: The shoulder belt is worn under the arm. It should be worn over the shoulder at all times.

Q: What's wrong with this?

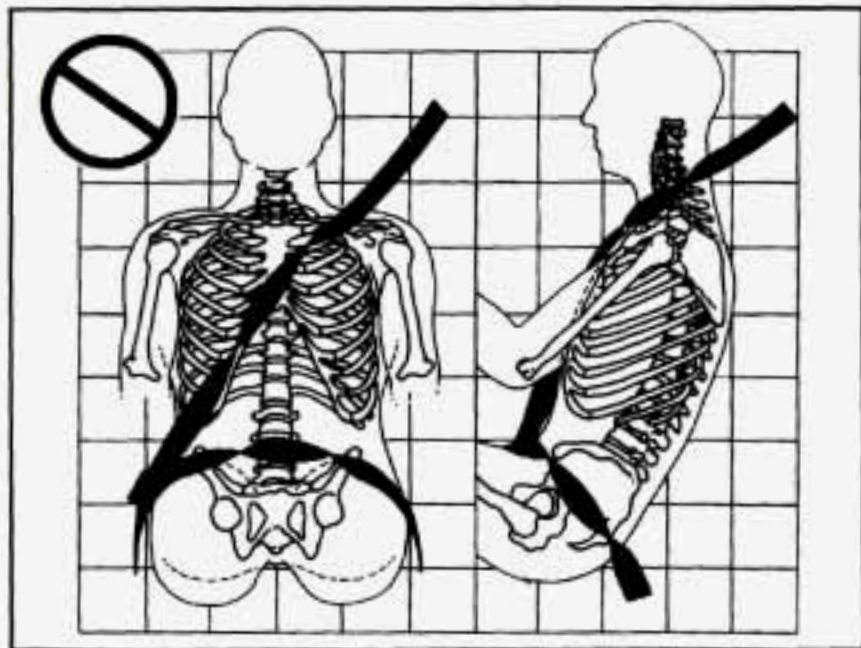

A: The belt is twisted across the body.

⚠ CAUTION:

You can be seriously injured by a twisted belt. In a crash, you wouldn't have the full width of the belt to spread impact forces. If a belt is twisted, make it straight so it can work properly, or ask your dealer to fix it.



To unlatch the belt, just push the button on the buckle. The belt should go back out of the way.

Before you close the door, be sure the belt is out of the way. If you slam the door on it, you can damage both the belt and your vehicle.

Air Bag System

This part explains the air bag system.

Your Corvette has two air bags -- one air bag for the driver and another air bag for the passenger.

Here are the most important things to know about the air bag system:

CAUTION:

You can be severely injured or killed in a crash if you aren't wearing your safety belt -- even if you have an air bag. Wearing your safety belt during a crash helps reduce your chance of hitting things inside the vehicle or being ejected from it. The air bag is only a "supplemental restraint." That is, it works with safety belts but doesn't replace them. Air bags are designed to work only in moderate to severe crashes where the front of your vehicle hits something. They aren't designed to inflate at all in rollover, rear, side or low-speed frontal crashes. Everyone in your vehicle, including the driver, should wear a safety belt properly -- whether or not there's an air bag for that person.

 **CAUTION:**

Air bags inflate with great force, faster than the blink of an eye. If you're too close to an inflating air bag, it could seriously injure you. Safety belts help keep you in position for an air bag inflation in a crash. Always wear your safety belt, even with an air bag. The driver should sit as far back as possible while still maintaining control of the vehicle.

 **CAUTION:**

An inflating air bag can seriously injure small children. Always secure children properly in your vehicle. To read how, see the part of this manual called "Children" and the caution label on the passenger's safety belt.

AIR
BAG

There is an air bag readiness light on the instrument panel, which shows AIR BAG.

The system checks the air bag's electrical system for malfunctions. The light tells you if there is an electrical problem. See "Air Bag Readiness Light" in the Index for more information.

How the Air Bag System Works



Where is the air bag?

The driver's air bag is in the middle of the steering wheel.



The passenger's air bag is in the instrument panel on the passenger's side.

 **CAUTION:**

Don't put anything on, or attach anything to, the steering wheel or instrument panel. Also, don't put anything (such as pets or objects) between any occupant and the steering wheel or instrument panel. If something is between an occupant and an air bag, it could affect the performance of the air bag -- or worse, it could cause injury.

When should an air bag inflate?

The air bag is designed to inflate in moderate to severe frontal or near-frontal crashes. The air bag will inflate only if the impact speed is above the system's designed "threshold level." If your vehicle goes straight into a wall that doesn't move or deform, the threshold level is about 9 to 15 mph (14 to 24 km/h). The threshold level can vary, however, with specific vehicle design, so that it can be somewhat above or below this range. If your vehicle strikes something that will move or deform, such as a parked car, the threshold level will be higher. The

air bag is not designed to inflate in rollovers, side impacts or rear impacts, because inflation would not help the occupant.

It is possible that in a crash only one of the two air bags in your Corvette will deploy. This is rare, but can happen in a crash just severe enough to make an air bag inflate.

In any particular crash, no one can say whether an air bag should have inflated simply because of the damage to a vehicle or because of what the repair costs were. Inflation is determined by the angle of the impact and the vehicle's deceleration. Vehicle damage is only one indication of this.

What makes an air bag inflate?

In a frontal or near-frontal impact of sufficient severity, the air bag sensing system detects that the vehicle is suddenly stopping as a result of a crash. The sensing system triggers a chemical reaction of the sodium azide sealed in the inflator. The reaction produces nitrogen gas, which inflates the air bag. The inflator, air bag and related hardware are all part of the air bag modules packed inside the steering wheel and in the instrument panel in front of the passenger.

How does an air bag restrain?

In moderate to severe frontal or near-frontal collisions, even belted occupants can contact the steering wheel or the instrument panel. The air bag supplements the protection provided by safety belts. Air bags distribute the force of the impact more evenly over the occupant's upper body, stopping the occupant more gradually. But air bags would not help you in many types of collisions, including rollovers, rear impacts and side impacts, primarily because an occupant's motion is not toward the air bag. Air bags should never be regarded as anything more than a supplement to safety belts, and then only in moderate to severe frontal or near-frontal collisions.

What will you see after an air bag inflates?

After the air bag inflates, it quickly deflates. This occurs so quickly that some people may not even realize the air bag inflated. Some components of the air bag module in the steering wheel hub for the driver's air bag, or the instrument panel for the passenger's bag, will be hot for a short time. The part of the bag that comes into contact with you may be warm, but it will never be too hot to touch. There will be some smoke and dust coming from vents in the deflated air bags. Air bag inflation will not prevent the driver from seeing or from being able to steer the vehicle, nor will it stop people from leaving the vehicle.



CAUTION:

When an air bag inflates, there is dust in the air. This dust could cause breathing problems for people with a history of asthma or other breathing trouble. To avoid this, everyone in the vehicle should get out as soon as it is safe to do so. If you have breathing problems but can't get out of the vehicle after an air bag inflates, then get fresh air by opening a window or door.

In many crashes severe enough to inflate an air bag, windshields are broken by vehicle deformation. Additional windshield breakage may also occur from the passenger air bag.

- The air bags are designed to inflate only once. After they inflate, you'll need some new parts for your air bag system. If you don't get them, the air bag system won't be there to help protect you in another crash. A new system will include air bag modules and possibly other parts. The service manual for your vehicle covers the need to replace other parts.

- Your vehicle is equipped with a diagnostic module, which records information about the air bag system. The module records information about the readiness of the system, when the sensors are activated and driver's safety belt usage at deployment.
- Let only qualified technicians work on your air bag system. Improper service can mean that your air bag system won't work properly. See your dealer for service.

NOTICE:

If you damage the cover for the driver's or the passenger's air bag, they may not work properly. You may have to replace the air bag module in the steering wheel or both the air bag module and the instrument panel for the passenger's air bag. Do not open or break the air bag covers.

Servicing Your Air Bag-Equipped Corvette

Air bags affect how your Corvette should be serviced. There are parts of the air bag system in several places around your vehicle. You don't want the system to inflate while someone is working on your vehicle. Your Corvette dealer and the Corvette Service Manual have information about servicing your vehicle and the air bag system. To purchase a service manual, see "Service and Owner Publications" in the Index.

CAUTION:

For up to two minutes after the ignition key is turned off and the battery is disconnected, an air bag can still inflate during improper service. You can be injured if you are close to an air bag when it inflates. Avoid yellow wires, wires wrapped with yellow tape or yellow connectors. They are probably part of the air bag system. Be sure to follow proper service procedures, and make sure the person performing work for you is qualified to do so.

The air bag system does not need regular maintenance.

Safety Belt Use During Pregnancy

Safety belts work for everyone, including pregnant women. Like all occupants, they are more likely to be seriously injured if they don't wear safety belts.



A pregnant woman should wear a lap-shoulder belt, and the lap portion should be worn as low as possible, below the rounding, throughout the pregnancy.

The best way to protect the fetus is to protect the mother. When a safety belt is worn properly, it's more likely that the fetus won't be hurt in a crash. For pregnant women, as for anyone, the key to making safety belts effective is wearing them properly.

Passenger Position

The passenger's safety belt works the same way as the driver's safety belt. See "Driver Position," earlier in this section.

Children

Everyone in a vehicle needs protection! That includes infants and all children smaller than adult size. In fact, the law in every state in the United States and in every Canadian province says children up to some age must be restrained while in a vehicle.

Smaller Children and Babies



CAUTION:

A very young child's hip bones are so small that a regular belt might not stay low on the hips, as it should. Instead, the belt will likely be over the child's abdomen. In a crash, the belt would apply force right on the child's abdomen, which could cause serious or fatal injuries. Smaller children and babies should always be restrained in a child restraint. However, infants, who should be restrained in a rear-facing child restraint, cannot ride safely in this vehicle. The instructions for the restraint will say whether it is the right type and size for your child. If a forward-facing child restraint is suitable for your child, be sure the child is always properly restrained while riding in this vehicle.



⚠ CAUTION:

Never hold a baby in your arms while riding in a vehicle. A baby doesn't weigh much -- until a crash. During a crash a baby will become so heavy you can't hold it. For example, in a crash at only 25 mph (40 km/h), a 12-lb. (5.5 kg) baby will suddenly become a 240-lb. (110 kg) force on your arms. The baby would be almost impossible to hold.

Child Restraints

Be sure the child restraint is designed to be used in a vehicle. If it is, it will have a label saying that it meets Federal Motor Vehicle Safety Standards.

Then follow the instructions for the restraint. You may find these instructions on the restraint itself or in a booklet, or both. These restraints use the belt system in your vehicle, but the child also has to be secured within the restraint to help reduce the chance of personal injury. The instructions that come with the child restraint will show you how to do that.

The child restraint must be secured properly in the passenger seat.

Keep in mind that an unsecured child restraint can move around in a collision or sudden stop and injure people in the vehicle. Be sure to properly secure any child restraint in your vehicle -- even when no child is in it.

Top Strap

Some child restraints have a top strap. Don't use a restraint like that in your vehicle because the top strap anchor cannot be installed properly. You shouldn't use this type of child restraint without anchoring the top strap.

Securing a Child Restraint in the Passenger Seat Position

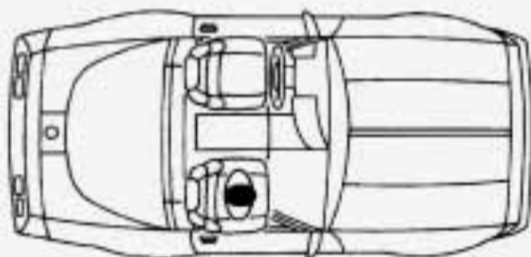

Your vehicle has a passenger air bag. *Never* put a rear-facing child restraint in this vehicle. Here's why:

 **CAUTION:**

A child in a rear-facing child restraint can be seriously injured if the passenger's air bag inflates. This is because the back of a rear-facing child restraint would be very close to the inflating air bag. Do not use a rear-facing child restraint in this vehicle.

If a forward-facing child restraint is suitable for your child, always move the passenger seat as far back as it will go.

You'll be using the lap-shoulder belt. See the earlier part about the top strap if the child restraint has one.

1. Because your vehicle has a passenger air bag, always move the seat as far back as it will go before securing a forward-facing child restraint. (See "Seats" in the Index.)
2. Put the restraint on the seat. Follow the instructions for the child restraint.
3. Secure the child in the child restraint as the instructions say.
4. Pick up the latch plate, and run the lap and shoulder portions of the vehicle's safety belt through or around the restraint. The child restraint instructions will show you how.

If the shoulder belt goes in front of the child's face or neck, put it behind the child restraint.



5. Buckle the belt. Make sure the release button is positioned so you would be able to unbuckle the safety belt quickly if you ever had to.

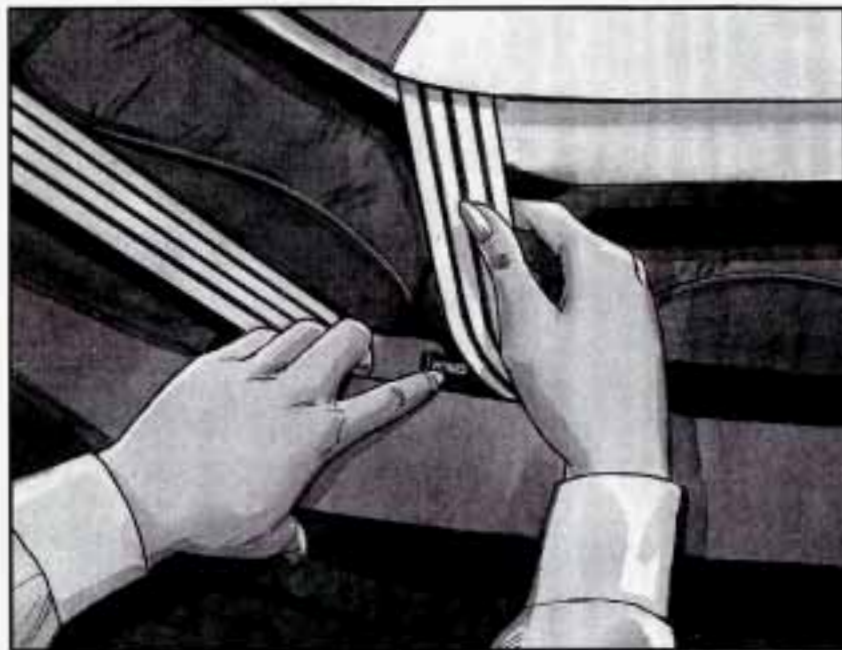

6. Push the CINCH button. See “Lap Belt Cinch Feature” in the Index, where we describe the cinch feature.
7. To tighten the belt, feed the lap belt back into the retractor while you push down on the child restraint.
8. Push and pull the child restraint in different directions to be sure it is secure.

To remove the child restraint, just unbuckle the vehicle’s safety belt and let it go back all the way. The safety belt will move freely again and be ready to work for an adult or larger child passenger.

Larger Children



Children who have outgrown child restraints should wear the vehicle's safety belts.

- Children who aren't buckled up can be thrown out in a crash.
- Children who aren't buckled up can strike other people who are.



CAUTION:

Never do this.

Here two children are wearing the same belt. The belt can't properly spread the impact forces. In a crash, the two children can be crushed together and seriously injured. A belt must be used by only one person at a time.

Q: What if a child is wearing a lap-shoulder belt, but the child is so small that the shoulder belt is very close to the child's face or neck?

A: Move the child toward the center of the vehicle, but be sure that the shoulder belt still is on the child's shoulder, so that in a crash the child's upper body would have the restraint that belts provide.



⚠ CAUTION:

Never do this.

Here a child is sitting in a seat that has a lap-shoulder belt, but the shoulder part is behind the child. If the child wears the belt in this way, in a crash the child might slide under the belt. The belt's force would then be applied right on the child's abdomen. That could cause serious or fatal injuries.

The lap portion of the belt should be worn low and snug on the hips, just touching the child's thighs. This applies belt force to the child's pelvic bones in a crash.

Safety Belt Extender

If the vehicle's safety belt will fasten around you, you should use it.

But if a safety belt isn't long enough to fasten, your dealer will order you an extender. It's free. When you go in to order it, take the heaviest coat you will wear, so the extender will be long enough for you. The extender will be just for you, and just for the seat in your vehicle that you choose. Don't let someone else use it, and use it only for the seat it is made to fit. To wear it, just attach it to the regular safety belt.

Checking Your Restraint Systems

Now and then, make sure the safety belt reminder light and all your belts, buckles, latch plates, retractors and anchorages are working properly. Look for any other loose or damaged safety belt system parts. If you see anything that might keep a safety belt system from doing its job, have it repaired.

Torn or frayed safety belts may not protect you in a crash. They can rip apart under impact forces. If a belt is torn or frayed, get a new one right away.

Also look for any opened or broken air bag covers, and have them repaired or replaced. (The air bag system does not need regular maintenance.)

Replacing Restraint System Parts After a Crash

If you've had a crash, do you need new belts?

After a very minor collision, nothing may be necessary. But if the belts were stretched, as they would be if worn during a more severe crash, then you need new belts.



If you ever see a label on the passenger's safety belt that says to replace the belt, be sure to do so. Then the new belt will be there to help protect you in a collision. You would see this label on the belt near the latch plate.

If belts are cut or damaged, replace them. Collision damage also may mean you will need to have safety belt or seat parts repaired or replaced. New parts and repairs may be necessary even if the belt wasn't being used at the time of the collision.

If an air bag inflates, you'll need to replace air bag system parts. See the part on the air bag system earlier in this section.



Section 2 Features and Controls

Here you can learn about the many standard and optional features on your Corvette, and information on starting, shifting and braking. Also explained are the instrument panel and the warning systems that tell you if everything is working properly -- and what to do if you have a problem.

Keys

CAUTION:

Leaving young children in a vehicle with the ignition key is dangerous for many reasons. A child or others could be badly injured or even killed.

They could operate power windows or other controls or even make the vehicle move. Don't leave the keys in a vehicle with young children.



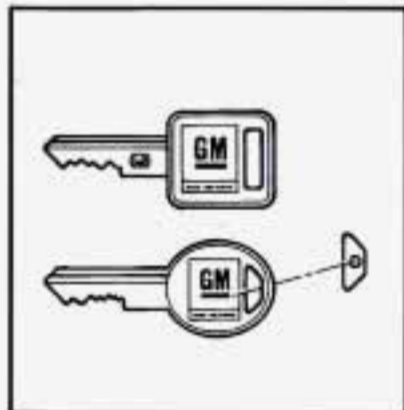

The square keys are for the ignition only, and the oval keys are for the doors and all other locks.

When a new Corvette is delivered, the dealer removes the plugs from the keys, and gives them to the first owner. However, the ignition key may not have a plug. If the ignition key doesn't have a plug, there will be a bar-coded key tag instead.

Each plug or tag has a code on it that tells your dealer or a qualified locksmith how to make extra keys. Keep the plugs in a safe place. If you lose your keys, you'll be able to have new ones made easily using these plugs. If your ignition keys don't have plugs, go to your Chevrolet dealer for the correct key code if you need a new ignition key.

NOTICE:

Your Corvette has a number of features that can help prevent theft. But you can have a lot of trouble getting into your vehicle if you ever lock your keys inside. You may even have to damage your vehicle to get in. So be sure you have extra keys.

Door Locks

CAUTION:

Unlocked doors can be dangerous.

Passengers -- especially children -- can easily open the doors and fall out. When a door is locked, the inside handle won't open it.

Outsiders can easily enter through an unlocked door when you slow down or stop your vehicle.

This may not be so obvious: You increase the chance of being thrown out of the vehicle in a crash if the doors aren't locked. Wear safety belts properly, lock your doors, and you will be far better off whenever you drive your vehicle.

There are several ways to lock and unlock your vehicle.

From the outside, use your door key or the Passive Keyless Entry transmitter.

If your theft-deterrent system is armed, unlock the doors only with the key or the transmitter to avoid setting off the alarm. See "Universal Theft-Deterrent" in the Index.

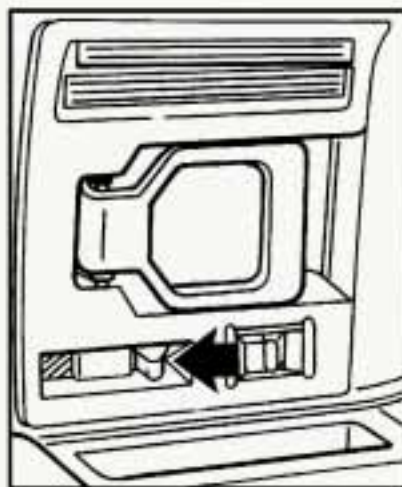

To lock the door from the inside, move the lock control on the door backward. To unlock it, move the lock control on the door forward.

Power Door Locks

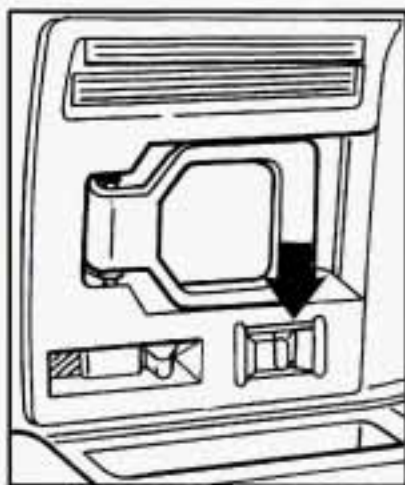

Push the power door lock switch on either door backward to lock or forward to unlock both doors at once.

Leaving Your Vehicle

If you are leaving the vehicle, take your keys, open your door and set the locks from inside. Then get out and close the door.

Your vehicle has a theft-deterrent system. See "Universal Theft-Deterrent" in the Index.

Passive Keyless Entry System

Your Corvette's Passive Keyless Entry System (PKE) allows you to lock and unlock your doors, unlock your trunk or hatch, or disarm or arm your theft-deterrent system from as much as three to seven feet (one to two meters) away when using the key chain transmitter supplied with your vehicle.



Your Corvette comes standard with one PKE transmitter. An additional transmitter is optional, and up to three can be matched to your vehicle.

See "Matching Transmitter(s) to Your Vehicle" later in this section.

Your Passive Keyless Entry system operates on a radio frequency subject to Federal Communications Commission (FCC) Rules.

This device complies with Part 15 of the FCC Rules.

Operation is subject to the following two conditions:

- (1) This device may not cause harmful interference, and
- (2) This device must accept any interference received, including interference that may cause undesired operation.

Should interference to this system occur, try this:

- Check to determine if battery replacement is necessary. See the instructions on battery replacement.
- Check the distance. You may be too far from your vehicle. This product has a maximum range.
- Check the location. Other vehicles or objects may be blocking the signal.
- See your Chevrolet dealer or a qualified technician for service.

Changes or modifications to this system by anyone other than an authorized service facility could void authorization to use this equipment.

Operation

You don't have to do anything for PKE to work when the passive feature is on. Just move toward your vehicle with the PKE transmitter, and the system will automatically disarm your theft-deterrent system and unlock the doors. If it's dark enough outside, your interior lamps will come on.

If you move out of range, the PKE system will:

1. Lock the doors after five seconds.
2. Arm the theft-deterrent system.
3. Sound the horn to let you know the doors are locked.
4. Turn off the interior lamps.

You can also use the buttons on the transmitter. Press DOOR to open the passenger's door or HATCH to open the hatch. The HATCH button will only work when the ignition is off.

The system has a feature that makes it difficult for you to lock your keys in your vehicle. If you leave your keys in the ignition and lock the doors, the system will unlock the doors as soon as they are closed. If you leave the keys in the ignition and move away with the transmitter, the doors still will not lock. You should notice that the horn doesn't sound and return to get your keys.

The system will allow you to lock your keys in the vehicle if you didn't leave them in the ignition. You should, however, be able to use the transmitter to get them out. After 26 seconds of no motion, the transmitter shuts down to save the battery. Wait about 30 seconds, then rock the vehicle. The transmitter should "wake up" and unlock the doors.

This system can't guarantee that you'll never be locked out of your vehicle. If the battery is low or if the transmitter is in a place where the signal can't get to the antenna, it won't unlock the doors. Always remember to take your keys with you.

PKE Settings

You can use the system for both doors or just the driver's door, or you can turn the system off.

Changing the Door Settings

1. Put the ignition key in the ignition, but don't turn it on.
2. Press DOOR on the transmitter until the door locks cycle (about two seconds).

Turning the System Off

1. Take the ignition key out of the ignition.
2. Press DOOR on the transmitter until the door locks cycle (about two seconds).

To turn the system back on, just repeat the steps.

To check that the system is off, turn on the ignition. The PASSIVE KEYLESS ENTRY light on the Driver Information Center should not come on. If the light does come on for a second or two, then the PKE system is still on.

You can also check whether the system is on or off by closing the door and moving away from the vehicle with the keys and transmitter. If the doors lock, the system is on.

If you are working around your vehicle and keeping your keys with you, you might want to turn the PKE system off. If you don't, the transmitter will keep locking and unlocking your doors.

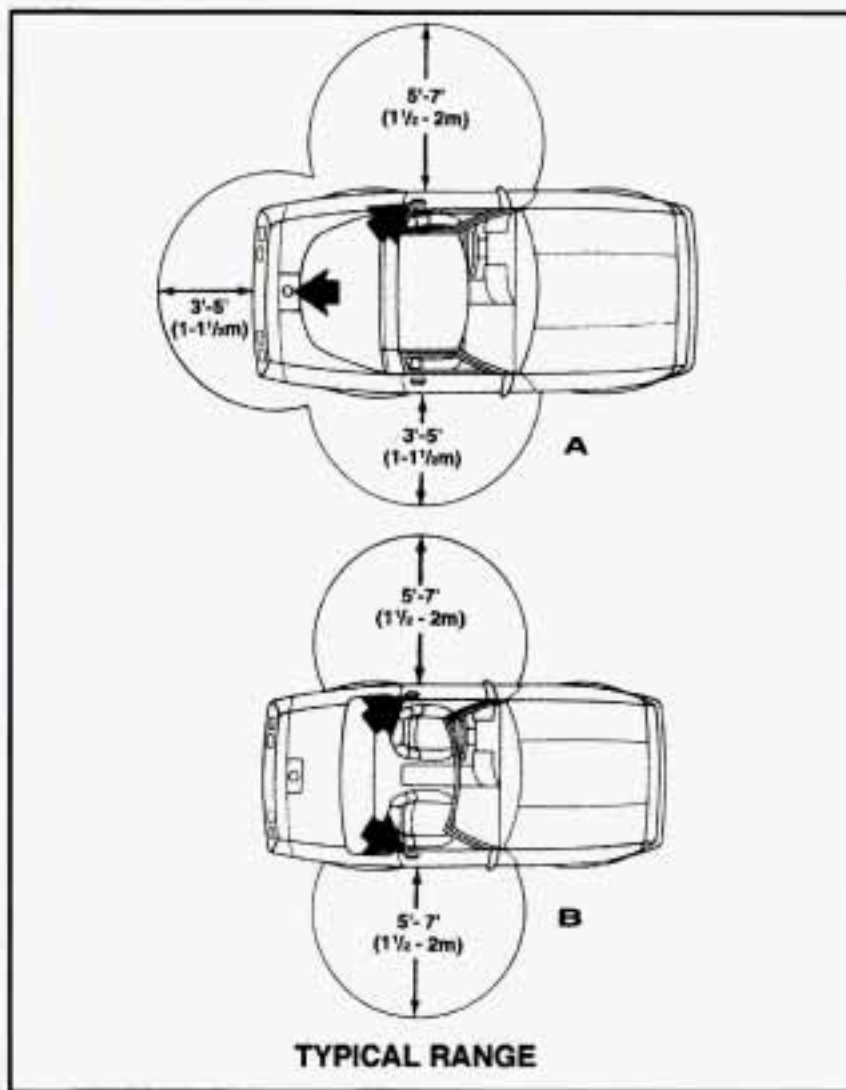

Transmitter Range

The transmitter range depends on your vehicle and where you are standing. The coupe (A) has an antenna in the driver's door and one in the rear area. The convertible (B) has one antenna in each door. The antennas do not require any maintenance.

Range also depends on how you hold the transmitter. For best performance, when you come near your vehicle, hold the transmitter straight up and down, so the keys hang down.

If the range seems to be decreasing, check the battery in the transmitter. Range will decrease if the battery is low. It will also decrease if more than one transmitter is in the area. Don't put the transmitter in a metal container because the transmitter won't work.

Matching Transmitter(s) To Your Vehicle

Each key chain transmitter is coded to prevent another transmitter from unlocking your vehicle. If a transmitter is lost or stolen, a replacement can be purchased through your dealer. Remember to bring any remaining transmitters with you when you go to your dealer. When the dealer matches the replacement transmitter to your vehicle, any remaining transmitters must also be matched. Once the new transmitter is coded, the lost transmitter will not unlock your vehicle. Each vehicle can have only three transmitters matched to it.

To match transmitters to your vehicle:

1. Move all transmitters out of range.
2. Turn the ignition key on.
3. Push TRIP ODO on the Driver Information Center twice.
4. Within five seconds, press and hold FUEL INFO until the PASSIVE KEYLESS ENTRY light comes on.

5. Turn the ignition off, but leave the key in the ignition. The PASSIVE KEYLESS ENTRY light should begin to flash to show the system is in programming mode.
6. Bring one transmitter into range. The light will stop flashing and stay on to show that the code is stored.
7. Move the transmitter out of range. The light should start flashing again.
8. Repeat Steps 6 and 7 with each additional transmitter.

The programming mode will shut off if:

- You don't program any transmitters for two minutes.
- You take the key out of the ignition or turn the ignition on.
- You have programmed three transmitters.

Battery Replacement

Under normal use, the battery in your key chain transmitter should last about 18 months.

You can tell the battery is weak if the transmitter won't work at the normal range in any location. If you have to get close to your vehicle before the transmitter works, it's probably time to change the battery.

Replacing Your Battery

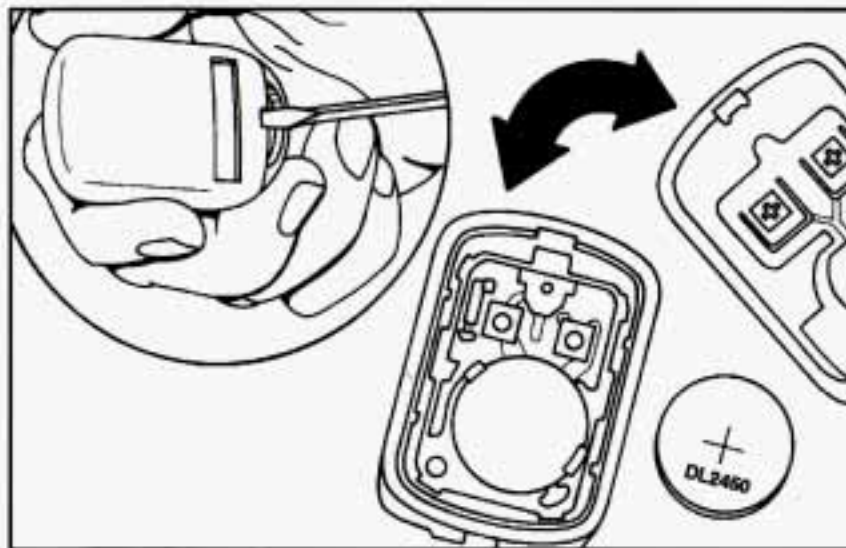

1. Insert a screwdriver into the slot on the back of the transmitter and gently pry apart the front and back.
2. Gently pry the battery out of the transmitter using the screwdriver.
3. Put the new battery in the transmitter, positive (+) side up. Use a Duracell® battery, type DL2450, or equivalent.
4. Put the two halves back together. Make sure the halves are together tightly so water won't get in.
5. Test the transmitter.

Remote Hatch Release

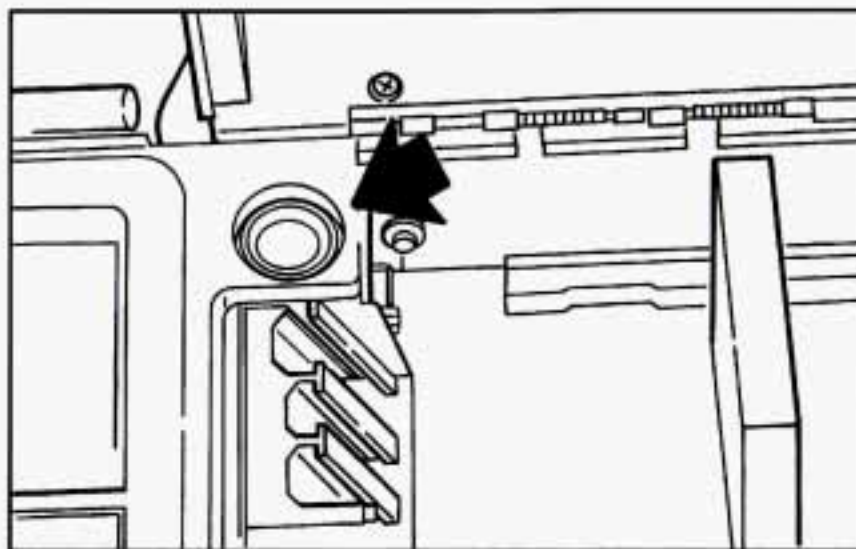

Press the switch in your center console to unlock the hatch from inside your vehicle. If you have an automatic transmission, your shift lever must be in PARK (P) or NEUTRAL (N) to use the switch. If you have a manual transmission, you must set the parking brake before you can use the switch when the vehicle is running. If you have a manual transmission and the vehicle is not running, you may use the switch in any gear.



If you have a coupe, this switch is on the rear of the driver's door. It works with the door open and the transmission in any gear. Push it down to release the hatch.

The PKE transmitter will also release the hatch. See "Passive Keyless Entry System" in the Index.

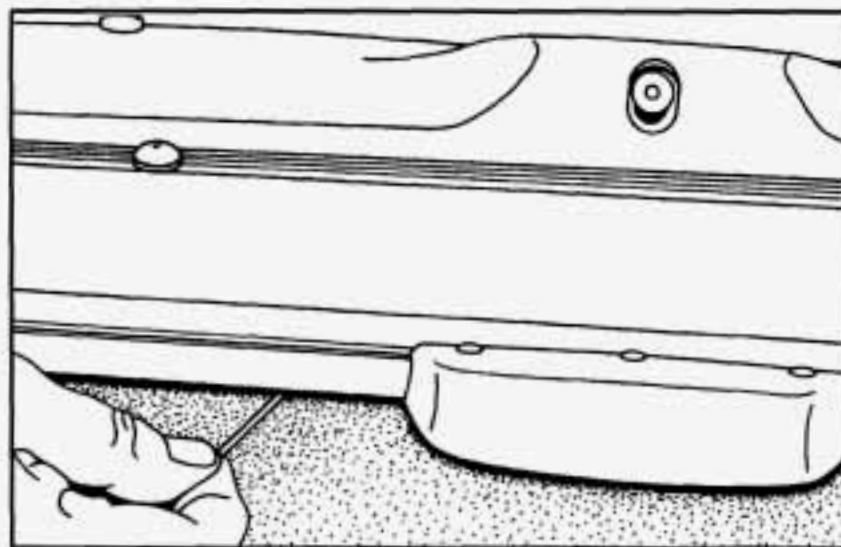

If you don't have battery power, use the manual release cable to open the hatch. The cable is near the security shade handle, between the carpet and the shade.



CAUTION:

It can be dangerous to drive with the hatch open because carbon monoxide (CO) gas can come into your vehicle. You can't see or smell CO. It can cause unconsciousness and even death.

If you must drive with the hatch open or if electrical wiring or other cable connections must pass through the seal between the body and the hatch:

- Make sure all windows are shut.
- Turn the fan on your heating or cooling system to its highest speed with the setting on bi-level or vent. That will force outside air into your vehicle. See "Comfort Controls" in the Index.
- If you have air outlets on or under the instrument panel, open them all the way.

See "Engine Exhaust" in the Index.

NOTICE:

If you put things in the hatchback area, be sure they won't break the glass when you close it.

Never slam the hatch down. You could break the glass or damage the defogger grid.

When you close the hatch, make sure you pull down from the center, not the sides. If you pull the hatch down from the side too often, the weatherstrip can be damaged.

Theft

Vehicle theft is big business, especially in some cities. Although your Corvette has a number of theft-deterrent features, we know that nothing we put on it can make it impossible to steal. However, there are ways you can help.

Key in the Ignition

If you leave your vehicle with the keys inside, it's an easy target for joy riders or professional thieves -- so don't do it.

When you park your Corvette and open the driver's door, you'll hear a tone reminding you to remove your key from the ignition and take it with you. Always do this. Your steering wheel will be locked, and so will your ignition. If you have an automatic transmission, taking your key out also locks your transmission. And remember to lock the doors.

Parking at Night

Park in a lighted spot, close all windows and lock your vehicle. Remember to keep your valuables out of sight. Put them in a storage area, or take them with you.

Parking Lots

If you park in a lot where someone will be watching your vehicle, it's best to lock it up and take your keys. But what if you have to leave your ignition key? What if you have to leave something valuable in your vehicle?

- Put your valuables in a storage area, like your rear storage compartment or center console.
- Lock the rear storage compartment and center console.
- Lock all the doors except the driver's.
- Then take the door key with you.

Universal Theft-Deterrent System



SECURITY

Your Corvette has a theft-deterrent alarm system. With this system, the SECURITY light will flash as you open the door (if your ignition is off). This light reminds you to arm the theft-deterrent system.

Here's how to do it:

1. Open the door.
2. Lock the door with the power door lock switch or Passive Keyless Entry system. The SECURITY light will come on.
3. Close all the doors. The SECURITY light should go off.

Now, if a door or the hatch is opened without the key or Passive Keyless Entry system, the alarm will go off.

Your horn will sound for three minutes, then it will go off to save battery power. And, your vehicle won't start.

The theft-deterrent system won't arm if you lock the doors with a key or manual door lock, or if you lock the vehicle after the doors are closed.

If your passenger stays in the vehicle when you leave with the keys, have the passenger lock the vehicle after the doors are closed. This way the alarm won't arm, and your passenger won't set it off.

Always use your key or the Passive Keyless Entry system to unlock a door. Unlocking a door any other way will set off the alarm. If you do set off the alarm accidentally, there are three ways to stop it:

- Unlock any door with your key.
- Put the ignition key in the ignition.
- Use the Passive Keyless Entry system.

Testing the Alarm

1. Make sure the rear hatch is latched.
2. Lower a window.
3. Arm the system.
4. Close the doors and wait five seconds.
5. Reach through the open window and unlock the door from inside. The alarm should sound.
6. Turn off the alarm.

If the alarm is inoperative, check to see if the horn works. If not, check the horn fuse. See "Fuses and Circuit Breakers" in the Index. If the horn does work, but the alarm doesn't go off, see your dealer.

PASS-Key®



Your vehicle is equipped with the PASS-Key (Personalized Automotive Security System) theft-deterrent system. PASS-Key is a passive theft-deterrent system. It works when you insert or remove the key from the ignition.

PASS-Key uses a resistor pellet in the ignition key that matches a decoder in your vehicle.

When the PASS-Key system senses that someone is using the wrong key, it shuts down the vehicle's starter and fuel systems. For about three minutes, the starter won't work and fuel won't go to the engine. If someone tries to start your vehicle again or uses another key during this time, the shutdown period will start over again. This discourages someone from randomly trying different keys with different resistor pellets in an attempt to make a match.

The ignition key must be clean and dry before it's inserted in the ignition or the engine may not start. If the SECURITY light comes on, the key may be dirty or wet.

If this happens and the starter won't work, turn the ignition off. Clean and dry the key, wait three minutes and try again. If the starter still won't work, wait three minutes and try the other ignition key. At this time, you may also want to check the fuses (see "Fuses and Circuit Breakers" in the Index). If the starter won't work with the other key, your vehicle needs service. If your vehicle does start, the first ignition key may be faulty. See your Chevrolet dealer or a locksmith who can service the PASS-Key.

However, if you accidentally use a key that has a damaged or missing resistor pellet, you will see no SECURITY light. You don't have to wait three minutes before trying the proper key.

If the resistor pellet is damaged or missing, the starter won't work. Use the other ignition key, and see your Chevrolet dealer or a locksmith who can service the PASS-Key to have a new key made.

If the SECURITY light comes on while driving, have your vehicle serviced as soon as possible.

If you lose or damage a PASS-Key ignition key, see your Chevrolet dealer or a locksmith who can service PASS-Key. In an emergency, call the Chevrolet Roadside Assistance Program at 1-800-CHEV-USA (1-800-243-8872).

New Vehicle "Break-In"

NOTICE:

Your modern Corvette doesn't need an elaborate "break-in." But it will perform better in the long run if you follow these guidelines:

- **Keep your speed at 55 mph (88 km/h) or less for the first 500 miles (804 km).**
- **Don't drive at any one speed -- fast or slow -- for the first 500 miles (804 km). Don't make full-throttle starts.**
- **Avoid making hard stops for the first 200 miles (322 km) or so. During this time your new brake linings aren't yet broken in. Hard stops with new linings can mean premature wear and earlier replacement. Follow this "breaking-in" guideline every time you get new brake linings.**

Ignition Positions

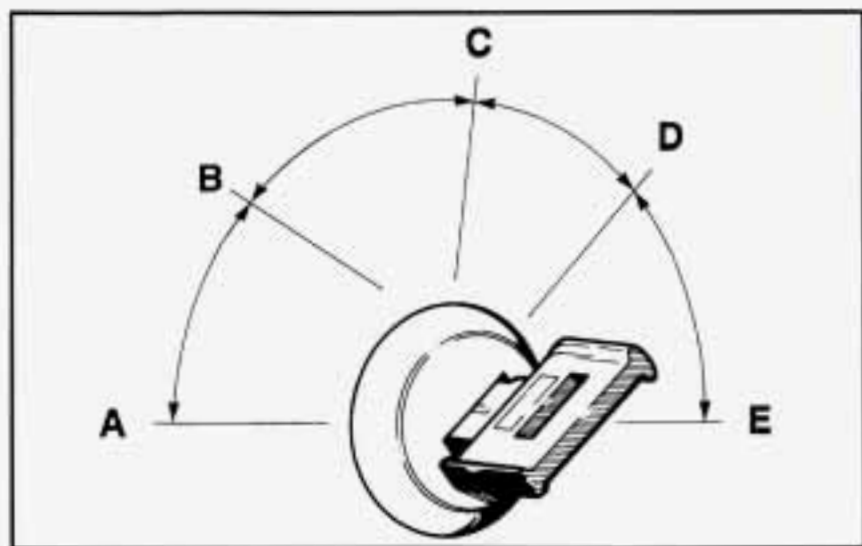

With the ignition key in the ignition switch, you can turn the switch to five positions.

ACC (A): Position in which you can operate your electrical power accessories. Press in the ignition switch as you turn the top of it toward you.

LOCK (B): The only position in which you can remove the key. This locks your steering wheel, ignition and automatic transmission.

If you have an automatic transmission, the ignition switch can't be turned to LOCK unless the shift lever is in the PARK (P) position.

OFF (C): Unlocks the steering wheel, ignition and automatic transmission, but does not send electrical power to any accessories. Use this position if your vehicle must be pushed or towed.

RUN (D): Position to which the switch returns after you start your engine and release the switch. The switch stays in the RUN position when the engine is running. But even when the engine is not running, you can use RUN to operate your electrical power accessories and to display some instrument panel warning and indicator lights.

START (E): Starts the engine. When the engine starts, release the key. The ignition switch will return to RUN for normal driving.

When the engine is not running, ACC and RUN allow you to operate your electrical accessories, such as the radio.

A warning tone will sound if you open the driver's door when the ignition is in OFF, LOCK or ACC and the key is in the ignition.

Key Release Button

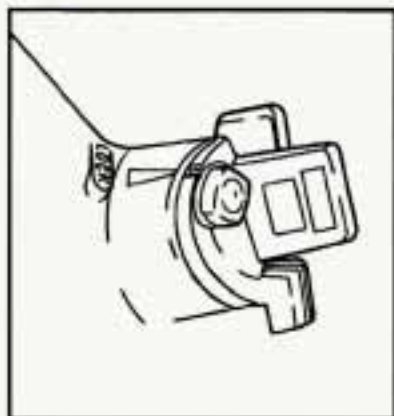

If you have a manual transmission, your ignition lock has a key release button. You must press the button before you can take your key out of the ignition lock.

CAUTION:

On manual transmission vehicles, turning the key to LOCK will lock the steering column and result in a loss of ability to steer the vehicle. This could cause a collision. If you need to turn the engine off while the vehicle is moving, turn the key only to OFF. Don't press the key release button while the vehicle is moving.

NOTICE:

If your key seems stuck in LOCK and you can't turn it, be sure it is all the way in. If it is, then turn the steering wheel left and right while you turn the key hard. But turn the key only with your hand. Using a tool to force it could break the key or the ignition switch. If none of this works, then your vehicle needs service.

Delayed Accessory Bus (DAB)

With DAB, your power windows and the audio system will continue to work up to 15 minutes after the ignition key is turned to OFF and neither door is opened. If a door is opened, the audio system and power windows will shut off.

Starting Your Engine

Automatic Transmission

Move your shift lever to PARK (P) or NEUTRAL (N). Your engine won't start in any other position -- that's a safety feature. To restart when you're already moving, use NEUTRAL (N) only.

NOTICE:

Don't try to shift to PARK (P) if your Corvette is moving. If you do, you could damage the transmission. Shift to PARK (P) only when your vehicle is stopped.

Manual Transmission

The gear selector should be in NEUTRAL (N). Hold the clutch pedal to the floor and start the engine. Your vehicle won't start if the clutch pedal is not all the way down -- that's a safety feature.

Starting Your Engine

1. Without pushing the accelerator pedal, turn the ignition key to START. When the engine starts, let go of the key. The idle speed will go down as your engine gets warm.

NOTICE:

Holding your key in START for longer than 15 seconds at a time will cause your battery to be drained much sooner. And the excessive heat can damage your starter motor.

2. If it doesn't start within 10 seconds, push the accelerator pedal all the way to the floor, while you hold the ignition key in START. When the engine starts, let go of the key and let up on the accelerator pedal. Wait about 15 seconds between each try to help avoid draining your battery.

When starting your engine in very cold weather (below 0°F or -18°C), do this:

1. With your foot off the accelerator pedal, turn the ignition key to START and hold it there. When the engine starts, let go of the key. Use the accelerator pedal to maintain engine speed, if you have to, until your engine has run for a while.
2. If your engine still won't start (or starts but then stops), it could be flooded with too much gasoline. Try pushing your accelerator pedal all the way to the floor and holding it there as you hold the key in

START for about three seconds. If the vehicle starts briefly but then stops again, do the same thing, but this time keep the pedal down for five or six seconds. This clears the extra gasoline from the engine.

NOTICE:

Your engine is designed to work with the electronics in your vehicle. If you add electrical parts or accessories, you could change the way the engine operates. Before adding electrical equipment, check with your dealer. If you don't, your engine might not perform properly.

If you ever have to have your vehicle towed, see the part of this manual that tells how to do it without damaging your vehicle. See "Towing Your Vehicle" in the Index.

Racing or Other Competitive Driving

See your Warranty Book before using your Corvette for racing or other competitive driving.

NOTICE:

If you use your Corvette for racing or other competitive driving, your engine may use more oil than it would with normal use. Low oil levels can damage the engine. Be sure to check the oil level often during racing or other competitive driving and keep the level at or near the upper mark on the engine oil dipstick. You may need to add oil. See "Engine Oil" in the Index.

Engine Coolant Heater (Canada Only)

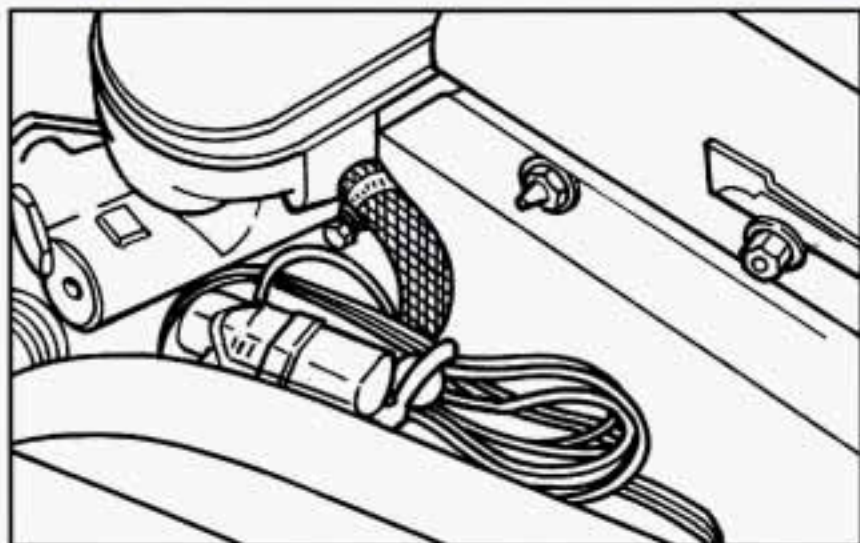

In very cold weather, 0°F (-18°C) or colder, the engine coolant heater can help. You'll get easier starting and better fuel economy during engine warm-up. Usually, the coolant heater should be plugged in a minimum of four hours prior to starting your vehicle.

To Use the Coolant Heater

1. Turn off the engine.
2. Open the hood and unwrap the electrical cord.
3. Plug it into a normal, grounded 110-volt AC outlet.

CAUTION:

Plugging the cord into an ungrounded outlet could cause an electrical shock. Also, the wrong kind of extension cord could overheat and cause a fire. You could be seriously injured. Plug the cord into a properly grounded three-prong 110-volt AC outlet. If the cord won't reach, use a heavy-duty three-prong extension cord rated for at least 15 amps.

4. After you've used the coolant heater, be sure to store the cord as it was before to keep it away from moving engine parts. If you don't, it could be damaged.

How long should you keep the coolant heater plugged in? The answer depends on the outside temperature, the kind of oil you have, and some other things. Instead of trying to list everything here, we ask that you contact your Chevrolet dealer in the area where you'll be parking your vehicle. The dealer can give you the best advice for that particular area.

Automatic Transmission Operation

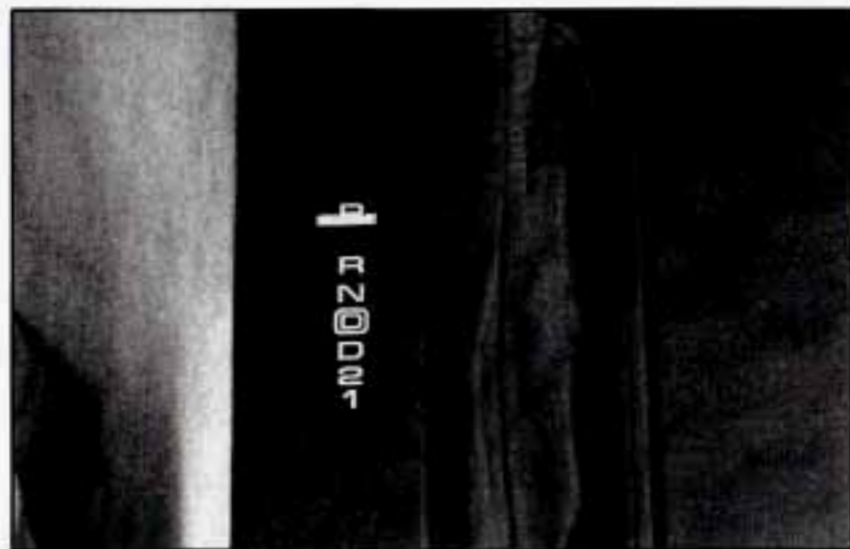

There are several different positions for your shift lever.

PARK (P): This locks your rear wheels. It's the best position to use when you start your engine because your vehicle can't move easily.



CAUTION:

It is dangerous to get out of your vehicle if the shift lever is not fully in PARK (P) with the parking brake firmly set. Your vehicle can roll. Don't leave your vehicle when the engine is running unless you have to. If you have left the engine running, the vehicle can move suddenly. You or others could be injured. To be sure your vehicle won't move, even when you're on fairly level ground, always set your parking brake and move the shift lever to PARK (P).

See "Shifting Into PARK (P)" in the Index.

Ensure the shift lever is fully in PARK (P) range before starting the engine. Your Corvette has a brake-transmission shift interlock. You have to fully apply your regular brakes before you can shift from PARK (P) when the ignition key is in the RUN position. If you cannot shift out of PARK (P), ease pressure on the shift lever -- push the shift lever all the way into PARK (P) and release the shift lever button as you

maintain brake application. Then press the shift lever button and move the shift lever into the gear you wish. See “Shifting Out of PARK (P)” in the Index.

REVERSE (R): Use this gear to back up.

NOTICE:

Shifting to REVERSE (R) while your vehicle is moving forward could damage your transmission. Shift to REVERSE (R) only after your vehicle is stopped.

To rock your vehicle back and forth to get out of snow, ice or sand without damaging your transmission, see “Stuck: In Sand, Mud, Ice or Snow” in the Index.

NEUTRAL (N): In this position, your engine doesn't connect with the wheels. To restart when you're already moving, use NEUTRAL (N) only. Also, use NEUTRAL (N) when your vehicle is being towed.



CAUTION:

Shifting out of PARK (P) or NEUTRAL (N) while your engine is “racing” (running at high speed) is dangerous. Unless your foot is firmly on the brake pedal, your vehicle could move very rapidly. You could lose control and hit people or objects. Don't shift out of PARK (P) or NEUTRAL (N) while your engine is racing.

NOTICE:

Damage to your transmission caused by shifting out of PARK (P) or NEUTRAL (N) with the engine racing isn't covered by your warranty.

AUTOMATIC OVERDRIVE (Ⓢ): This position is for normal driving. If you need more power for passing, and you're:

- Going less than about 35 mph (56 km/h), push your accelerator pedal about halfway down.
- Going about 35 mph (56 km/h) or more, push the accelerator all the way down.

You'll shift down to the next gear and have more power.

DRIVE (D): This position is also used for normal driving, however, it offers more power and lower fuel economy than AUTOMATIC OVERDRIVE (Ⓢ).

Here are some times you might choose DRIVE (D) instead of AUTOMATIC OVERDRIVE (Ⓢ):

- When driving on hilly, winding roads
- When going down a steep hill

SECOND (2): This position gives you more power but lower fuel economy. You can use SECOND (2) on hills. It can help control your speed as you go down steep mountain roads, but then you would also want to use your brakes off and on.

FIRST (1): This position gives you even more power (but lower fuel economy) than SECOND (2). You can use it on very steep hills, or in deep snow or mud. If the selector lever is put in FIRST (1), the transmission won't shift into first gear until the vehicle is going slowly enough.

NOTICE:

If your rear wheels can't rotate, don't try to drive. This might happen if you were stuck in very deep sand or mud or were up against a solid object. You could damage your transmission.

Also, if you stop when going uphill, don't hold your vehicle there with only the accelerator pedal. This could overheat and damage the transmission. Use your brakes or shift into PARK (P) to hold your vehicle in position on a hill.

Maximum engine speed is limited to protect driveline components from improper operation.

Manual Transmission

6-Speed

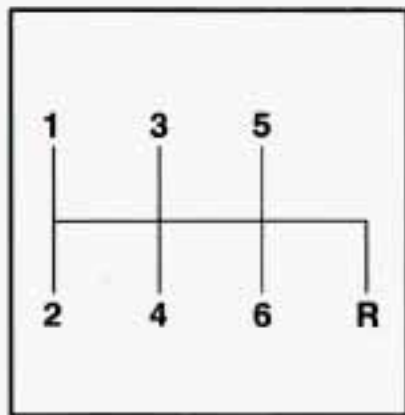

This is your shift pattern. Here's how to operate your transmission:

FIRST (1): Press the clutch pedal and shift into FIRST (1). Then slowly let up on the clutch pedal as you press the accelerator pedal.

You can shift into FIRST (1) when you're going less than 40 mph (64 km/h). If you've come to a complete stop and it's hard to shift into FIRST (1), put the shift lever in NEUTRAL (N) and let up on the clutch. Press the clutch pedal back down. Then shift into FIRST (1).

SECOND (2): Press the clutch pedal as you let up on the accelerator pedal and shift into SECOND (2). Then, slowly let up on the clutch pedal as you press the accelerator pedal.

THIRD (3), FOURTH (4), FIFTH (5) AND SIXTH (6): Shift into THIRD (3), FOURTH (4), FIFTH (5) and SIXTH (6) the same way you do for SECOND (2). Slowly let up on the clutch pedal as you press the accelerator pedal.

TO STOP: Let up on the accelerator pedal and press the brake pedal. Just before the vehicle stops, press the clutch pedal and the brake pedal, and shift to NEUTRAL (N).

NEUTRAL (N): Use this position when you start or idle your engine. Your shift lever is in NEUTRAL (N) when it is centered in the shift pattern, not in any other gear.

REVERSE (R): To back up, press down the clutch pedal and shift into REVERSE (R). Just apply pressure to get the lever past FIFTH (5) and SIXTH (6) into REVERSE (R). Let up on the clutch pedal slowly while pressing the accelerator pedal.

Shift Speeds (Manual Transmission)

This chart shows when to shift to the next higher gear for best fuel economy.

| Manual Transmission Recommended Shift Speeds in mph (km/h) | | | | | |
|--|--------------------------|------------|------------|------------|------------|
| Engine | Acceleration Shift Speed | | | | |
| | 1 to 2 | 2 to 3 | 3 to 4 | 4 to 5 | 5 to 6 |
| All Engines | 15 (24) | 25 (40) | 40 (64) | 45 (72) | 50 (80) |

If your engine speed drops below 900 rpm, or if the engine is not running smoothly, you should downshift to the next lower gear. You may have to downshift two or more gears to keep the engine running smoothly or for good performance.

NOTICE:

When you are shifting gears, don't move the gear shift lever around needlessly. This can damage parts of the transmission and may require costly repair. Shift directly into the next appropriate gear.

One to Four Light (Manual Transmission)

**ONE TO
FOUR**

When this light comes on, you can only shift from FIRST (1) to FOURTH (4) instead of FIRST (1) to SECOND (2). You must complete the shift into FOURTH (4) to deactivate this feature. This helps you get the best possible fuel economy.

After shifting to FOURTH (4), you may shift down to a lower gear if you prefer.

NOTICE:

Do not try to force the shift lever into SECOND (2) or THIRD (3) when the ONE TO FOUR light comes on. Do not try to re-engage FIRST (1) after starting to shift into FOURTH (4). You will damage your transmission. Shift only from FIRST (1) to FOURTH (4) when the light comes on.

This light will come on when:

- The engine coolant temperature is higher than 120°F (49°C).
- You are going 15 to 19 mph (24 to 31 km/h), and
- You are at 21 percent throttle or less.

Downshifting (Manual Transmission)

Do not downshift into the gear shown below at a speed greater than shown in the table:

| | |
|------------|--------------------|
| FIRST (1) | 44 mph (71 km/h) |
| SECOND (2) | 64 mph (103 km/h) |
| THIRD (3) | 90 mph (145 km/h) |
| FOURTH (4) | 116 mph (187 km/h) |



CAUTION:

If you skip more than one gear when you downshift, you could lose control of your vehicle. And you could injure yourself or others. Don't shift from SIXTH (6) to THIRD (3), FIFTH (5) to SECOND (2) or FOURTH (4) to FIRST (1).

NOTICE:

If you skip more than one gear when you downshift, or if you race the engine when you downshift, you can damage the clutch or transmission.

The six-speed transmission has a spring that centers the shift lever near THIRD (3) and FOURTH (4). This spring helps you know which gear you are in when you are shifting. Be careful when shifting from FIRST (1) to SECOND (2) or downshifting from SIXTH (6) to FIFTH (5). The springs will try to pull the gear shift lever toward FOURTH (4) and THIRD (3). Make sure you move the lever into SECOND (2) or FIFTH (5). If you let the lever move in the direction of the pulling, you may end up shifting from FIRST (1) to FOURTH (4) or from SIXTH (6) to THIRD (3).

Ride Control (Option)

You may have a ride control system on your Corvette called Real Time Damping (RTD). The system provides the following performance benefits:

- Reduced impact harshness
- Improved road isolation
- Improved high-speed stability
- Improved handling response

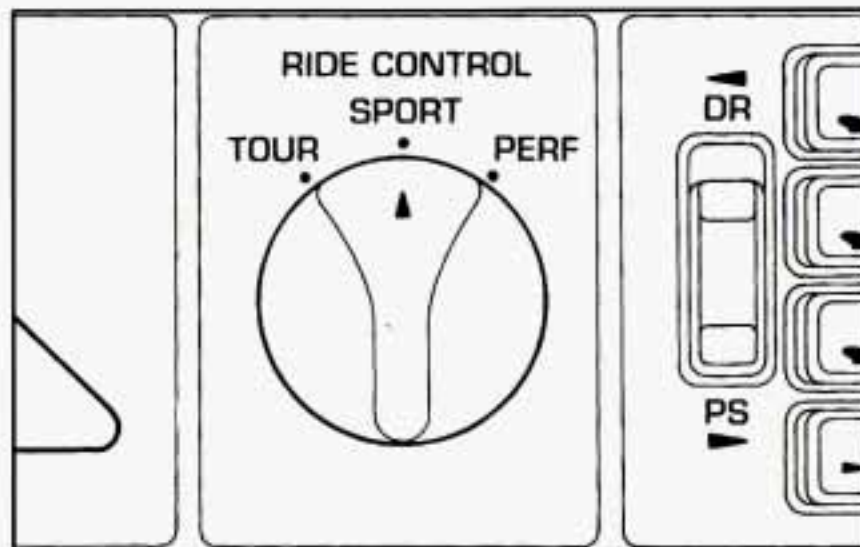

This knob is on the center console. Turn it to select the ride control of your choice.

TOUR: Use for city and highway driving. Provides a smooth, soft ride.

SPORT: Use where road conditions or personal preference demand more control. Provides more “feel,” or response to the road conditions.

PERF: Use for performance driving. Provides a tight, firm ride and precise response to road conditions.

You can select a setting at any time. Based on road conditions and your vehicle speed, the system automatically adjusts to provide the best ride and handling. Select a new setting whenever driving conditions change.

The SERVICE RIDE CONTROL light monitors the system. Refer to “Service Ride Control Light” in the Index.

Limited-Slip Rear Axle

Your rear axle can give you additional traction on snow, mud, ice, sand or gravel. It works like a standard axle most of the time, but when one of the rear wheels has no traction and the other does, the limited-slip feature will allow the wheel with traction to move the vehicle.

Parking Brake

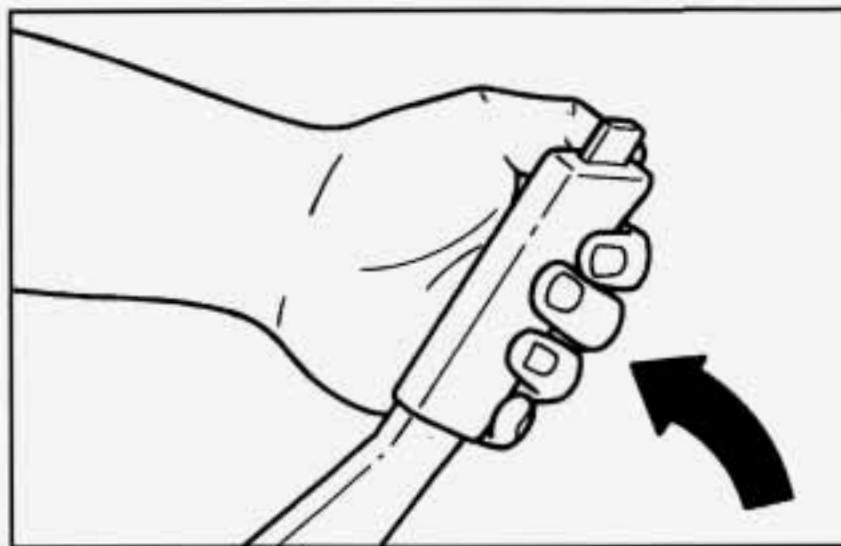

To set the parking brake, hold the brake pedal down. Pull the parking brake lever up, then move it back down. This sets your parking brake, even though the lever is down. If the ignition is on, the parking brake indicator light will come on.

Shifting Into PARK (P) (Automatic Transmission Models Only)

CAUTION:

It can be dangerous to get out of your vehicle if the shift lever is not fully in PARK (P) with the parking brake firmly set. Your vehicle can roll. If you have left the engine running, the vehicle can move suddenly. You or others could be injured. To be sure your vehicle won't move, even when you're on fairly level ground, use the steps that follow.

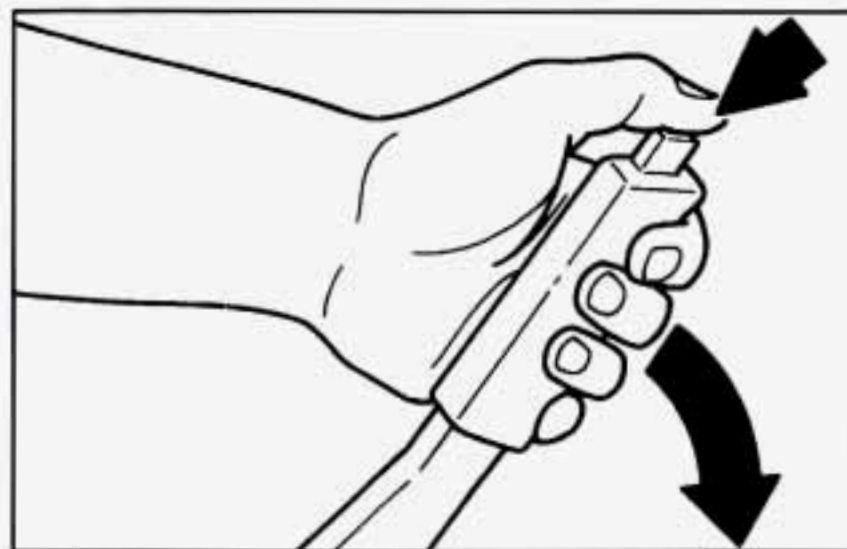

To release the parking brake, hold the brake pedal down. Pull the parking brake lever up until you can push in the release button. Hold the release button in as you move the brake lever all the way down.

NOTICE:

Driving with the parking brake on can cause your rear brakes to overheat. You may have to replace them, and you could also damage other parts of your vehicle.



Leaving Your Vehicle With the Engine Running (Automatic Transmission Models Only)

CAUTION:

It can be dangerous to leave your vehicle with the engine running. Your vehicle could move suddenly if the shift lever is not fully in PARK (P) with the parking brake firmly set. And, if you leave the vehicle with the engine running, it could overheat and even catch fire. You or others could be injured. Don't leave your vehicle with the engine running unless you have to.

1. Hold the brake pedal down with your right foot and set the parking brake.
2. Move the shift lever into the PARK (P) position by holding in the button on the lever and pushing the lever all the way toward the front of your vehicle.
3. Move the ignition key to LOCK.
4. Remove the key and take it with you. If you can remove the key from your ignition, your vehicle is in PARK (P).

Torque Lock (Automatic Transmission)

If you are parking on a hill and you don't shift your transmission into PARK (P) properly, the weight of the vehicle may put too much force on the parking pawl in the transmission. You may find it difficult to pull the shift lever out of PARK (P). This is called "torque lock." To prevent torque lock, set the parking brake and then shift into PARK (P) properly before you leave the driver's seat. To find out how, see "Shifting Into PARK (P)" in the Index.

When you are ready to drive, move the shift lever out of PARK (P) *before* you release the parking brake.

If torque lock does occur, you may need to have another vehicle push yours a little uphill to take some of the pressure from the transmission, so you can pull the shift lever out of PARK (P).

Shifting Out of PARK (P) (Automatic Transmission)

Your Corvette has a brake-transmission shift interlock. You have to fully apply your regular brake before you can shift from PARK (P) when the ignition is in the RUN position. See "Automatic Transmission Operation" in the Index.

If you cannot shift out of PARK (P), ease pressure on the shift lever -- push the shift lever all the way into PARK (P) and release the shift lever button as you maintain brake application. Then press the shift lever button and move the shift lever into the gear you wish.

If you ever hold the brake pedal down but still can't shift out of PARK (P), try this:

1. Turn the key to the OFF position.
2. Apply and hold the brake until the end of Step 4.
3. Shift to NEUTRAL (N).
4. Start the engine and then shift to the drive gear you want.
5. Have the vehicle fixed as soon as you can.

Parking Your Vehicle (Manual Transmission)

Before you get out of your vehicle, put your manual transmission in REVERSE (R) and firmly apply the parking brake.

Parking Over Things That Burn



CAUTION:

Things that can burn could touch hot exhaust parts under your vehicle and ignite. Don't park over papers, leaves, dry grass or other things that can burn.

Engine Exhaust

CAUTION:

Engine exhaust can kill. It contains the gas carbon monoxide (CO), which you can't see or smell. It can cause unconsciousness and death.

You might have exhaust coming in if:

- Your exhaust system sounds strange or different.
- Your vehicle gets rusty underneath.
- Your vehicle was damaged in a collision.
- Your vehicle was damaged when driving over high points on the road or over road debris.
- Repairs weren't done correctly.
- Your vehicle or exhaust system had been modified improperly.

If you ever suspect exhaust is coming into your vehicle:

- Drive it only with all the windows down to blow out any CO; and
- Have your vehicle fixed immediately.

Running Your Engine While You're Parked (Automatic Transmission)

It's better not to park with the engine running. But if you ever have to, here are some things to know.

CAUTION:

Idling the engine with the air system control off could allow dangerous exhaust into your vehicle (see the earlier Caution under "Engine Exhaust").

Also, idling in a closed-in place can let deadly carbon monoxide (CO) into your vehicle even if the fan switch is at the highest setting. One place this can happen is a garage. Exhaust -- with CO -- can come in easily. NEVER park in a garage with the engine running.

Another closed-in place can be a blizzard. (See "Blizzard" in the Index.)

CAUTION:

It can be dangerous to get out of your vehicle if the shift lever is not fully in PARK (P) with the parking brake firmly set. Your vehicle can roll. Don't leave your vehicle when the engine is running unless you have to. If you've left the engine running, the vehicle can move suddenly. You or others could be injured. To be sure your vehicle won't move, even when you're on fairly level ground, always set your parking brake and move the shift lever to PARK (P).

Follow the proper steps to be sure your vehicle won't move. See "Shifting Into PARK (P)" in the Index.

Windows

Power Windows

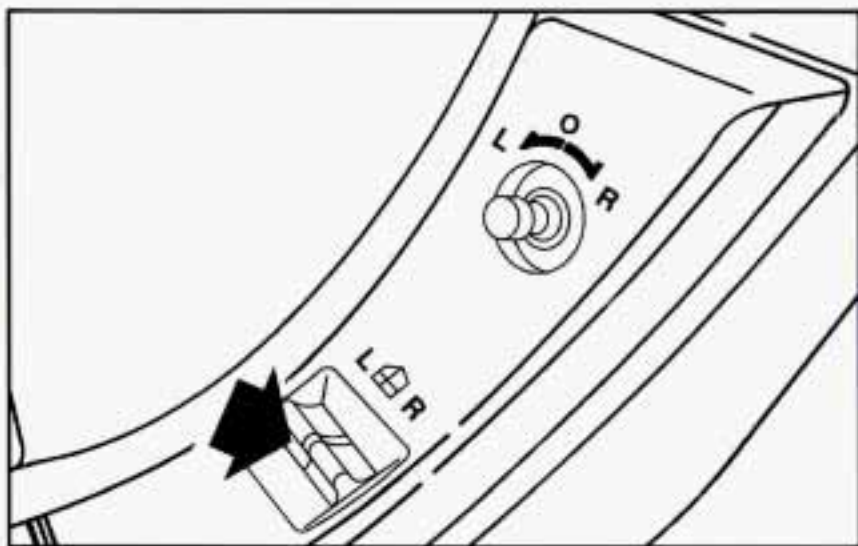

With power windows, switches on the door control each window when the ignition is on or when DAB is present. (See “Delayed Accessory Bus” in the Index.)

Express-Down Window

The switch for the driver’s window has an express-down feature. Press the switch for at least one third of a second, and the window will lower completely. To stop express-down, press the switch again.

You can also open this window any amount by quickly pressing and releasing the switch.

Horn

To sound the horn, press either horn symbol on your steering wheel.

Tilt Wheel



A tilt wheel allows you to adjust the steering wheel before you drive.

You can also raise it to the highest level to give your legs more room when you exit and enter the vehicle.

To tilt the wheel, hold the steering wheel and pull the lever toward you. Move the steering wheel to a comfortable level, then release the lever to lock the wheel in place.

Turn Signal/Multifunction Lever

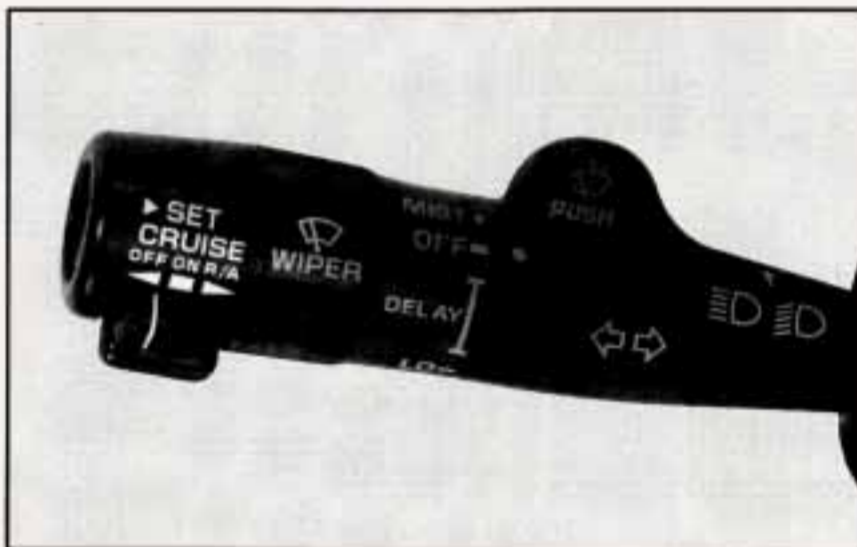

The multifunction lever on the left side of the steering column includes your:

- Turn Signal and Lane Change Indicator
- Headlamp High/Low Beam Changer
- Windshield Wipers
- Windshield Washer
- Cruise Control

Turn and Lane Change Signals

The turn signal has two upward (for right) and two downward (for left) positions. These positions allow you to signal a turn or a lane change.

To signal a turn, move the multifunction lever all the way up or down. When the turn is finished, the lever will return automatically.

A chime will remind you if you leave your turn signal on for more than 1 mile (1.6 km) of driving.

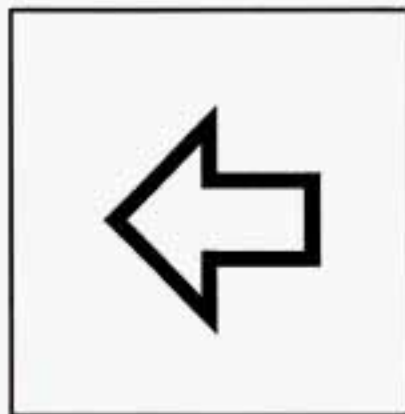

An arrow on the instrument panel will flash in the direction of the turn or lane change.

To signal a lane change, just raise or lower the lever until the arrow starts to flash. Hold it there until you complete your lane change. The lever will return by itself when you release it.

As you signal a turn or a lane change, if the arrows don't flash but just stay on, a signal bulb may be burned out and other drivers won't see your turn signal.

If a bulb is burned out, replace it to help avoid an accident. If the arrows don't go on at all when you signal a turn, check for burned-out bulbs and check the fuse (see "Fuses and Circuit Breakers" in the Index).

Headlamp High/Low Beam Changer

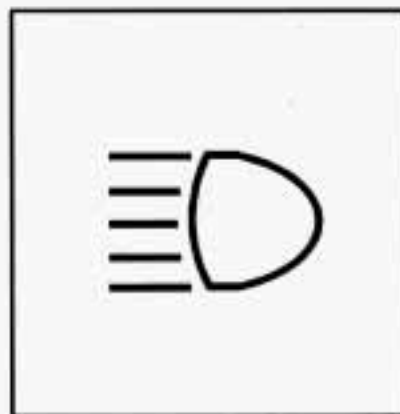

To change the headlamps from low beam to high or high to low, pull the turn signal lever all the way toward you. Then release it. When the high beams are on, this light on the instrument panel also will be on.

Windshield Wipers

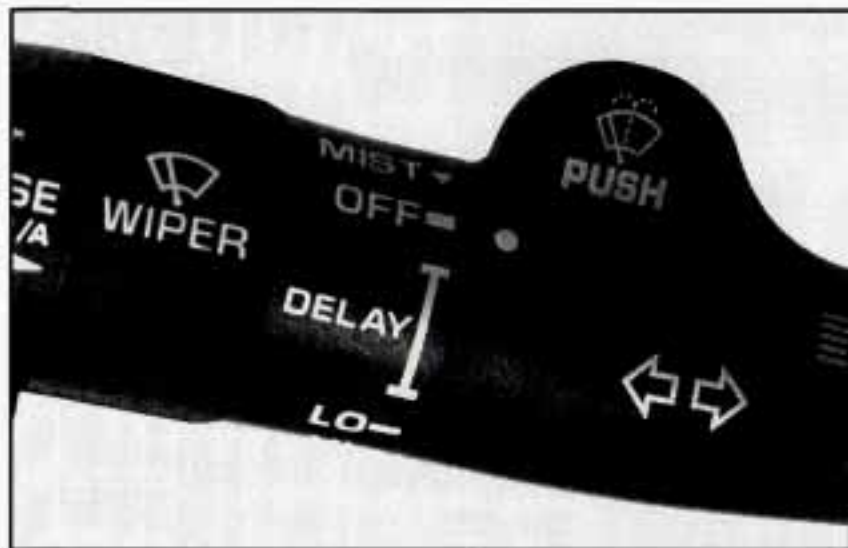

You control the windshield wipers by turning the band with the wiper symbol on it.

For a single wiping cycle, turn the band to MIST. Hold it there until the wipers start, then let go. The wipers will stop after one cycle. If you want more cycles, hold the band on MIST longer.

You can set the wiper speed for a long or short delay between wipes. This can be very useful in light rain or snow. Turn the band to choose the delay time. The closer to LO, the shorter the delay.

For steady wiping at low speed, turn the band away from you to the LO position. For high speed wiping, turn the band further, to HI. To stop the wipers, move the band to OFF.

Be sure to clear ice and snow from the wiper blades before using them. If they're frozen to the windshield, carefully loosen or thaw them. If your blades do become damaged, get new blades or blade inserts.

Heavy snow or ice can overload your wipers. A circuit breaker will stop them until the motor cools. Clear away snow or ice to prevent an overload.

Windshield Washer

At the top of the turn signal lever there's a paddle with the word PUSH on it. To spray washer fluid on the windshield, just push the paddle for less than a second. If you hold the paddle for more than a second, the washer will spray until you release the paddle. The wipers will clear the window and stop or return to the previous setting.

CAUTION:

In freezing weather, don't use your washer until the windshield is warmed. Otherwise the washer fluid can form ice on the windshield, blocking your vision.

For information on the correct washer fluid mixture to use, see "Windshield Washer Fluid" in the Index.

Cruise Control



With cruise control, you can maintain a speed of about 25 mph (40 km/h) or more without keeping your foot on the accelerator. This can really help on long trips. Cruise control does not work at speeds below about 25 mph (40 km/h).

When you apply your brakes or push the clutch pedal, the cruise control shuts off.

CAUTION:

- Cruise control can be dangerous where you can't drive safely at a steady speed. So, don't use your cruise control on winding roads or in heavy traffic.
- Cruise control can be dangerous on slippery roads. On such roads, fast changes in tire traction can cause needless wheel spinning, and you could lose control. Don't use cruise control on slippery roads.

If your vehicle is in cruise control when the ASR system begins to limit wheel spin, the cruise control will automatically disengage. (See "ASR System" in the Index.) When road conditions allow you to safely use it again, you may turn the cruise control back on.

Setting Cruise Control

CAUTION:

If you leave your cruise control switch on when you're not using cruise, you might hit a button and go into cruise when you don't want to. You could be startled and even lose control. Keep the cruise control switch OFF until you want to use it.

1. Turn the cruise control switch to ON.
2. Get up to the speed you want.



3. Push in the SET button at the end of the lever and release it.

4. Take your foot off the accelerator pedal.

Resuming a Set Speed

Suppose you set your cruise control at a desired speed and then you apply the brake or clutch pedal. This, of course, shuts off the cruise control. But you don't need to reset it.



Once you're going about 25 mph (40 km/h) or more, you can move the cruise control switch to R/A (Resume/Accelerate) for about half a second.

You'll go right back up to your chosen speed and stay there.

Increasing Speed While Using Cruise Control

There are two ways to go to a higher speed:

- Use the accelerator pedal to get to the higher speed. Push the button at the end of the lever, then release the button and the accelerator pedal. You'll now cruise at the higher speed.
- Move the cruise switch to R/A. Hold it there until you get up to the speed you want, then release the switch. To increase your speed in very small amounts, move the switch to R/A for less than half a second, then release it. Each time you do this, your vehicle will go about 1 mph (1.6 km/h) faster.

Reducing Speed While Using Cruise Control

There are two ways to reduce your speed while using cruise control:

- Push in the button at the end of the lever until you reach the lower speed you want, then release it.
- To slow down in very small amounts, push the button for less than half a second. Each time you do this, you'll go 1 mph (1.6 km/h) slower.

Passing Another Vehicle While Using Cruise Control

Use the accelerator pedal to increase your speed. When you take your foot off the pedal, your vehicle will slow down to the cruise control speed you set earlier.

Using Cruise Control on Hills

How well your cruise control will work on hills depends upon your speed, load and the steepness of the hills. When going up steep hills, you may have to step on the accelerator pedal to maintain your speed. When going downhill, you may have to brake or shift to a lower gear to keep your speed down. Of course, applying the brake takes you out of cruise control. Many drivers find this to be too much trouble and don't use cruise control on steep hills.

Getting Out of Cruise Control

There are several ways to turn off the cruise control:

- Step lightly on the brake pedal or push the clutch pedal, if you have a manual transmission; or
- Move the cruise switch to OFF.

Erasing Speed Memory

When you turn off the cruise control or the ignition, your cruise control set speed memory is erased.

Lamps

Headlamps

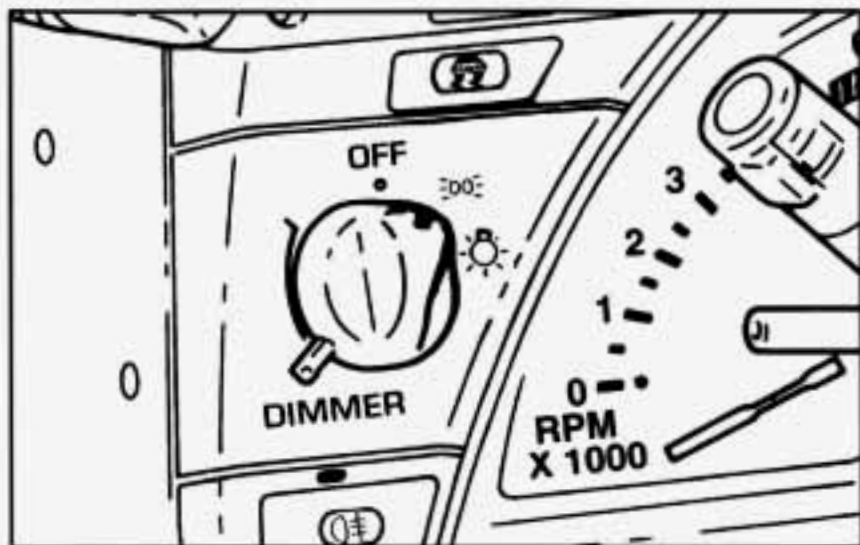

The headlamp knob controls these lamps:

- Headlamps
- Taillamps
- Parking lamps
- Sidemarker lamps

 Turn the knob to this symbol to turn on your headlamps and other operating lamps.

 Turn the knob to this symbol to turn on your parking and other operating lamps without your headlamps.

Turn the knob to OFF to turn off the lamps.

Your digital display will dim at dusk to remind you to turn on your headlamps.

To read your odometer and fuel level with the ignition off, turn on your parking lamps.

Headlamp Doors

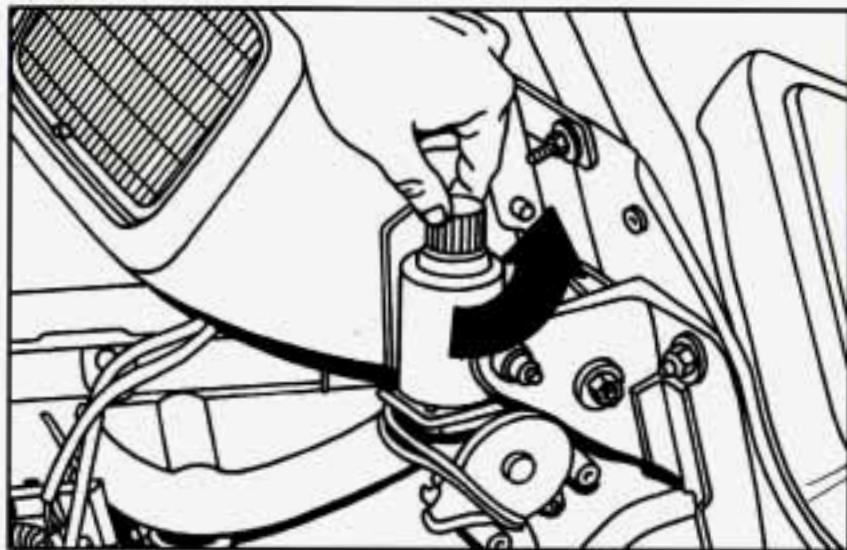

The headlamp doors are designed to open when you turn the headlamps on, and close when you turn the headlamps and parking lamps off. If you turn the headlamps on, then turn the headlamp switch back to the parking lamps setting, the headlamp doors will stay open.

You can open the doors manually using the knob next to the headlamp assembly. Turn the knob counterclockwise until the doors are open.

The headlamp doors should be open when driving in icy or snowy conditions to prevent the doors from freezing closed and when washing the vehicle to help clean the headlamps.

Lamps On Reminder

If you turn the ignition off and leave the headlamps or parking lamps on, you will hear a chime.

Daytime Running Lamps (Canada Only)

Daytime Running Lamps (DRL) can make it easier for others to see the front of your vehicle during the day. DRL can be helpful in many different driving conditions, but they can be especially helpful in the short periods after dawn and before sunset.

A light sensor on top of the instrument panel makes the DRL work, so be sure it isn't covered.

The DRL system will make your front turn signal lamps come on when:

- The ignition is on,
- The headlamp switch is off, and
- The parking brake is released.

When the DRL are on, only your front turn signal lamps will be on. The taillamps, sidemarker and other lamps won't be on. Your instrument panel won't be lit up either.

When it's dark enough outside, your front turn signal lamps will go out and your headlamps will come on. The other lamps that come on with your headlamps will also come on.

When it's bright enough outside, the regular lamps will go off, and your front turn signal lamps come on.

As with any vehicle, you should turn on the regular headlamp system when you need it.

Fog Lamps



Use your fog lamps for better vision in foggy or misty conditions. Your parking lamps or low-beam headlamps must be on or your fog lamps won't work.

To turn the fog lamps on, push the button. Push the button again to turn the fog lamps off. A light above the button will come on when the fog lamps are on.

Interior Lamps

Instrument Panel Brightness Control

The DIMMER switch controls the brightness of your instrument panel lights when your headlamps or parking lamps are on. Move the switch up or down to brighten or dim the lamps. If you turn the switch all the way up, your courtesy, reading, map and cargo area lamps will come on. Be sure to turn off the lamps when you leave your vehicle.

Courtesy Lamps

When any door or the hatch is opened, the interior lamps will go on (unless it's bright outside). The lamps will stay on for about 30 seconds or until you turn on the ignition.

Door Flood Lamps

There are flood lamps located above the door handle on each door which come on with the headlamps or parking lamps.

Front Map Lamps

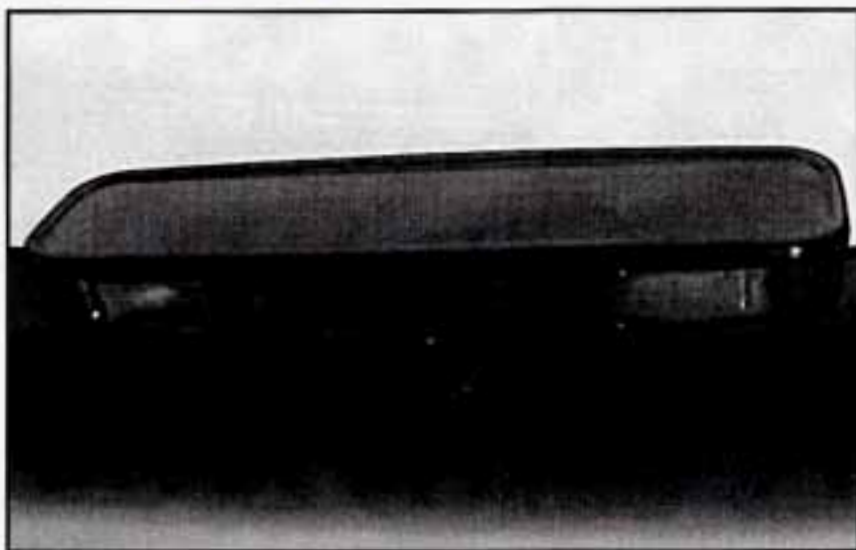

Your inside rearview mirror includes two map lamps. The lamps will go on when a door is opened. When the doors are closed and the ignition is on, press the switch to turn on the lamps.

There is also an interior console flood lamp located underneath the rearview mirror which comes on with the headlamps or parking lamps.

Mirrors

Inside Day/Night Rearview Mirror

An inside rearview mirror is attached above your windshield. The mirror has pivots so that you can adjust it.

You can adjust the mirror for day or night driving. Pull the tab for night driving to reduce glare. Push the tab for daytime driving.

Power Remote Control Mirrors

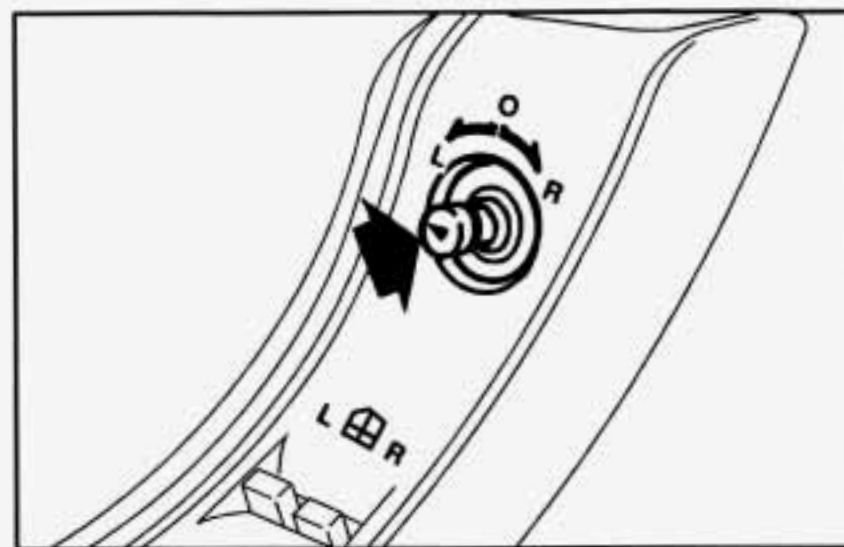

The electric mirror control is on the driver's door. To adjust either mirror, turn the switch to LEFT (L) or RIGHT (R). Then use the control to adjust the mirror. When you are done adjusting the mirrors, move the control back to the center to avoid accidental adjustment.

Convex Outside Mirror

Your passenger's side mirror is convex. A convex mirror's surface is curved so you can see more from the driver's seat.

CAUTION:

A convex mirror can make things (like other vehicles) look farther away than they really are. If you cut too sharply into the right lane, you could hit a vehicle on your right. Check your inside mirror or glance over your shoulder before changing lanes.

Storage Compartments

Door Storage

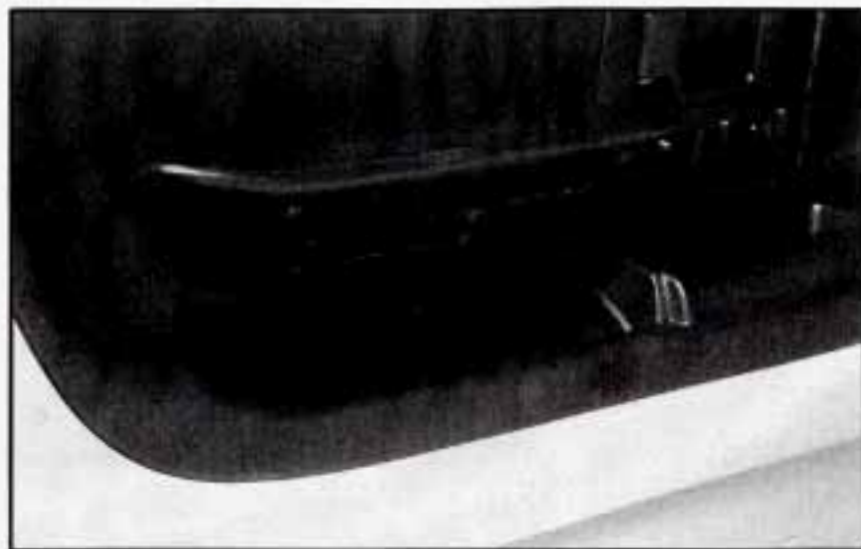

Each door has a storage compartment below the armrest which can be accessed by lifting up on the armrest.

Center Console



To use this storage area, push the button on the front end of the console and lift.

You can use the door key to lock and unlock the console. Don't leave the key in the lock or it could be damaged when the driver sits down.

Your roof panel or hardtop wrench is stored inside the console.

Security Shade (Coupe)

The security shade can provide hidden storage in the rear area of your vehicle.

Using the Security Shade

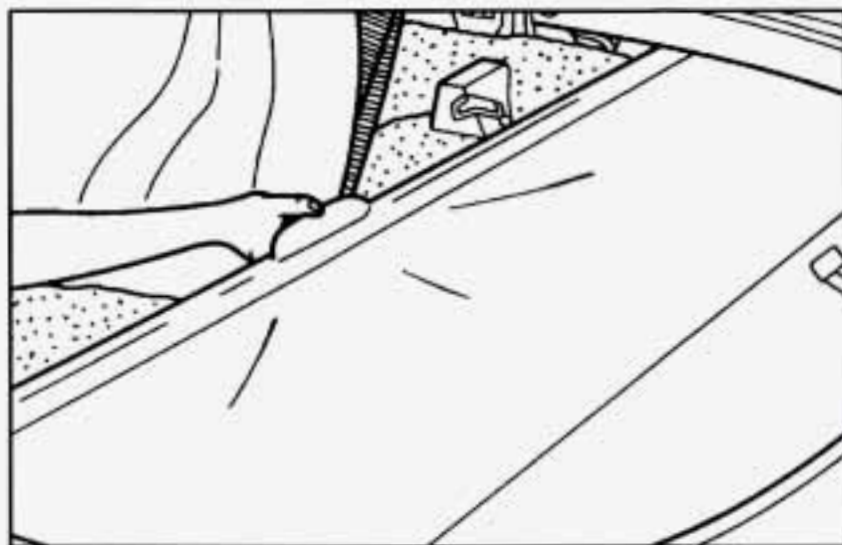

1. Pull the security shade by the center handle.

Rear Storage

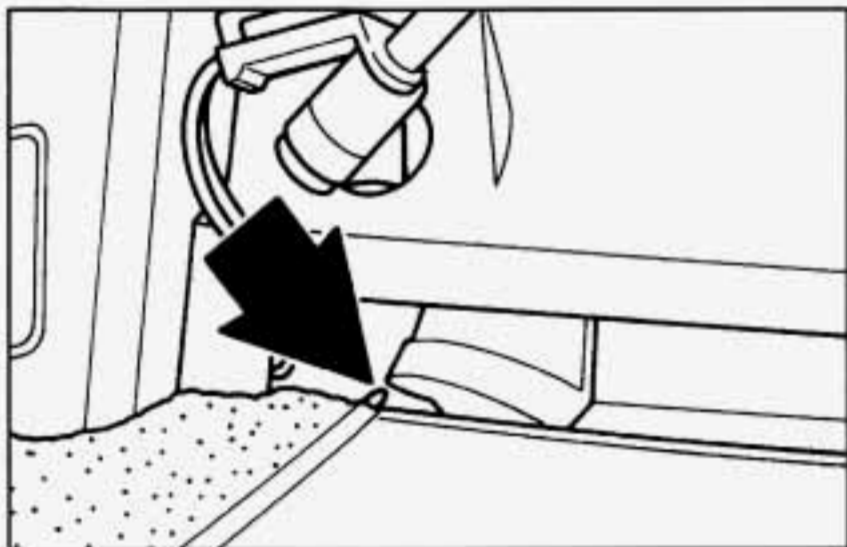

2. Put the ends of the shade into the slots behind the seats.

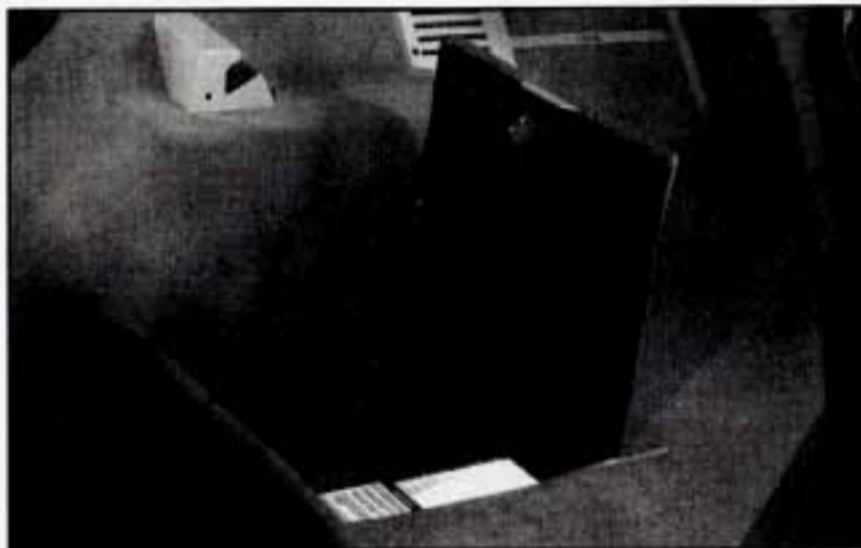

This compartment is in the floor behind the passenger's seat. To use it, push the button and lift the lid at the same time. Use the door key to lock it.

The top tray can be removed. The jack (if equipped), wheel lock key and wheel nut socket are stored below the tray.

NOTICE:

Your Corvette's radio receiver is in the rear storage compartment. To help avoid damage to the receiver:

- Securely store the jack (if equipped) in the foam container after use.
- Store any other objects under the storage tray carefully.
- Do not store items such as liquids or sharp objects that could puncture or cut the radio receiver or wiring.

Also, to reduce the potential for radio receiver interference, do not install any other electronic module under the storage tray.

Ashtray and Cigarette Lighter

To use the ashtray, push on the right side of the door next to the shift lever. To remove it, lift up on the snuffer.

NOTICE:

Don't put papers and other things that burn into your ashtray. If you do, cigarettes or other smoking materials could set them on fire, causing damage.

You can remove the ashtray and use the space as a second cupholder. When you put the ashtray back, first put the ashtray into the rubber isolator, then be sure to put the ashtray and isolator into the forward opening.

NOTICE:

Loose objects (such as paper clips) can lodge behind and beneath the ashtray lid and prevent movement of the lid. Avoid putting small loose objects near the ashtray.

To use the lighter, push it in all the way and let go. When it's ready, it will pop back by itself.

NOTICE:

Don't hold a cigarette lighter in with your hand while it is heating. If you do, it won't be able to back away from the heating element when it's ready. That can make it overheat, damaging the lighter and the heating element.

Sun Visors

To block out glare, you can swing down the visors. You can also swing them to the side.

With the hardtop roof removed or the convertible top down, you can flip the visors straight up to help reduce wind turbulence.

Visor Vanity Mirror

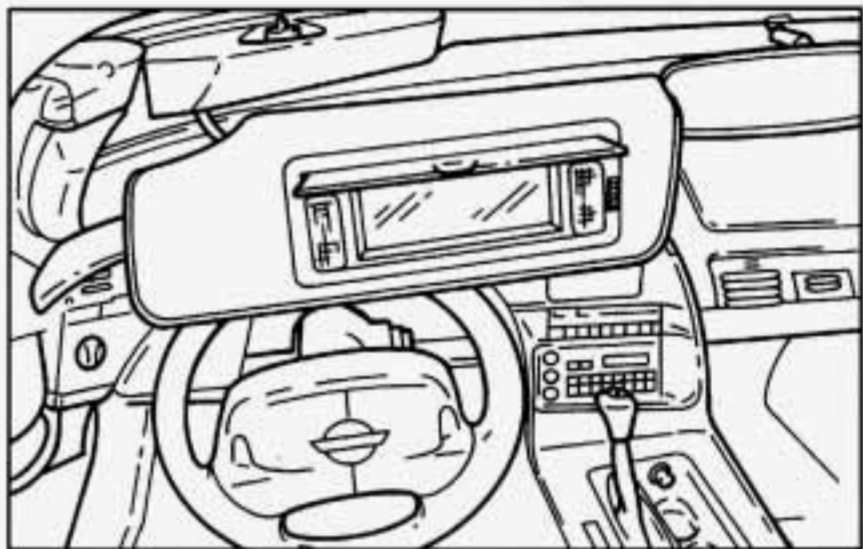

Pull down the sun visor and lift the cover to expose the vanity mirror. When the ignition is on, slide the switch next to the mirror up to turn the lamps on. Be sure to turn the lamps off before closing the cover.

Accessory Plug

This plug is under the trim panel in the front part of the center console. The plug can be used to connect electrical equipment such as a cellular phone or CB radio. Be sure to follow the installation instructions included with the equipment.

To use the accessory plug:

1. Open the center console and carefully pull the carpet away from the coinholder to uncover the screws on either side.
2. Remove the screws. (See the arrows in the following illustration.)

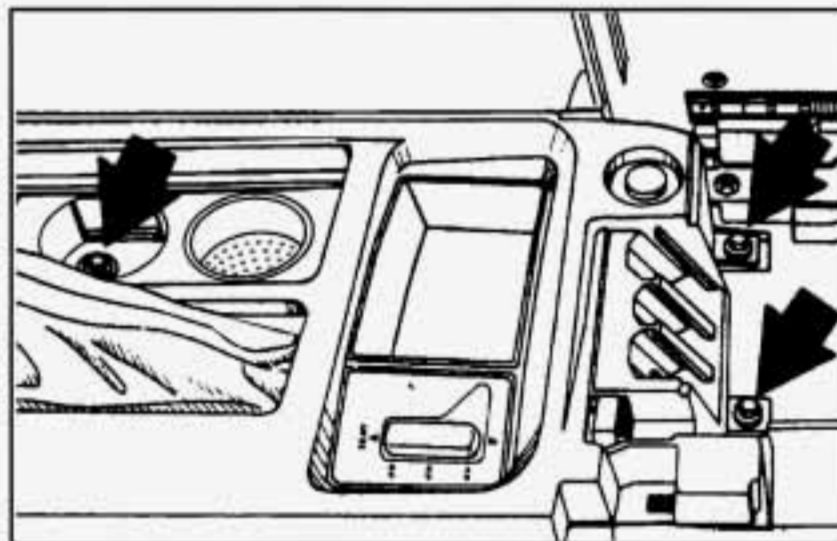

3. Open the ashtray door, remove the ashtray and the rubber insert from the forward location, and remove the screw inside the cupholder.
4. Remove the four screws that attach the console door.
5. Remove the console door.
6. Remove the trim plate by pulling up and back.
7. Disconnect the plug by pulling forward on the plastic locking tab and pull the plug into the console.

The plug has three separate wires:

- The orange wire connects to the battery.

- The pink wire connects to the ignition. Power is only available in the RUN position.
- The black wire connects to the ground.

NOTICE:

When using the accessory plug:

- **Don't splice wires directly into the accessory plug wire. If done incorrectly, splicing might cause damage to your electrical system.**
- **The maximum load of any electrical equipment should not exceed 10 amps.**
- **Be sure to turn off any electrical equipment when not in use. Leaving electrical equipment on for extended periods can drain your battery.**
- **Do not use this plug if the electrical equipment requires frequent connecting and disconnecting. This may cause excessive wear on the accessory plug and damage your electrical system.**

After you've installed the electrical equipment, put the trim panel and console lid back in place and install the screws.

Roof Panel (Coupe)

Until you are sure you can remove the panel alone, have someone help you.

Removing the Roof Panel

CAUTION:

Don't try to remove the roof panel while the vehicle is moving. Trying to remove the roof panel while the vehicle is moving could cause an accident. The panel could fall into the vehicle and cause you to lose control, or it could fly off and strike another vehicle. You or others could be injured. Remove the roof panel only when the vehicle is parked.

1. Park on a level surface, set the parking brake firmly and shift an automatic transmission into PARK (P). Shift a manual transmission into REVERSE (R). Lower both windows, turn the ignition key to LOCK and move both sunshades to the side.

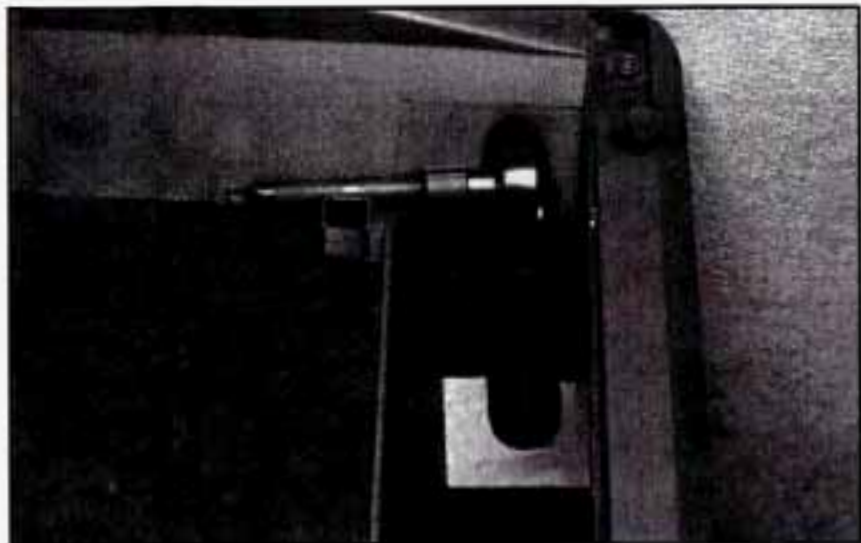

2. Remove the ratchet from the console.

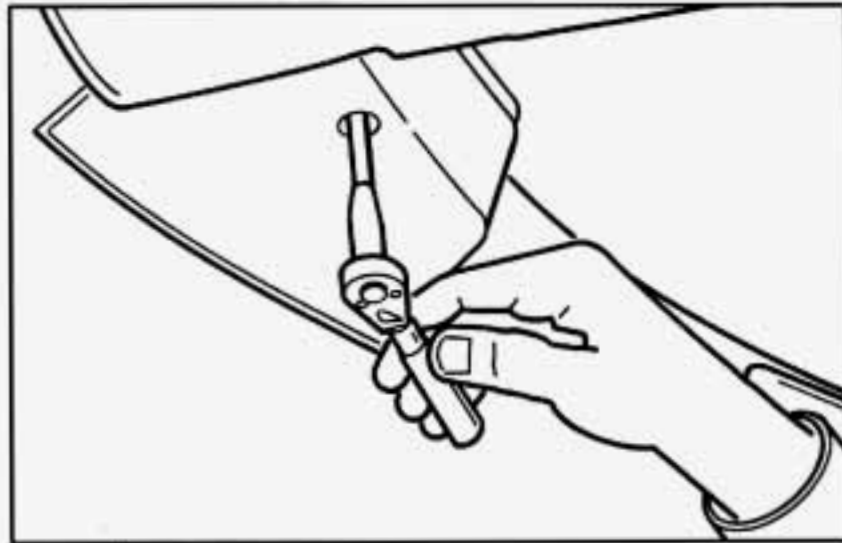

3. Use the ratchet to loosen the front bolts. Don't remove them. They'll stay in place when loose.

Storing the Roof Panel



CAUTION:

If the roof panel is not stored properly, it could be thrown about the vehicle in a crash or sudden maneuver. People in the vehicle could be injured. Whenever you store the roof panel in the vehicle, always be sure that it is stored securely in the rear area using the storage brackets and latch pin.

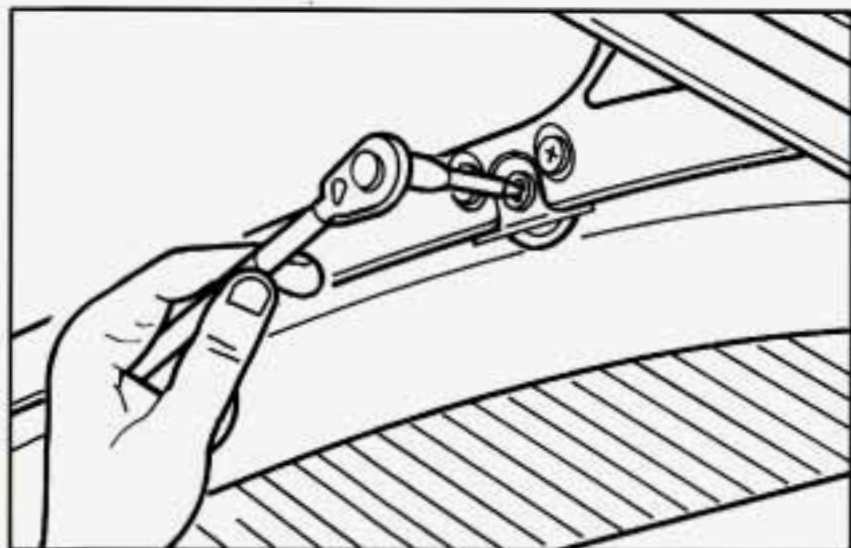

4. The two rear bolts are on the roof, one above each seat. You'll see three bolts on each side. Loosen the middle one. (The ratchet won't work for the other two.) The bolts will stay in the roof panel.
5. Stand on one side of the vehicle and have your helper stand on the other side. Together, lift the front of the panel up. Then move forward and lift the panel off the vehicle.

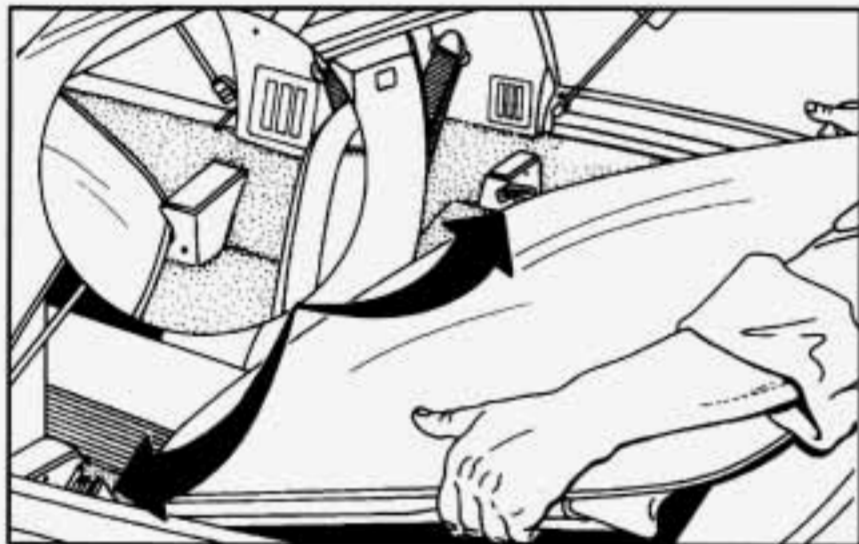

1. Open the rear hatch and look for the two brackets in the rear area. The brackets are below the courtesy lamps.

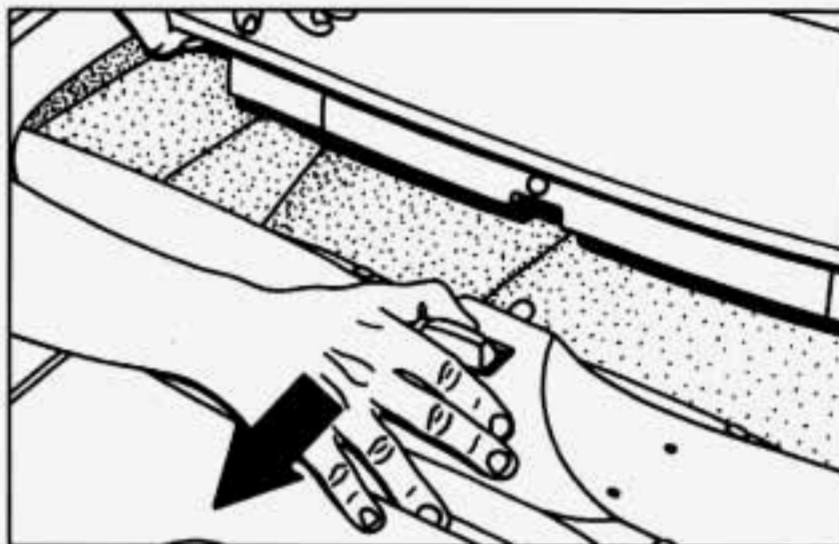

2. Store the roof panel with its top up and its rear pointing forward. Slide the rear corners of the roof panel into the brackets and push forward.

NOTICE:

Don't lift the front edge of the roof panel higher than 8 inches (200 mm) when the corners are in the brackets. If you do, you could damage the roof panel.

3. Lower the front of the roof panel, centering it over the latch pin.
4. Pull the release toward you and press down on the roof panel.
5. Push the release forward until it latches.
6. Gently lift up on the roof panel to be sure it is locked in place.

Installing the Roof Panel



CAUTION:

An improperly attached roof panel may fall into or fly off the vehicle. You or others could be injured. After installing the roof panel, always check that it is firmly attached by pushing up on the underside of the panel near the bolts. Check now and then to be sure the roof panel is firmly in place.

1. Park on a level surface, set the parking brake firmly and shift an automatic transmission into PARK (P). Shift a manual transmission into REVERSE (R). Lower both windows, turn the ignition key to LOCK and move both sunshades to the side.
2. If the roof panel is stored in the rear area, remove it by reversing the steps described previously under "Storing the Roof Panel."

3. Lower the roof panel onto the vehicle, rear edge first, and place the rear guide pins into the holes in the roof opening.
4. Lower the front of the roof panel, and align the front guide pins.
5. Tighten the rear bolts part way.

NOTICE:

If you tighten bolts that are improperly started, the threads can become stripped. Be sure all bolts are properly started before you tighten them.

6. Use the ratchet to start the front bolts. If the bolts are hard to start, tighten the rear bolts some more. Holding down the panel on the outside will also help.
7. Fully tighten the rear bolts, then the front bolts.

If you hear a popping noise when you drive, the bolts may not be tight enough. Be sure to tighten them securely.

Convertible Top (Option)

The following procedures explain the proper operation of your convertible top.

Lowering Your Convertible Top

NOTICE:

Don't leave your convertible out with the top down for any long periods of time. The sun and the rain can damage your seat material and other things inside your vehicle.

1. Park on a level surface, set the parking brake firmly and shift an automatic transmission into PARK (P). Shift a manual transmission into REVERSE (R). Lower both windows and sunshades and turn the ignition key to LOCK.

NOTICE:

Before lowering the convertible top into the storage area, be sure there are no objects in the way of the folded, stored top. The weight of a stored top on items in the storage area may cause the convertible top back glass to break.

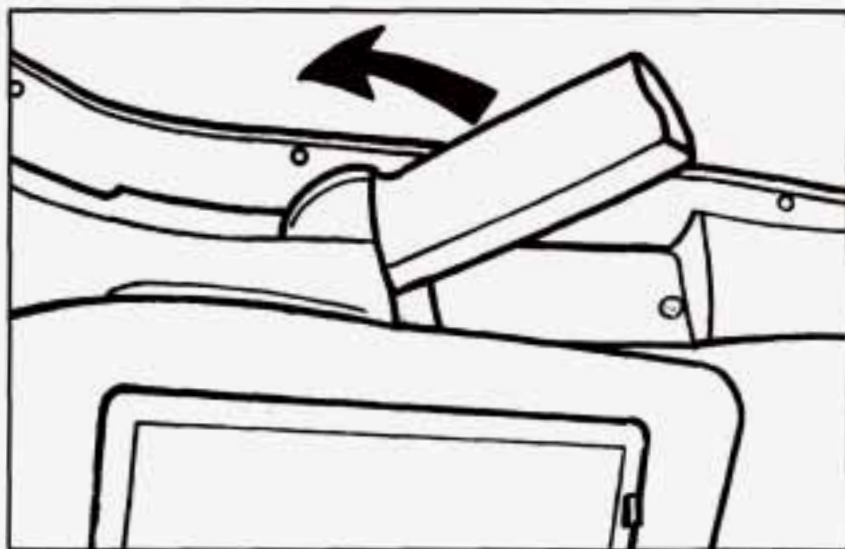

2. Unlock the front of the convertible top by turning the latch handles outward. Then lift the top off the windshield slightly.

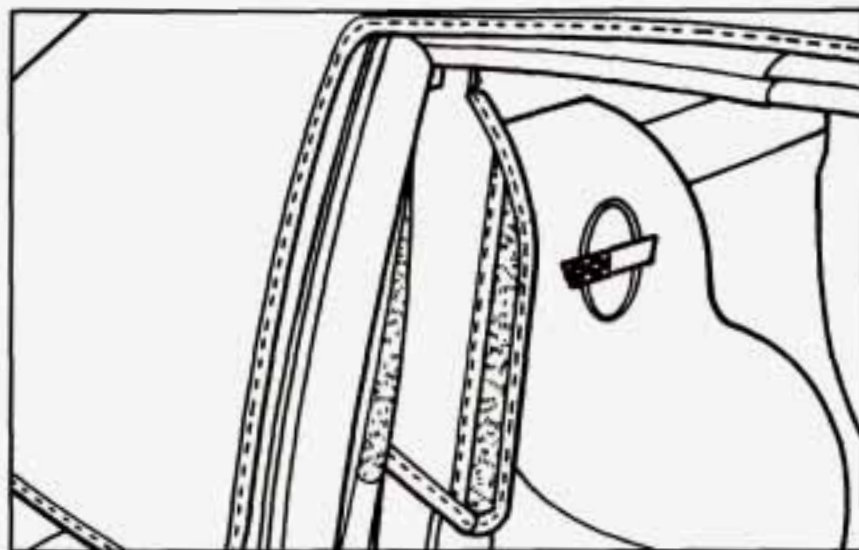

3. Unfasten the strips at the rear of each window opening.

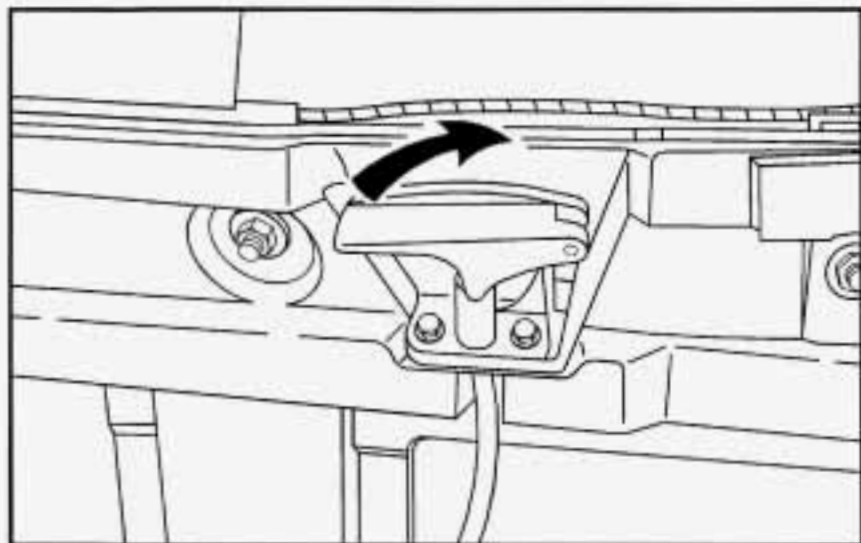

4. Tilt the driver's seatback forward. The convertible top release handle is behind the driver's seat, beneath the storage compartment lid. Pull the inside edge of the handle forward.



5. From the driver's side, lift and hold the rear of the top with your left hand. With your right hand, press the storage compartment lid release button behind the driver's seat on the lid (the release switch in the center console will also work). Raise the lid.

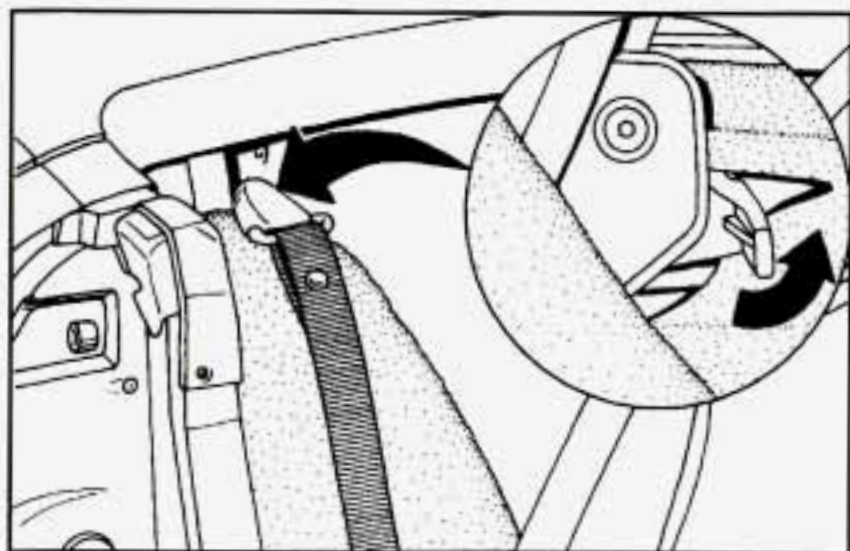

6. If your Corvette has lost power (dead battery, for example), you can still open the storage compartment using the manual release handles. The handles are near the sidewall, behind the safety belt anchors on each side of your vehicle. Move the handles toward the rear of the vehicle and upward.

NOTICE:

Do not leave the convertible top on the closed lid when lowering the top. This may result in paint damage.

7. Lower the rear of the top. Then lift the front with a slow, smooth motion. Fold the top into the storage compartment, making sure the fabric is folded between bows.

NOTICE:

Do not lift the rear of the convertible top when lowering the top into the storage compartment or damage to the top may occur.

8. After the top is completely folded into the compartment, turn the latch handles toward the center of the vehicle. Close the storage compartment lid by pushing the front edge down on each side. Try to lift the lid to make sure it's latched.

NOTICE:

When closing the storage compartment lid, make sure the latch handles are turned back toward the center of the vehicle. If they aren't, you may damage the paint on the lid inner panel.

Raising Your Convertible Top

1. Park on a level surface, set the parking brake firmly and shift an automatic transmission into PARK (P). Shift a manual transmission into REVERSE (R). Lower both windows and sunshades and turn the ignition key to LOCK.
2. Press either the storage compartment lid release button behind the driver's seat or in the center console.
3. Turn the latch handles outward. Pull the top up and forward until it lines up with the windshield.
4. Latch the top by turning the handles toward the center of the vehicle. If needed, push down on the outside corners.
5. Lift the rear of the top and close the compartment lid firmly.

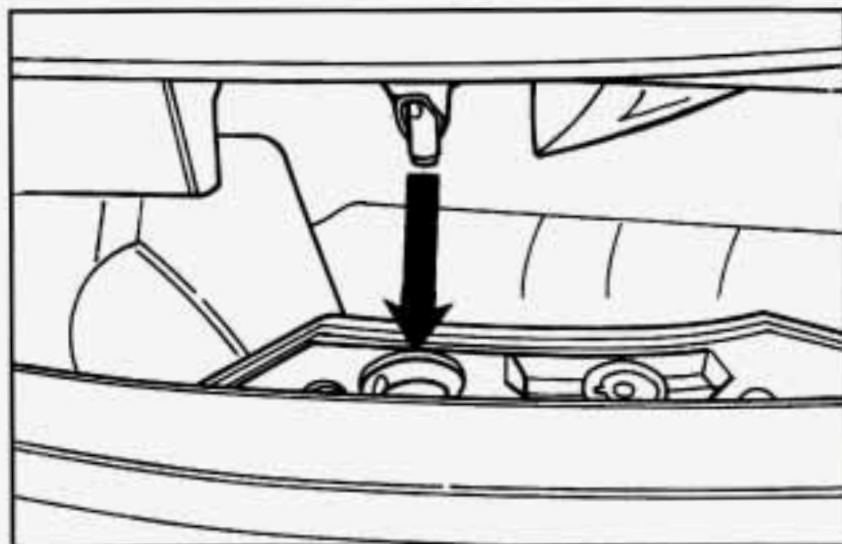

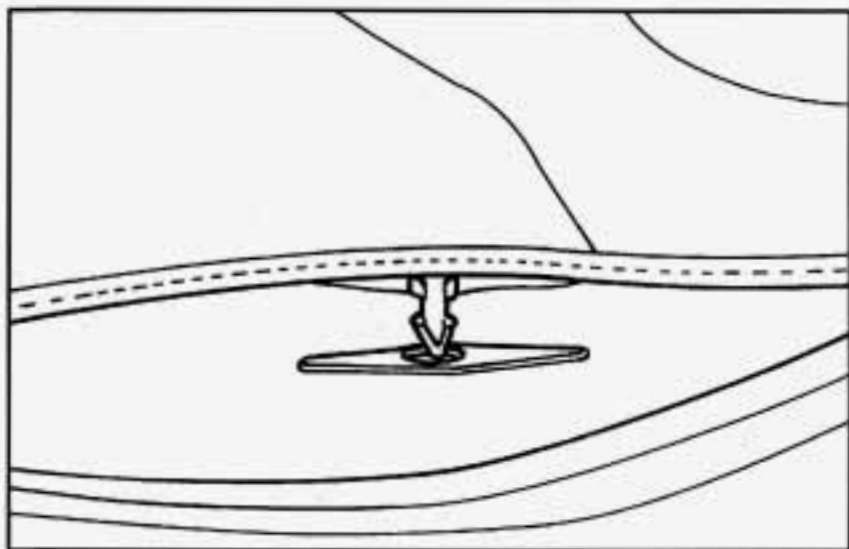

6. Lower the rear of the top so the latch pins align with the holes in the lid. To secure the rear of the top, push down firmly on both corners.

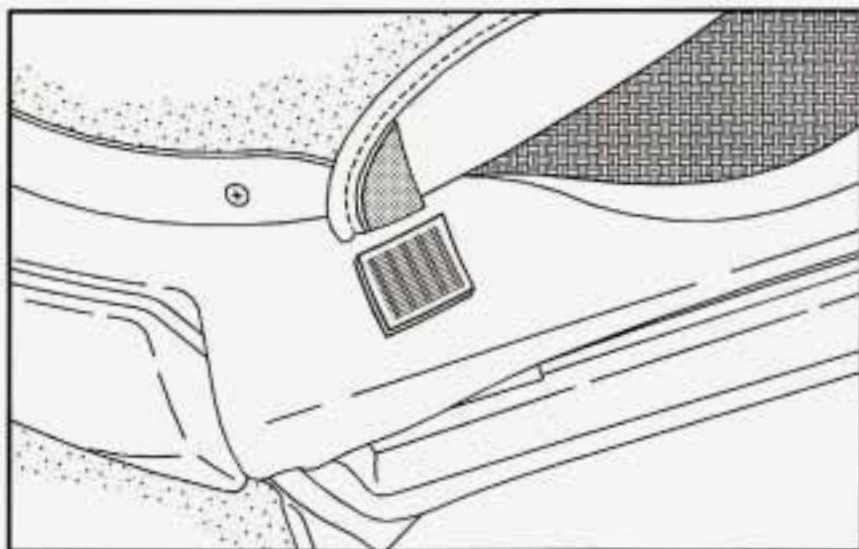

7. Fasten the strips for the headliner at the rear of each window opening.

NOTICE:

Certain automatic car washes may cause damage to your vehicle. The top fabric can be damaged by top cleaning brushes.

Please be aware that when you raise the convertible top, the bottom edge rests on a clear, protective tape strip. This protective strip protects your Corvette from paint damage so it should not be removed.

For care and cleaning of your convertible top, see "Cleaning Your Convertible Top" in the Index.

Convertible Hardtop (Option)

The convertible hardtop is designed for extended use in both warm and cold weather. The installation and removal of this top requires two people and takes about 30 minutes. You will need the wrench and ratchet stored in your center console. For information on cleaning your convertible hardtop, see "Cleaning" in the Index.

Removing Your Convertible Hardtop

1. Park on a level surface, set the parking brake firmly and shift an automatic transmission into PARK (P). Shift a manual transmission into REVERSE (R). Lower both windows and sunshades and turn the ignition key to LOCK.

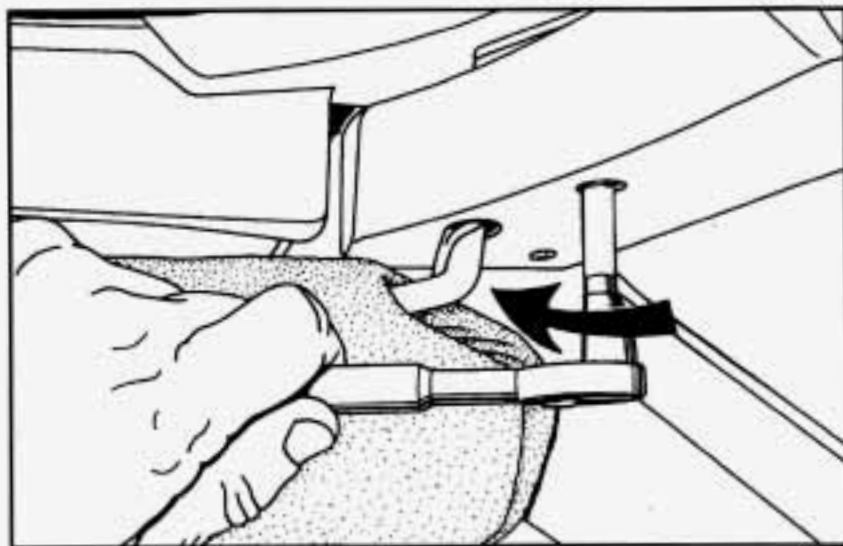

2. Loosen the front bolts with the wrench.

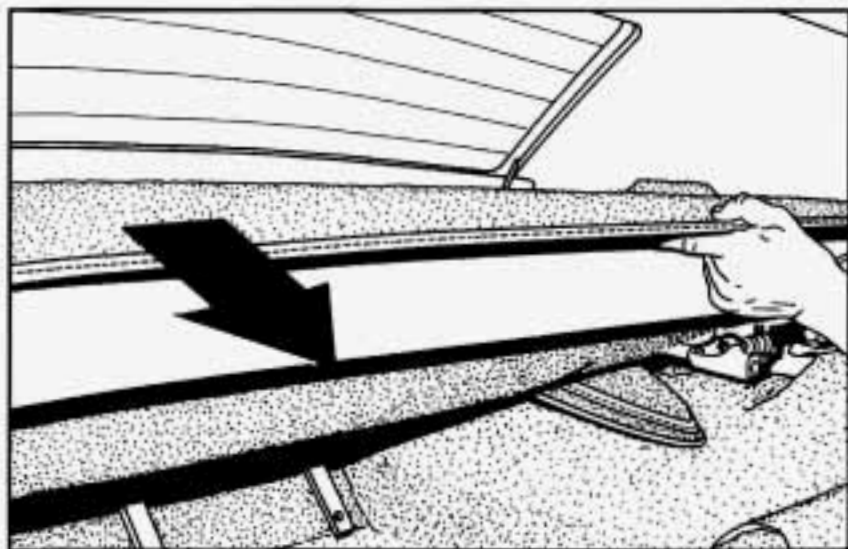

3. Move both seatbacks forward and remove the rear trim panel.

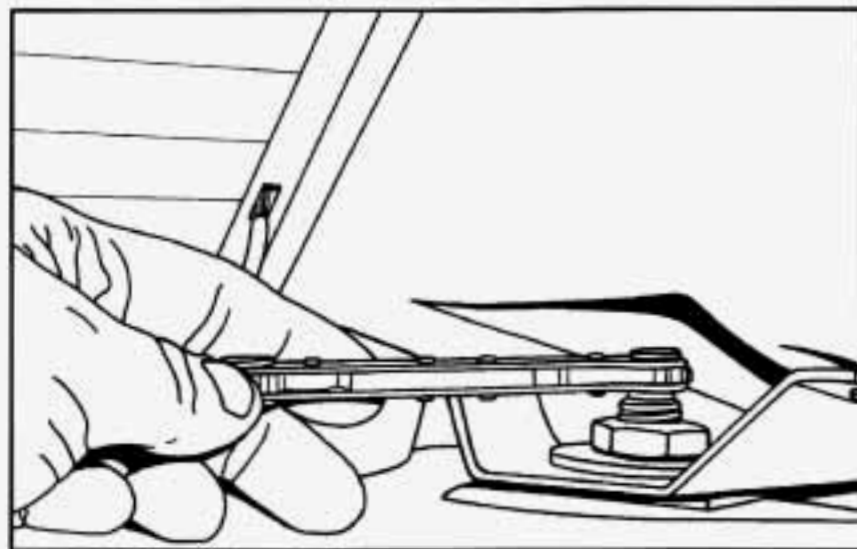

4. Loosen the rear corner bracket bolts with the ratchet.

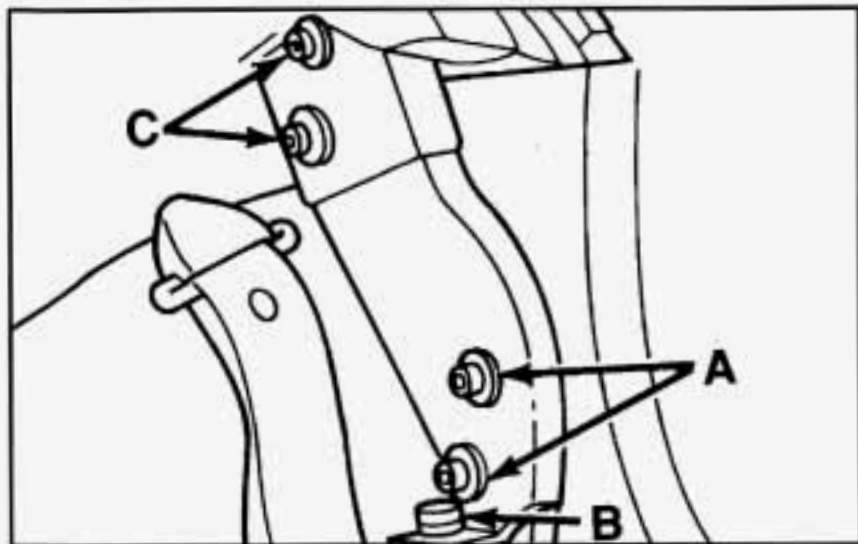

5. Using the wrench, remove the two lower bolts (A) from the lock pillar bracket on each side.
6. Remove the bolt (B) from the bottom flange of each lock pillar bracket.
7. Then remove the two upper bolts (C) from the receiver bracket on each side.

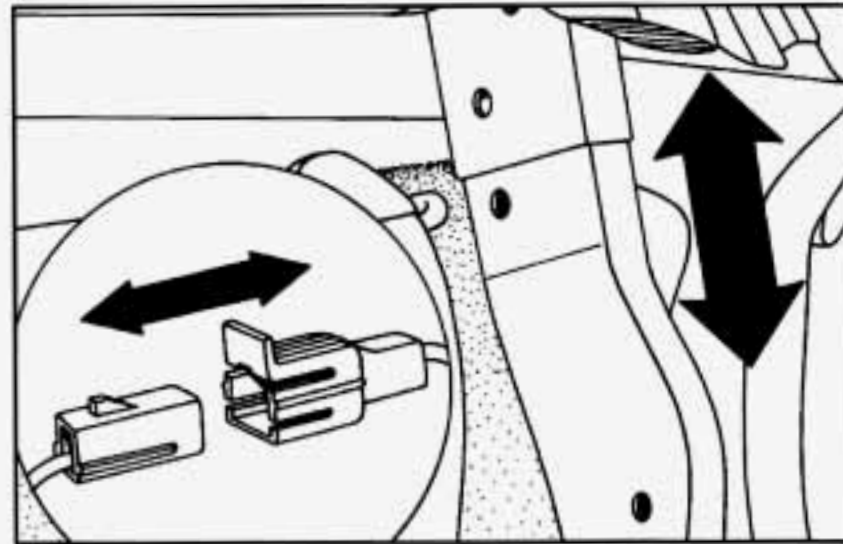

8. Slide both lock pillar brackets down and forward from the receiver brackets. You may need to lift the hardtop slightly to remove the brackets.
9. Disconnect both wire connectors located behind the lock pillar brackets. These are the rear window defogger wires.



NOTICE:

To help avoid damaging the hardtop when not in use:

- Store the hardtop in its normal position, resting on its mounting brackets.
- Store hardware and trim panel with the hardtop.

10. With one person on each side, gently lift the hardtop approximately 8 inches (200 mm) straight up. Remove the hardtop over the rear of the vehicle.
11. Install the HATCH (45) fuse to enable the storage compartment lid release button and center console release switch. You will need the fuse installed if you have to raise your convertible top.

The fuse that enables these releases is not installed at the assembly plant and should be in your center console. See "Instrument Panel Fuse Block" in the Index for location of the fuse.

12. Connect the rear window defogger electrical connectors.

Installing Your Convertible Hardtop

1. Park on a level surface, set the parking brake firmly and shift an automatic transmission into PARK (P). Shift a manual transmission into REVERSE (R). Lower both windows and sunshades. Turn off the radio to lower the power antenna and turn the ignition key to the LOCK position.
2. Disconnect both rear window defogger electrical connectors behind the lock pillar.
3. Lower the convertible top. Refer to "Convertible Top" in the Index.

This procedure will require the use of the storage compartment lid release button behind the driver's seat or the center console release switch. The fuse that enables these releases is not installed at the assembly plant and should be in your center console. See "Instrument Panel Fuse Block" in the Index for location of the fuse. The fuse is labeled HATCH (45).

4. With one person on each side, carefully position the hardtop over the vehicle. Lower the hardtop slowly, aligning the rear bolt spacers onto the bezels, and front conical nuts into the tapered receivers. Realign the hardtop, if necessary.

NOTICE:

To help avoid damage, don't force the rear of the hardtop down. The hardtop may rest slightly above the storage compartment lid until the release lever is pulled. See Step 8 in this procedure.

5. Move both seatbacks forward. Slide the lock pillar bracket into the receiver bracket until the scribed line is even with the lower edge of the receiver bracket.
6. Connect the electrical connectors and make sure they are inside the vehicle.

7. Insert the two upper bolts into both receiver brackets. You may have to lift the hardtop slightly to install the lock pillar bracket.
8. If the hardtop hasn't lowered into position, pull the release lever behind the driver's seat (located under the storage compartment lid).
9. Secure but don't tighten the rear corner bracket bolts using the ratchet.
10. Tighten the front bolts using the wrench.
11. Insert the lower bolt into the bottom flange of the lock pillar brackets and tighten. Install and tighten the remaining bolts into the lock pillar brackets.
12. Using the ratchet, tighten the rear corner bracket bolts. Do not over-tighten these bolts.
13. Slide the rear trim panel in place.



CAUTION:

If the hardtop isn't secure, it can't give as much protection in a crash. A loose hardtop could fly off the vehicle in an accident or sudden maneuver. You or others could be injured. Don't drive your vehicle until all the hardtop fasteners are tight.

14. Remove the HATCH (45) fuse. Store it in the center console while the convertible hardtop is in use. (This will prevent accidental unlatching of the storage compartment lid.)

Instrument Panel

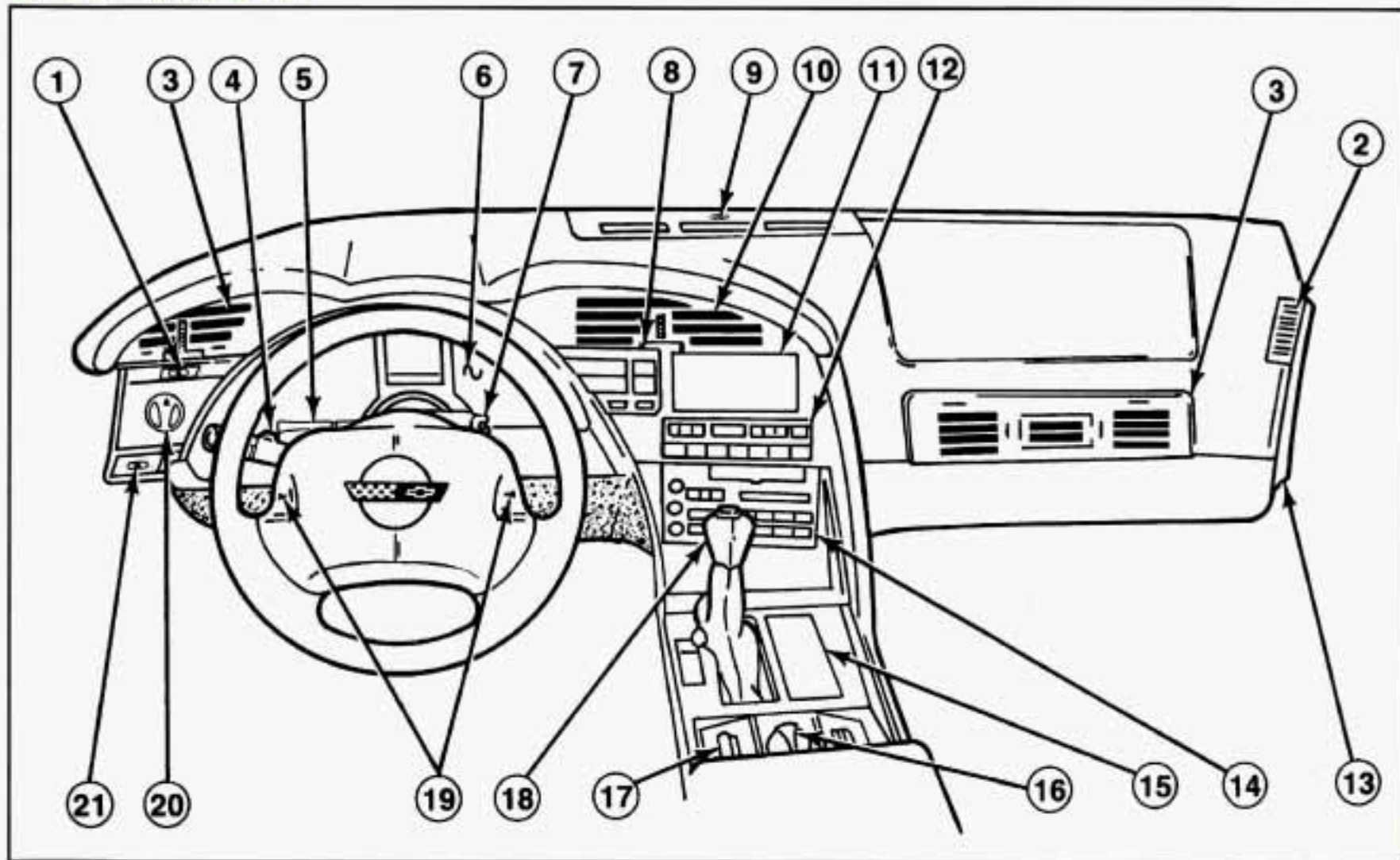

1. Acceleration Slip Regulation (ASR) Switch
2. Side Window Defogger Vent
3. Side Air Vent
4. Turn Signal/Multifunction Lever
5. Tilt Lever
6. Instrument Cluster
7. Ignition Switch
8. Trip Monitor Controls
9. Solar Sensor
10. Center Air Vent
11. Driver Information Center
12. Comfort Controls
13. Fuse Panel
14. Audio System
15. Ashtray/Lighter/Cupholder
16. Ride Control (Option)
17. Power Seat Control (Option)
18. Shift Lever (Automatic Shown)
19. Horn
20. Main Lamp Control
21. Fog Lamp Switch

Instrument Panel Cluster

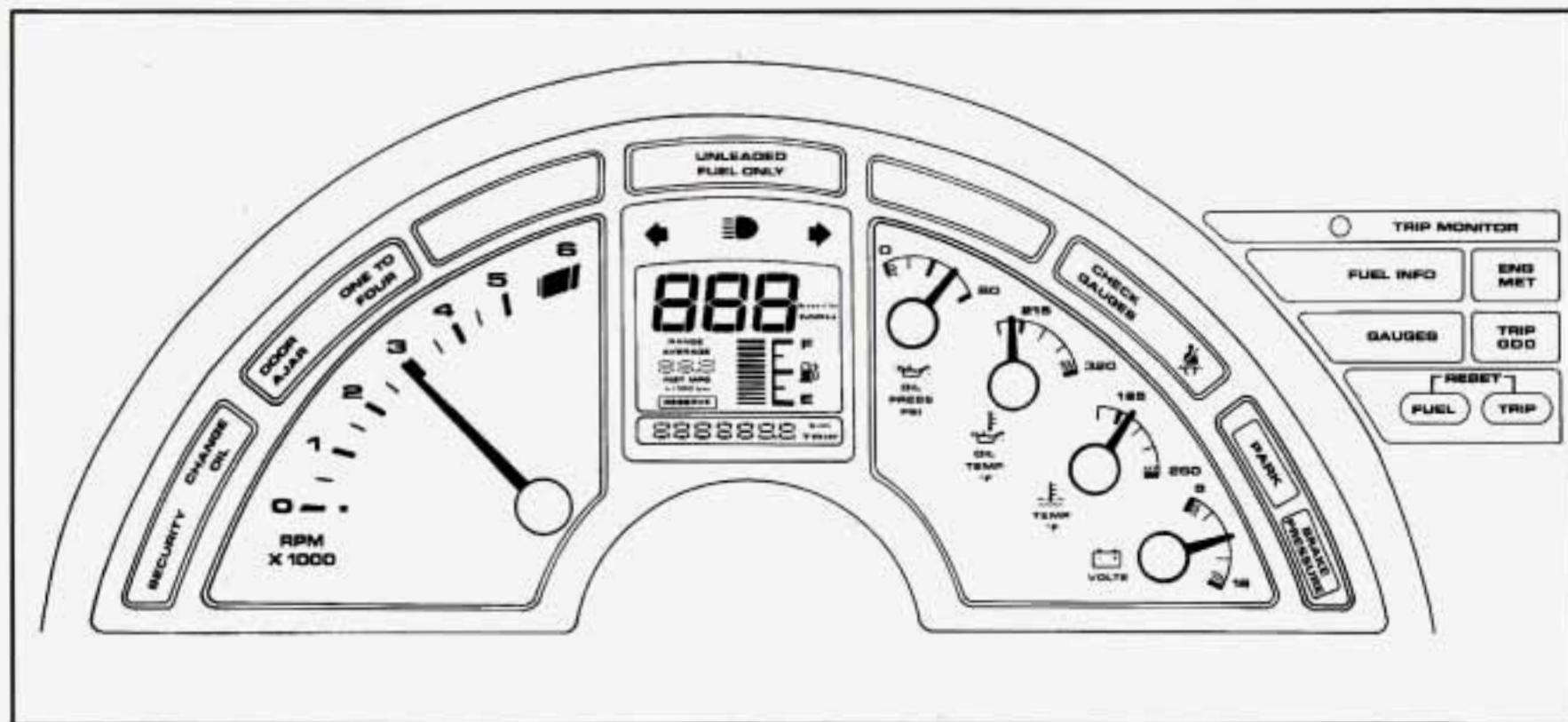

LT1 Engine

Your instrument cluster and Driver Information Center are designed to let you know at a glance how your vehicle is running. You'll know how fast you're going, about how much fuel you have left and many other things you'll need to know to drive safely and economically. The center display in the cluster is controlled by the trip monitor.

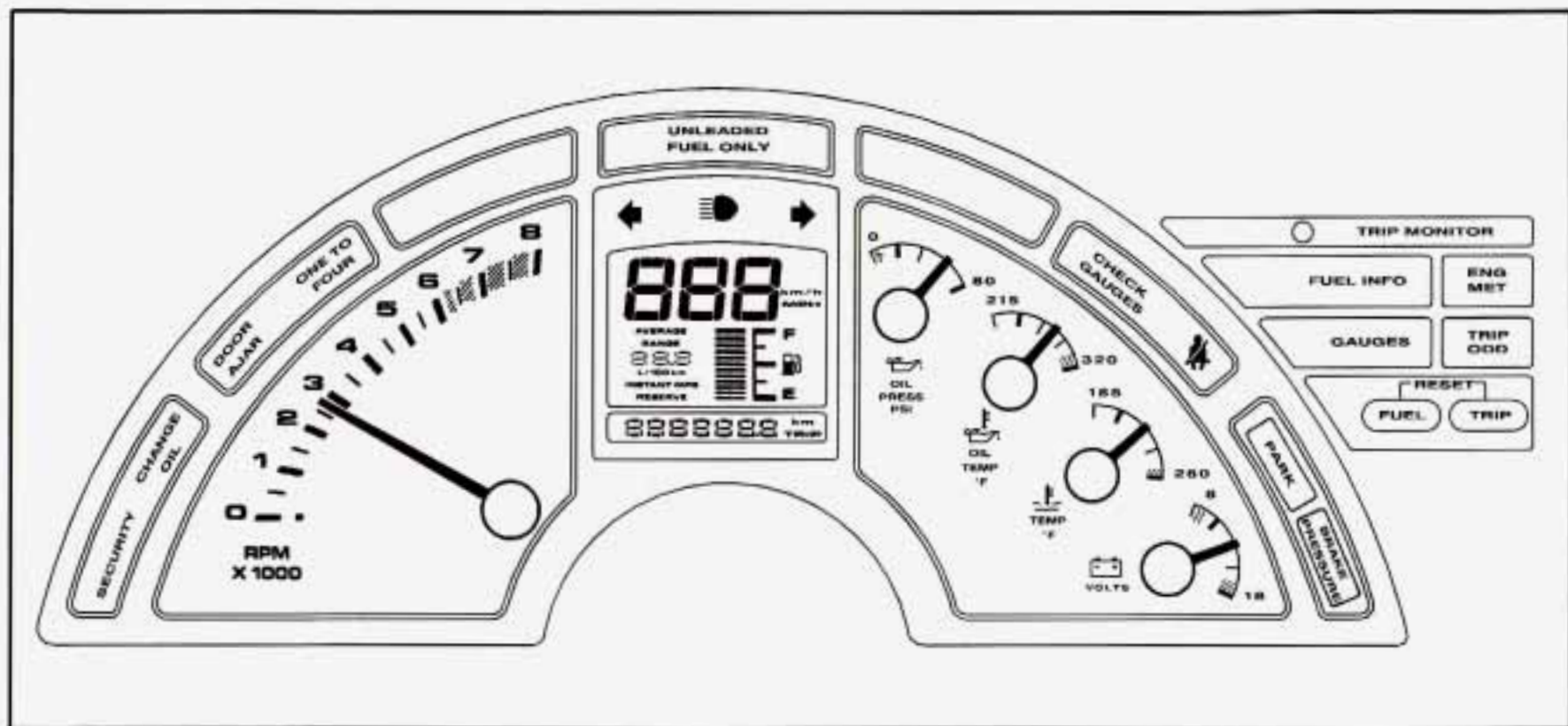

LT4 Engine

Speedometer and Odometer

Your speedometer lets you see your speed in either miles per hour (mph) or kilometers per hour (km/h). Your odometer shows how far your vehicle has been driven, in either miles or kilometers. Press the ENG MET button on the trip monitor to switch the display between English units (miles) and metric units (kilometers).

Your Corvette's odometer is tamper-resistant. It will read ODO ERR if someone has tampered with it.

If a new odometer is installed, it will automatically reset to the correct reading. If an electrical or other problem makes setting the odometer correctly impossible, then it's set at zero, but a label on the driver's door must show the old reading and when the new one was installed.

Trip Odometer

The trip odometer can tell you how far your Corvette has been driven since you last set the trip odometer to zero.

To display the trip odometer, press TRIP ODO on the Trip Monitor. To reset it, press and hold RESET TRIP for two seconds.

Tachometer

The tachometer displays the engine speed in thousands of revolutions per minute (rpm).

Fuel will shut off at about 6400 rpm for the LT4 (Code 5) engine and at about 5850 rpm for the LT1 (Code P) engine.

If you continue to drive your Corvette at the fuel shut off rpm, you could damage your engine. Be sure to operate your Corvette below the fuel shut off rpm or reduce your rpm quickly when the fuel shuts off.

Warning Lights, Gauges and Indicators

This part describes the warning lights and gauges that may be on your vehicle. The pictures will help you locate them.

Warning lights and gauges can signal that something is wrong before it becomes serious enough to cause an expensive repair or replacement. Paying attention to your warning lights and gauges could also save you or others from injury.

Warning lights come on when there may be or is a problem with one of your vehicle's functions. As you will see in the details on the next few pages, some warning lights come on briefly when you start the engine just to let you know they're working. If you are familiar with this section, you should not be alarmed when this happens.

Gauges can indicate when there may be or is a problem with one of your vehicle's functions. Often gauges and warning lights work together to let you know when there's a problem with your vehicle.

When one of the warning lights comes on and stays on when you are driving, or when one of the gauges shows there may be a problem, check the section that tells you what to do about it. Please follow this manual's advice. Waiting to do repairs can be costly -- and even dangerous. So please get to know your warning lights and gauges. They're a big help.

Your vehicle also has a Driver Information Center that works along with the warning lights and gauges. See "Driver Information Center" in the Index.

Safety Belt Reminder Light

When the key is turned to RUN or START, a chime will come on for about eight seconds to remind people to fasten their safety belts, unless the driver's safety belt is already buckled.



The safety belt light will also come on and stay on until the driver's belt is buckled.

Air Bag Readiness Light

There is an air bag readiness light on the instrument panel, which shows AIR BAG. The system checks the air bag's electrical system for malfunctions. The light tells you if there is an electrical problem. The system check includes the air bag sensors, the air bag modules, the wiring and the diagnostic module. For more information on the air bag system, see "Air Bag" in the Index.



You will see this light flash for a few seconds when you turn your ignition to RUN or START. Then the light should go out. This means the system is ready.

If the air bag readiness light doesn't come on when you start your vehicle, or stays on, or comes on when you are driving, your air bag system may not work properly. Have your vehicle serviced right away.

Charging System Indicator Light

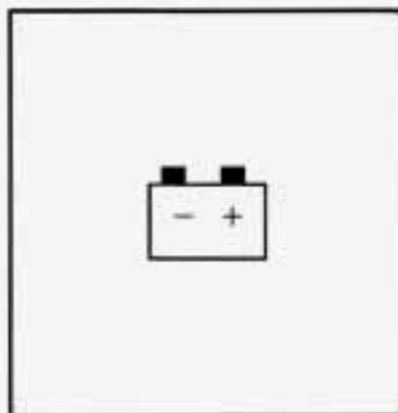

This light will come on when you turn on the ignition, but the engine is not running, as a check to show you it is working. It should go out when the engine starts.

If it stays on or comes on while you are driving, you may have a problem with the electrical charging system. It could indicate that you have a loose or broken drive belt or another electrical problem. Have it checked right away. Driving while this light is on could drain your battery.

If you must drive a short distance with the light on, be certain to turn off all your accessories, such as the radio and air conditioner.

Voltmeter

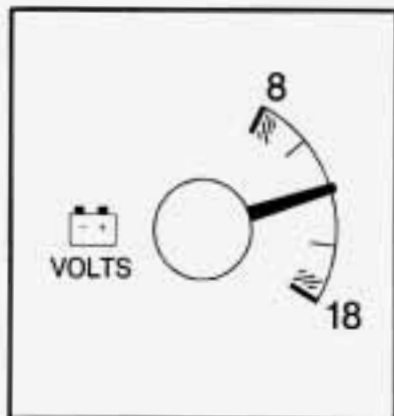

When the engine is not running, the voltmeter shows the voltage output of your battery. When the engine is running, it shows the voltage output of the charging system.

Readings between the shaded areas show the normal operating range. The reading will change as the rate of charge changes (with engine speed, for example), but if the voltmeter reads in either shaded area, and it stays there, you may have a problem with the charging system. Have it checked right away. Driving with the voltmeter reading in a shaded area could drain your battery.

If you must drive a short distance with the voltmeter reading in a shaded area, turn off all your accessories, including your comfort controls and audio systems.

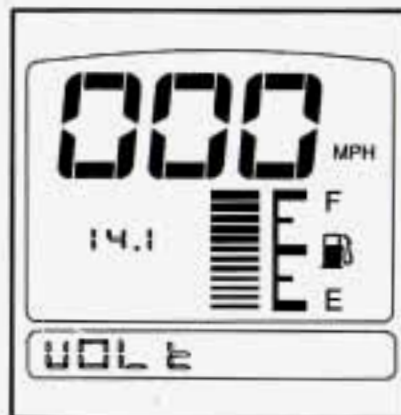

For numeric gauge measurements, press the GAUGES button on the trip monitor until VOLT appears. The number that appears next to the fuel gauge is the battery voltage.

Brake System Warning Light

Your Corvette's hydraulic brake system is divided into two parts. If one part isn't working, the other part can still work and stop you. For good braking, though, you need both parts working well.

**BRAKE
PRESSURE**

This light should come on when you turn the ignition key to START. If it doesn't come on then, have it fixed so it will be ready to warn you if there's a problem.

If this warning light stays on after you start your engine, there could be a brake problem. Have your brake system inspected right away.

If the light comes on while you are driving, pull off the road and stop carefully. You may notice that the pedal is harder to push. Or, the pedal may go closer to the floor. It may take longer to stop. If the light is still on, have the vehicle towed for service. (See "Towing Your Vehicle" in the Index.)



CAUTION:

Your brake system may not be working properly if the brake warning light is on. Driving with the brake warning light on can lead to an accident. If the light is still on after you've pulled off the road and stopped carefully, have the vehicle towed for service.

Parking Brake Indicator Light



When the ignition is on, this light will come on when you set your parking brake. The light will stay on if your parking brake doesn't release fully.

This light should also come on when you turn the ignition key to START. If it doesn't come on then, have it fixed so it will be ready to remind you if the parking brake hasn't released fully.

Anti-Lock Brake System Warning Light

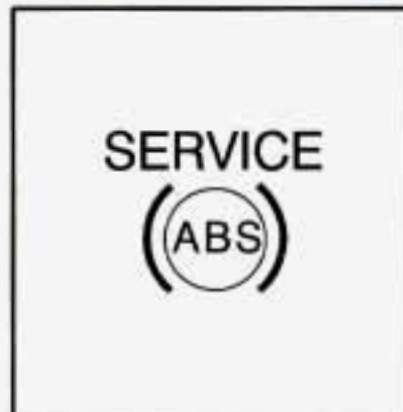

With the anti-lock brake system, this light will come on when you start your engine and may stay on for several seconds. That's normal.

If the light stays on, turn the ignition off. Or, if the light comes on when you're driving, stop as soon as possible and turn the ignition off. Then start the engine again to reset the system. If the light still stays on, or comes on again while you're driving, your Corvette needs service. If the regular brake system warning light isn't on, you still have brakes, but you don't have anti-lock brakes. If the regular brake system warning light is also on, you don't have anti-lock brakes and there's a problem with your regular brakes. See "Brake System Warning Light" earlier in this part.

The anti-lock brake system warning light should come on briefly when you turn the ignition key to RUN.

If the light doesn't come on, have it fixed so it will be ready to warn you if there is a problem.

Anti-Lock Brake System Active Light

A square box with a black border containing the text "ABS ACTIVE" in bold, black, sans-serif capital letters, centered.

**ABS
ACTIVE**

When your anti-lock system is adjusting brake pressure to help avoid a braking skid, the anti-lock brake system active light will come on.

Slippery road conditions may exist if this light comes on, so adjust your driving accordingly. The light will stay on for a few seconds after the system stops adjusting brake pressure.

The anti-lock brake system active light also comes on briefly when you turn the ignition key to RUN. If the light doesn't come on then, have it fixed so it will be there to tell you when the system is active.

ASR (Acceleration Slip Regulation) System Warning Light

A square box with a black border containing the text "SERVICE ASR" in bold, black, sans-serif capital letters, centered.

**SERVICE
ASR**

This warning light should come on briefly as you start the engine. If the warning light doesn't come on then, have it fixed so it will be ready to warn you if there's a problem.

If it stays on, or comes on when you're driving, there's a problem with your ASR system and your vehicle needs service. When this warning light is on, the system will not limit wheel spin. Adjust your driving accordingly. (The ASR OFF light will also come on when the ASR system warning light comes on.)

ASR (Acceleration Slip Regulation) System Active Light



When your ASR system is limiting wheel spin, this light will come on. Slippery road conditions may exist if the ASR system active light comes on, so adjust your driving accordingly.

The light will stay on for a few seconds after the ASR system stops limiting wheel spin.

The ASR system active light also comes on briefly when you turn the ignition key to RUN. If the light doesn't come on then, have it fixed so it will be there to tell you when the system is active.

ASR (Acceleration Slip Regulation) Off Light



This light will come on for a few seconds when you turn the ignition on. It also comes on and stays on when the ASR button is pressed to turn the system off.

If the SERVICE ASR and ASR OFF lights come on and stay on when you're driving, there's a problem with your ASR system and your vehicle needs service. See "Acceleration Slip Regulation System" in the Index.

Engine Coolant Temperature Gauge

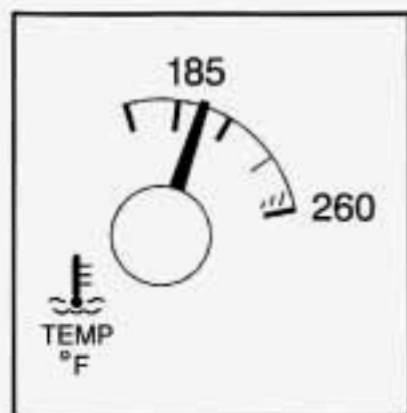

This gauge shows the engine coolant temperature. If the gauge pointer moves into the shaded area, your engine is too hot!

It means that your engine coolant has overheated. If you have been operating your vehicle under normal driving conditions, you should pull off the road, stop your vehicle and turn off the engine as soon as possible.

In "Problems on the Road," this manual shows what to do. See "Engine Overheating" in the Index.

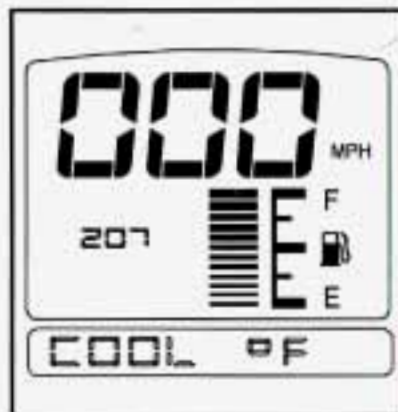

For numeric gauge measurements, press the GAUGES button on the trip monitor until COOL appears.

The number that appears next to the fuel gauge is the coolant temperature. If LO appears, the temperature is below 32°F (0°C).

Low Coolant Warning Light

**LOW
COOLANT**

This light comes on when the coolant in the system is low. You may need to add coolant. See “Engine Overheating” in the Index.

NOTICE:

Driving with the LOW COOLANT light on could cause your Corvette to overheat. See “Engine Overheating” in the Index. Your Corvette could be damaged and it wouldn’t be covered by your warranty.

Low Tire Pressure Warning Light (Option)

The Low Tire Pressure Warning System (LTPWS) has a sensor on each road wheel that transmits to a receiver on the instrument panel.

The system operates on a radio frequency subject to Federal Communications Commission (FCC) Rules.

This device complies with Part 15 of the FCC Rules. Operation is subject to the following two conditions: (1) This device may not cause harmful interference, and (2) This device must accept any interference received, including interference that may cause undesired operation.

Changes or modifications to this system by other than an authorized service facility could void authorization to use this equipment.

**LOW/FLAT
TIRE**

The LTPWS monitors air pressure in each road tire while you’re driving your Corvette. The LOW/FLAT TIRE light will come on whenever tire pressure in any road tire goes below 25 psi (170 kPa), and it will stay on until you turn off the ignition.

The light may come on if any LTPWS parts aren't working properly.

For LTPWS to work properly, you must drive your Corvette faster than 25 mph (40 km/h) and for more than 2 miles (4 km). The system will not warn you before you begin to drive that a tire is flat.

When the LOW/FLAT TIRE light comes on, check the tire pressure in all four road tires as soon as you can. Adjust the tire pressure as needed to those shown on the Tire-Loading Information label on the driver's door. If the light stays on after the tire pressure is adjusted, see your dealer.

 **CAUTION:**

When the LOW/FLAT TIRE warning light is on, your vehicle's handling capabilities will be reduced during severe maneuvers. If you drive too fast, you could lose control of your vehicle. You or others could be injured. Don't drive over 55 mph (90 km/h) when the LOW/FLAT TIRE warning light is on. Drive cautiously, and check your tire pressures as soon as you can.

NOTICE:

Driving with a flat tire may damage the tire, the wheel or the tire pressure sensor installed inside the tire on the wheel rim. Using tire sealants may also damage the sensor.

If you have EMTs, see "Extended Mobility Tires" in the Index.

The LTPWS sensor is directly opposite the valve stem on the tire. Take care when servicing or having your tires serviced. The sensors may not work properly if damaged. To prevent damage to the sensors, see the 1996 Corvette Service Manual for correct tire mounting and dismounting procedures.

The LOW/FLAT TIRE light may come on if your vehicle is close to another vehicle that has LTPWS and has a tire with low pressure.

LTPWS can warn you about a low tire, but it does not replace normal tire maintenance. See "Tires" in the Index.

Service LTPWS Light (Option)



The SERVICE LTPWS light comes on whenever a LTPWS part is not working properly. It may also come on when you're going less than 25 mph (40 km/h) or in stop-and-go traffic.

The light will go out when the electronic receiver gets a signal from each sensor.

Check the system by turning the ignition on. The light should come on and then go out. See your dealer if the light stays on or doesn't come on.

Here are two situations that cause the SERVICE LTPWS light to come on and stay on. Both of these situations are normal and do not indicate that anything is wrong with your Corvette.

- You turn the ignition on three times in a row within half an hour without moving your Corvette. The light will then come on every time you turn the ignition on until you move your Corvette.
- You run your Corvette three times within half an hour while all four sensors are missing. (All the sensors would be missing, for example, if you put different wheels on your Corvette without transferring the sensors.)

If you would like to clear the SERVICE LTPWS light from your Driver Information Center permanently, see your dealer.

If the light comes on and stays on, even when the vehicle is driven, there may be a problem with LTPWS. See your dealer.

Malfunction Indicator Lamp (Service Engine Soon Light)



Your Corvette is equipped with a computer which monitors operation of the fuel, ignition and emission control systems.

This system is called OBD II (On-Board Diagnostics-Second Generation) and is intended to assure that emissions are at acceptable levels for the life of the vehicle, helping to produce a cleaner environment. (In Canada, OBD II is replaced by Enhanced Diagnostics.) The SERVICE ENGINE SOON light comes on to indicate that there is a problem and service is required. Malfunctions often will be indicated by the system before any problem is apparent, which may prevent more serious damage to your vehicle. This system is also designed to assist your service technician in correctly diagnosing any malfunction.

NOTICE:

If you keep driving your vehicle with this light on, after a while, your emission controls won't work as well, your fuel economy won't be as good and your engine may not run as smoothly. This could lead to costly repairs that may not be covered by your warranty.

This light should come on, as a check to show you it is working, when the ignition is on and the engine is not running. If the light doesn't come on, have it repaired. This light will also come on during a malfunction in one of two ways:

- **Light Flashing** -- A misfire condition has been detected. A misfire increases vehicle emissions and may damage the emission control system on your vehicle. Dealer or qualified service center diagnosis and service is required.
- **Light On Steady** -- An emission control system malfunction has been detected on your vehicle. Dealer or qualified service center diagnosis and service may be required.

If the Light Is Flashing

The following may prevent more serious damage to your vehicle:

- Reduce vehicle speed.
- Avoid hard accelerations.
- Avoid steep uphill grades.

If the light stops flashing and remains on steady see “If the Light Is On Steady” following.

If the light continues to flash, when it is safe to do so, *stop the vehicle*. Put your vehicle in PARK (P). Turn the key off, wait at least 10 seconds and restart the engine.

If the light remains on steady, see “If the Light Is On Steady” following. If the light is still flashing follow the previous steps, and drive the vehicle to your dealer or qualified service center for service.

If the Light Is On Steady

You may be able to correct the emission system malfunction by considering the following:

Did you just put fuel into your vehicle?

If so, reinstall the fuel cap, making sure to fully install the cap. The diagnostic system can determine if the fuel cap has been left off or improperly installed. This will allow fuel to evaporate into the atmosphere. A few driving trips should turn the light off.

Did you just drive through a deep puddle of water?

If so, your electrical system may be wet. The condition will usually be corrected when the electrical system dries out. A few driving trips should turn the light off.

Are you low on fuel?

As your engine starts to run out of fuel, your engine may not run as efficiently as designed since small amounts of air are sucked into the fuel line causing a misfire. The system can detect this. Adding fuel should correct this condition. Make sure to install the fuel cap properly. It will take a few driving trips to turn the light off.

Have you recently changed brands of fuel?

If so, be sure to fuel your vehicle with quality fuel (see "Fuel" in the Index). Poor fuel quality will cause your engine not to run as efficiently as designed. You may notice this as stalling after start-up, stalling when you put the vehicle into gear, misfiring, hesitation on acceleration or stumbling on acceleration. (These conditions may go away once the engine is warmed up.) This will be detected by the system and cause the light to turn on.

If you experience this condition, change the fuel brand you use. It will require at least one full tank of the proper fuel to turn the light off.

If none of the above steps have made the light turn off, have your dealer or qualified service center check the vehicle. Your dealer has the proper test equipment and diagnostic tools to fix any mechanical or electrical problems that may have developed.

Low Oil Light

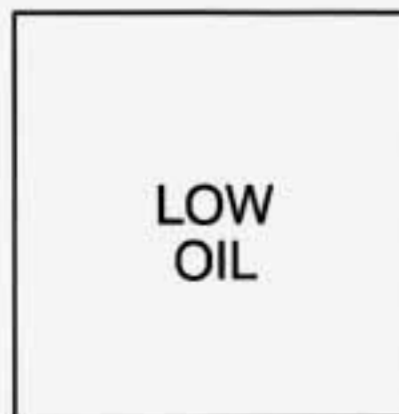

This light should come on while you are starting your engine. If the light doesn't come on, have it repaired. If the light comes on while starting your engine and stays on, your engine oil level may be too low. You may need to add oil. See "Engine Oil" in the Index.

Engine Oil Pressure Gauge

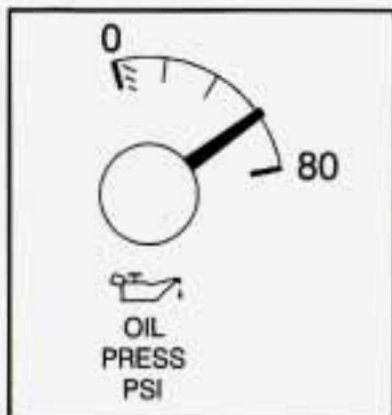

The engine oil pressure gauge shows the engine oil pressure in psi (pounds per square inch) or kPa (kilopascals) when the engine is running.

Oil pressure should be 20 to 80 psi (140 to 550 kPa). (In certain situations such as long, extended idles on hot days, it could read as low as 6 psi (40 kPa) and still be considered normal.) It may vary with engine speed, outside temperature and oil viscosity, but readings above the shaded area show the normal operating range. Readings in the shaded area tell you that the engine is low on oil, or that you might have some other oil problem. See "Engine Oil" in the Index.

CAUTION:

Don't keep driving if the oil pressure is low. If you do, your engine can become so hot that it catches fire. You or others could be burned. Check your oil as soon as possible and have your vehicle serviced.

NOTICE:

Damage to your engine from neglected oil problems can be costly and is not covered by your warranty.

Engine Oil Temperature Gauge

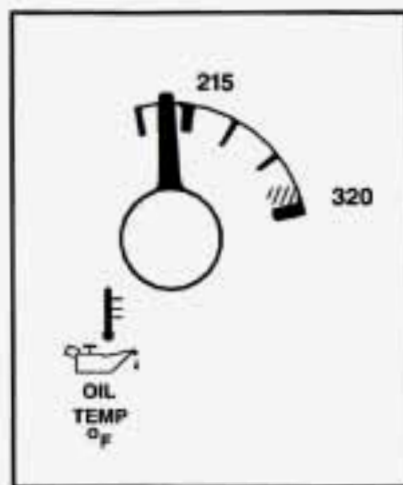

This gauge shows your engine oil temperature. Oil temperature may vary with the type of driving you do and weather conditions.

If your gauge pointer moves close to or into the shaded area and stays there, your oil temperature is too high. Check the engine coolant temperature and engine oil level. If your engine is too hot, see “Engine Overheating” in the Index. Your vehicle may need service; see your dealer.

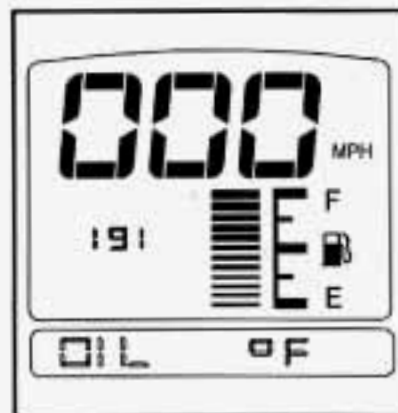

For numeric gauge measurements, press the GAUGES button on the trip monitor until OIL appears.

The number that appears next to the fuel gauge is the oil temperature. If LO appears, the temperature is below 32°F (0°C).

Engine Oil Life Monitor



The CHANGE OIL light comes on for a few seconds when you turn the ignition on. It will come on and stay on when it's time to change your oil.

The monitor uses oil temperature and engine revolutions to decide when the oil is nearly worn out. The light is only a reminder, though.

Be sure to reset the monitor when your oil is changed, even if the CHANGE OIL light didn't come on. If you don't reset the monitor, it won't work correctly. Follow these steps:

1. Turn the key to RUN, but don't start the engine.
2. Press ENG MET on the trip monitor. Then, within five seconds, press it again.
3. Within five seconds, press and hold GAUGES on the trip monitor. The CHANGE OIL light should flash.
4. Hold the GAUGES button until the CHANGE OIL light stops flashing and goes out. This should take about 10 seconds.

When the light goes out, the monitor is reset. If the monitor doesn't reset, turn the ignition off, then try again.

Service Ride Control Light (Option)

A square icon with a black border containing the text "SERVICE RIDE CONTROL" in all caps, centered.

**SERVICE
RIDE
CONTROL**

If your vehicle is equipped with Ride Control, this light should come on for a few seconds when you start your vehicle.

If the light stays on or comes on while you're driving, there may be a problem with your Ride Control system. You can still drive, but you should see your dealer soon.

The SERVICE RIDE CONTROL light may also come on if the selective ride control knob is not placed fully into a position. For example, if the selection position is between TOUR and SPORT or SPORT and PERF, the light may come on. If the light comes on for this reason, move the select switch to the desired position and the light should go out.

Passive Keyless Entry Light

A square icon with a black border containing the text "PASSIVE KEYLESS ENTRY" in all caps, centered.

**PASSIVE
KEYLESS
ENTRY**

This light will come on for about two seconds when you turn the ignition on, unless the passive feature of the keyless entry system is off. The light also comes on and flashes when you are programming transmitters.

See "Passive Keyless Entry System" in the Index.

Security Light



This light comes on to remind you to arm your theft-deterrent system. If it comes on and stays on when your ignition is on, there may be a problem with your theft-deterrent system.

See “Universal Theft-Deterrent” and “PASS-Key System” in the Index.

System Problems Light

If SYS flashes on the display near your fuel gauge, there may be a problem with your Corvette’s electrical system. If the SECURITY light flashes at the same time, there is a problem with your theft-deterrent system. Have your vehicle checked by your dealer if SYS keeps appearing.

Check Gauges Light



This light will come on briefly when you are starting the engine. If the light comes on and stays on while you are driving, check your gauges to see if they are in the warning areas.

This light can come on for:

- High Engine Oil Temperature or Low Oil Pressure
- High Coolant Temperature
- High or Low Battery Voltage
- Low Fuel Level
- High Automatic Transmission Fluid Temperature

Door Ajar Light



This light comes on when you open one of the doors with the ignition on. It stays on until you fully close the door. Have your vehicle serviced if the light comes on and stays on, even when the doors are fully closed.

Fuel Gauge

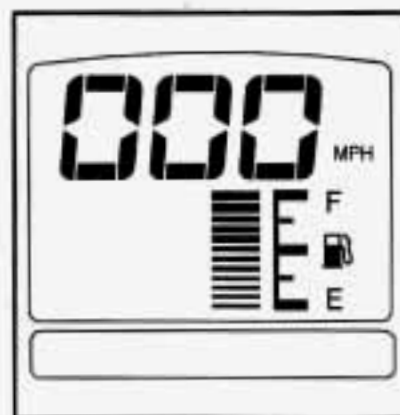

Your fuel gauge shows about how much fuel is in your tank. The bars light up when the ignition is on or, if the ignition is off, when you turn on your parking lamps.

When the display is down to the last two bars, RESERVE will appear next to the gauge.

Here are three concerns some owners have had about the fuel gauge. All these situations are normal and do not indicate that anything is wrong with the fuel gauge.

- At the gas station, the fuel pump shuts off before the gauge reads FULL (F).
- It takes more (or less) fuel to fill up than the gauge reads. For example, the gauge reads half full, but it took more (or less) than half of the tank's capacity to fill it.
- The gauge moves a little when you turn, stop or speed up.

You can use the trip monitor to display more detailed fuel information. Each time you press FUEL INFO, one of the following will appear next to the fuel gauge.

- **INST:** The fuel economy calculated for your current driving conditions.
- **AVERAGE:** The fuel economy calculated for the current tank of fuel, or since you last reset the display.
- **RANGE:** The distance you can drive before refueling.
- **BLANK:** The fuel gauge is displayed alone.

You should reset the fuel information display every time you refuel. To reset the display, press FUEL INFO until AVERAGE appears. Then, press RESET FUEL on the trip monitor.

Gauge Markings

The analog gauges provide a quick visual reference to the actual measurements of these gauges. However, you must keep in mind that the gauges aren't linear. This means that the middle mark is not a temperature halfway between the top and bottom temperatures on the gauge.

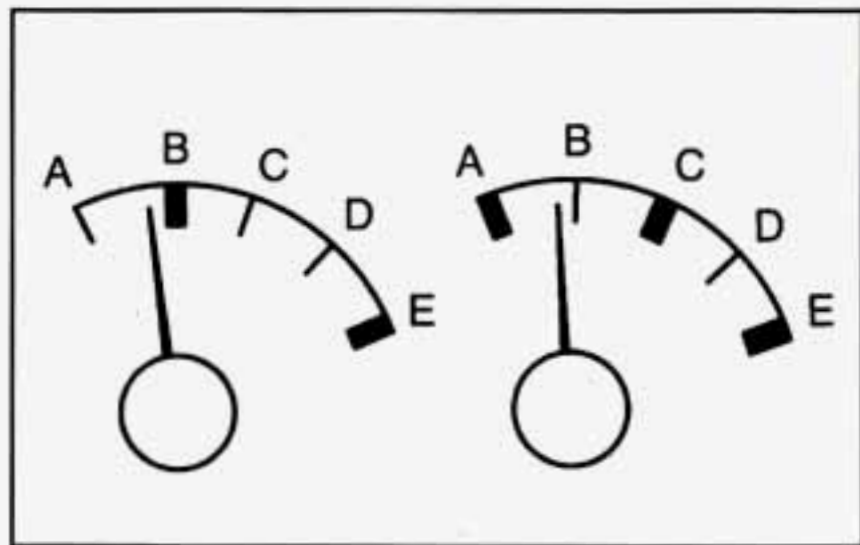

For your convenience, the following table gives the exact reading for each mark.

For numeric gauge measurements, refer to the digital readings by pressing GAUGES on the trip monitor.

| Gauge | Marking | | | | |
|---------------------|-----------------|------------------|------------------|------------------|------------------|
| | A | B | C | D | E |
| Oil Temperature | 100°F (38°C) | 215°F (102°C) | 250°F (121°C) | 285°F (145°C) | 320°F (160°C) |
| Coolant Temperature | 100°F (38°C) | 185°F (85°C) | 210°F (99°C) | 235°F (113°C) | 260°F (127°C) |

Automatic Transmission Fluid Temperature Reading

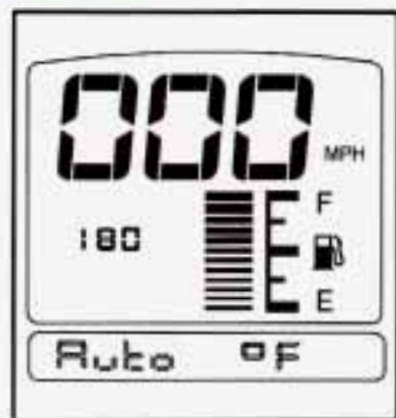

Automatic transmission fluid temperature will be displayed if you press the GAUGES button on the trip monitor until AUTO appears.

The number that appears next to the fuel gauge is the automatic transmission fluid temperature. If LO appears, the temperature is below 32°F (0°C).

It's normal for the transmission fluid temperature to vary, depending on the type of driving you do and weather conditions. If you drive on long grades on a hot day, the transmission fluid temperature will be higher than normal driving on a cold day. If you drive your Corvette at high speeds with a lot of stop-and-go or fast accelerations, your transmission fluid temperature may also be higher.

If the transmission fluid exceeds 280°F (138°C), the CHECK GAUGES light will come on and HI AUTO will be displayed next to the transmission fluid temperature when you toggle through the GAUGES button. You should move the shift lever to DRIVE (D) and continue driving at a slower, constant speed. Monitor the transmission fluid temperature and allow it to cool to 180°F (82°C) to 200°F (93°C). Then, you should check the transmission fluid level for a low fill or overfill condition and bring your Corvette in for service as soon as possible if the oil is too low or overfilled. (See "Automatic Transmission Fluid" in the Index.) Also, check the engine coolant temperature. If it's too hot, see "Cooling System" in the Index.

Driver Information Center

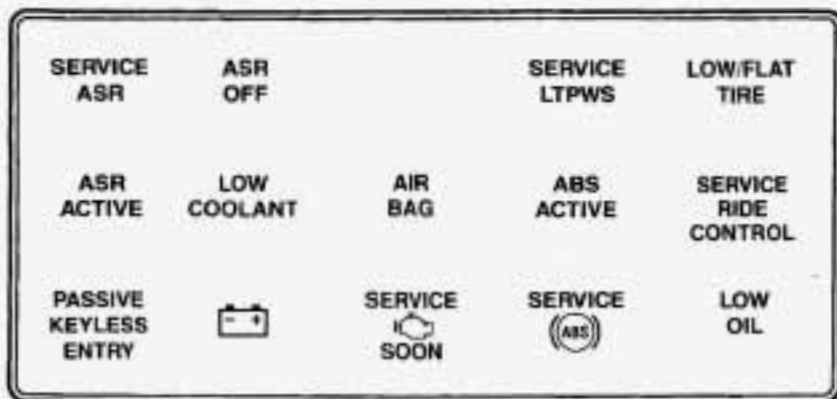

The Driver Information Center (DIC) gives you important safety and maintenance facts. It will display warning lights for the following:

- SERVICE ASR (Acceleration Slip Regulation)
- ASR OFF

- SERVICE LTPWS (Low Tire Pressure Warning System) (Option)
- LOW/FLAT TIRE
- ASR ACTIVE
- LOW COOLANT
- AIR BAG
- ABS ACTIVE (Anti-Lock Brake System Active)
- SERVICE RIDE CONTROL (Option)
- PASSIVE KEYLESS ENTRY
-  (Charging System)
- SERVICE ENGINE SOON
- SERVICE ABS
- LOW OIL

See "Lights" in the Index for additional information.



Section 3 Comfort Controls and Audio Systems

In this section you'll find out how to operate the comfort control and audio systems offered with your Corvette. Be sure to read about the particular systems supplied with your vehicle.

Comfort Controls

With these systems, you can control the heating, cooling and ventilation in your Corvette.

Your vehicle also has the flow-through ventilation system described later in this section.

Manual Climate Control System

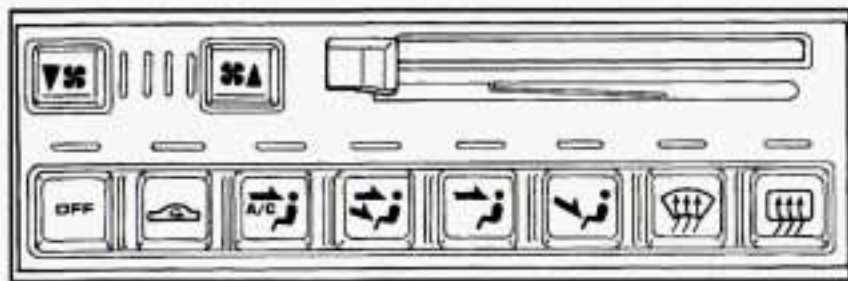

System Controls

Fan Control Buttons

Press the arrows on the fan switch to select the force of air you want.

Temperature Control Lever

Move the lever to change the temperature of the air flowing from the system. Move it to the right for warmer air and to the left for cooler air.

Air Control Buttons

OFF: The system is off.

 **RECIRCULATE:** Provides maximum cooling or quick cool-down on very hot days. This setting recirculates most of the air inside your vehicle. If it is used for long periods of time, the air may become dry. This setting directs air through the upper air vents. It will not work when the outside temperature is below freezing.

 **NORMAL A/C:** Use for normal cooling on hot days. This setting cools outside air and directs it through the instrument panel vents.

The air conditioning compressor operates in **NORMAL A/C**, as well as **RECIRCULATE**, **BI-LEVEL** and **DEFROST**. It only works when the outside temperature is above freezing. When the air conditioning compressor is on, you may sometimes notice slight changes in your vehicle's engine speed and power. This is normal because the system is designed to cycle the compressor on and off to keep the desired cooling and help fuel economy.

 **BI-LEVEL:** This setting cools or heats outside air and directs it through the instrument panel vents and the floor ducts.

 **VENT:** Air flows through the instrument panel vents. The air conditioning compressor does not run in **VENT** mode.

 **HEATER:** This setting directs most of the air through the floor ducts and some of the air through the defroster vents. The air conditioning compressor does not run in **HEATER** mode.

 **DEFROST:** This setting directs most of the air through the windshield defroster and side window defogger vents and some of the air through the floor ducts.

Heating

The heater works best if you keep your windows closed while using it.

Press **HEATER** and **FAN UP**, then slide the temperature control lever to a comfortable setting.

If your vehicle has an engine coolant heater and you use it in cold weather, 0°F (-18°C) or lower, your heating system can provide heat more quickly because the engine coolant is already warmed. See "Engine Coolant Heater" in the Index.

Bi-Level

You may want to use BI-LEVEL on cool, but sunny days. This setting directs outside air through the instrument panel vents and the floor ducts.

Press BI-LEVEL and FAN UP, then slide the temperature control lever to a comfortable setting.

Ventilation

For mild outside temperatures, when little heating or cooling is needed, you can still direct outside air through your vehicle.

Press VENT and FAN UP, then slide the temperature control lever to a comfortable setting.

Defogging and Defrosting

Your vehicle has several settings for clearing your windows. The air conditioning compressor will run to help remove moisture from the air.

To defrost the windshield quickly, press DEFROST and FAN UP, then slide the temperature control lever all the way to the right or to the FULL HOT position.

To defrost the side windows quickly, press BI-LEVEL and FAN UP. Then slide the temperature control lever all the way to the right. Direct airflow through the air conditioning outlets closest to the side windows.

Cooling

The air conditioner works best if you keep your windows closed. On very hot days, open the windows just long enough for the hot air to escape.

Press RECIRCULATE and FAN UP. Then slide the temperature control lever to a comfortable setting. Direct airflow through the air conditioning outlets closest to the side windows.

After cool-down, adjust the air control buttons to another setting. The compressor works in all settings except VENT and HEATER and at all temperatures above freezing.

When the air conditioning compressor is on, you may notice slight changes in your vehicle's engine speed and power. This is normal because the system is designed to cycle the compressor on and off to keep the desired temperature and help fuel economy.

Automatic Electronic Climate Control System (Option)

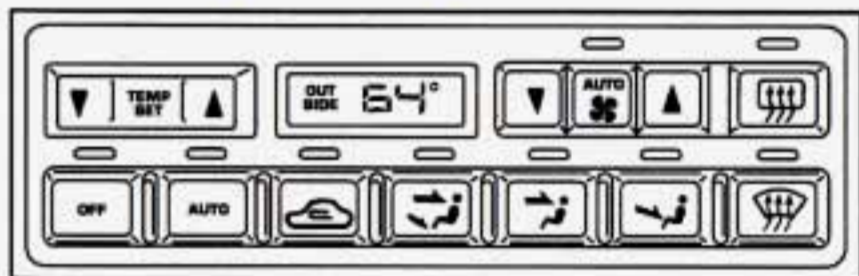

With this system, you set a temperature and then either let the system adjust airflow and force to maintain the temperature, or you can manually adjust flow and force.

System Controls

Fan Control Buttons

Press the arrows on the fan switch to select the force of air you want. Press AUTO FAN to let the system select the force of air.

Temperature Control Switch

Press the arrows on the TEMP SET switch to set the temperature you want in your vehicle. The temperature you select will show on the display for a few seconds, then the outside temperature will show.

Air Control Buttons

OFF: The system is off.

AUTO: The system controls airflow.

 **RECIRCULATE:** Provides maximum cooling or quick cool-down on very hot days. This setting recirculates most of the air inside your vehicle. If it is used for long periods of time, the air may become dry. This setting directs air through the upper air vents. It will not work when the outside temperature is below freezing.

 **BI-LEVEL:** This setting directs outside air through the instrument panel and side window defogger vents and the floor ducts.

 **VENT:** Outside air flows through the instrument panel vents.

 **HEATER:** This setting directs all of the air through the floor ducts.

 **DEFROST:** This setting directs most of the air through the windshield defroster and side window defogger vents and some of the air through the floor ducts.

 **DEFOG:** If you have the automatic system, this setting directs air to the floor and defroster vents.

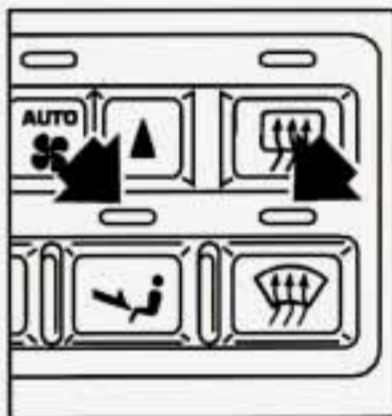

To turn on DEFOG, push the HEATER and DEFROST buttons at the same time. Both green lights above the buttons will come on to let you know that DEFOG is working.

Temperature Sensors

Sunload: This sensor is on top of the instrument panel. When the inside temperature is increased by sunlight, the system will lower the inside temperature up to 5°F (3°C) below the setting on the display.

Outside Temperature: This sensor is on the right side of the upper radiator support in the grille opening. This is what you usually see on the display.

If the outside temperature goes up, the displayed temperature will not change until:

- Vehicle speed is above 25 mph (40 km/h) for at least three minutes, or
- Vehicle speed is above 45 mph (72 km/h) for one and a half minutes.

This delay helps prevent a false reading. If vehicle speed remains above 25 mph (40 km/h) or the temperature goes down, the display is updated immediately.

If your vehicle has been off for more than three hours, the current outside temperature will be stored in the system when you start the vehicle.

Inside Temperature: This sensor is in the center air outlet on the passenger side.

If you block or cover either interior sensor (sunload or the inside temperature), the system will give a false reading.

Automatic Control

The system will adjust to maintain the temperature you set. It will select the best fan speed and airflow setting to keep you comfortable with the least amount of noise.

Press the arrows on the TEMP SET switch to set a comfortable temperature. Then press AUTO and the fan speed will adjust automatically unless you press the arrows on the AUTO switch.

Manual Heating

The heater works best if you keep your windows closed while using it.

Press the arrows on the TEMP SET switch to set a comfortable temperature. Then press HEATER and, if you don't like the automatic setting, press the arrows on the fan speed switch. In AUTO FAN on cold days, the fan will stay off until the coolant warms up enough to heat your vehicle.

If your vehicle has an engine coolant heater and you use it in cold weather, 0°F (-18°C) or lower, your heating system can provide heat more quickly because the engine coolant is already warmed. See "Engine Coolant Heater" in the Index.

Manual Bi-Level

BI-LEVEL can heat or cool outside air and direct it in two directions.

Press the arrows on the TEMP SET switch to set a comfortable temperature. Press BI-LEVEL and, if you don't like the automatic setting, press the arrows on the fan speed switch.

Manual Ventilation

For mild outside temperatures, when little heating or cooling is needed, you can still direct outside air through your vehicle.

Press the arrows on the TEMP SET switch to set a comfortable temperature. For ventilation, the system can't cool the vehicle below the outside temperature.

Press VENT and, if you don't like the automatic setting, press the arrows on the fan speed switch.

Manual Cooling

The air conditioner works best if you keep your windows closed. On very hot days, open the windows just long enough for the hot air to escape.

Press the arrows on the TEMP SET switch to set a comfortable temperature. Press RECIRCULATE. After cool-down, adjust the airflow to another setting. The compressor works in all settings except VENT and HEATER, and at all temperatures above freezing.

Press the arrows on the fan speed switch if you don't like the automatic setting. In AUTO FAN on hot days, the fan speed will be low at first to help get rid of the hot inside air.

When the air conditioner is on, you may notice slight changes in your vehicle's engine speed and power. This is normal because the system is designed to cycle the compressor on and off to keep the desired temperature and help fuel economy.

Defogging and Defrosting

Your vehicle has several settings for clearing your windows. The air conditioning compressor will run to help remove moisture from the air.

To defrost the windshield quickly, press the arrows on the TEMP SET switch to set a comfortable temperature. Press DEFROST and the fan will go to high speed. After the windows are clear, you can lower the speed using the downward arrow or AUTO FAN.

With the automatic system, to warm passengers while keeping the windshield clear, press the arrows on the TEMP SET switch to set a comfortable temperature. Press HEATER and DEFROST at the same time and, if you don't like the automatic setting, press the arrows on the fan speed switch.

To defrost the side windows quickly, press the arrows on the TEMP SET switch to set a comfortable temperature. Then press DEFROST and, if you don't like the automatic setting, press the arrows on the fan speed switch.

System Problems

If the light above an air control button flashes when you turn on the ignition, your system may have an electrical problem. The flashing will continue for one minute, then stop.

The flashing light could also mean the refrigerant level is too low in your system. The light will continue to flash, even if refrigerant is added, until the system is reset. Have your system checked and serviced if needed.

To reset your system:

1. Turn your ignition key to OFF or LOCK.
2. Remove the courtesy lamps and radio fuses from the main fuse panel and wait one minute. See "Fuses and Circuit Breakers" in the Index.
3. Put the fuses back in and start your vehicle.

The light shouldn't come on and your system should be working properly. If you still have a problem, see your dealer.

Rear Window Defogger

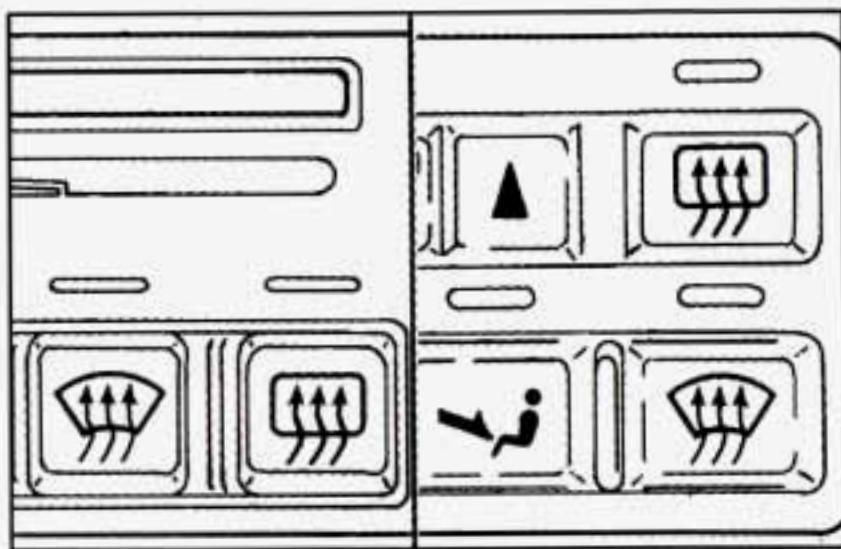

The rear window defogger uses a warming grid to remove fog from the rear window. The power mirrors are also warmed when the rear window defogger is on.

Press the button with the defog symbol on it to turn on the defogger. (The button is at the lower right on the manual system and at the upper right on the automatic system.) An indicator light will come on to remind you that the defogger is on. The defogger will turn off automatically after about 10 minutes of use. You can also turn the defogger off by pressing the switch again or by turning off the ignition.

Do not attach anything like a temporary vehicle license or a decal across the defogger grid on the rear window.

NOTICE:

Don't use a razor blade or something else sharp on the inside of the rear window. If you do, you could cut or damage the warming grid, and the repairs wouldn't be covered by your warranty.

Ventilation System



Adjust the direction of airflow by moving the louvered vents.

Your Corvette's flow-through ventilation system supplies outside air into the vehicle when it is moving. Outside air will also enter the vehicle when the heater or the air conditioning fan is running.

Ventilation Tips

- Keep the hood and front air inlet free of ice, snow or any other obstruction (such as leaves). The heater and defroster will work far better, reducing the chance of fogging the inside of your windows.
- When you enter a vehicle in cold weather, adjust the fan to the highest speed for a few moments before driving off. This helps clear the intake ducts of snow and moisture, and reduces the chance of fogging the inside of your windows.
- Keep the air path under the front seats clear of objects. This helps air to circulate throughout your vehicle.

Audio Systems

Your Delco[®] audio system has been designed to operate easily and give years of listening pleasure. You will get the most enjoyment out of it if you acquaint yourself with it first. Find out what your Delco system can do and how to operate all its controls, to be sure you're getting the most out of the advanced engineering that went into it.

Setting the Clock

Make sure the radio is off and then press SET. Within five seconds, press and hold the down arrow until the correct hour appears. Press and hold the up arrow until the correct minute appears.

Noise Reduction

Your audio system has automatic Dolby[®] B Noise Reduction.

Dolby Noise Reduction is manufactured under a license from Dolby Laboratories Licensing Corporation. Dolby and the double-D symbol are trademarks of Dolby Laboratories Licensing Corporation.

AM-FM Stereo with Cassette Tape Player



Playing the Radio

VOL-PROG-RCL: Turn the upper knob to turn the system on or off, and to adjust the volume. Press the knob to recall the station being played or to display the clock.

Finding a Station

AM-FM: Press this button to get AM or FM. The lighted display shows your selection.

TUNE: Press the up or down arrow to choose radio stations. For fast tuning, press and hold one side of the button, then press the other side.

AUTO: Press this button and then the up or down arrow and the radio will tune to the next higher or lower station and stay there.

PUSHBUTTONS: The six numbered pushbuttons let you return to your previously played stations. You can set up to 12 stations (six AM and six FM).

1. Tune in the desired station.
2. Press SET.
3. Press one of the six pushbuttons within five seconds. Whenever you press that numbered button, the station you set will return.
4. Repeat the steps for each pushbutton.

Setting the Tone

BASS: Turn this knob to the right to hear more bass.

TREB: Turn this control behind the BASS knob to the right to hear more treble.

Adjusting the Speakers

BAL: Turn the control behind the FADE knob to move the sound between the right and left speakers.

FADE: Turn this knob to move the sound between the front and rear speakers. Turn it counterclockwise to hear more sound from the front speakers and clockwise to hear more sound from the rear speakers. Note that if you turn the knob all the way to F or R, you may still get some sound from the opposite speakers.

Playing a Cassette Tape

Your tape player is built to work best with tapes that are 30 to 45 minutes long on each side. Tapes longer than that are so thin they may not work well in this player.

The longer side with the tape visible goes in first. If you hear nothing or hear just a garbled sound, it may not be in squarely. Press EJCT to remove the tape and start over.

Once the tape is playing, use the knobs for VOL, FADE and BAL, just as you do for the radio.

REV: Press this button to return to a previously played passage rapidly. Press it again to play the passage. The radio will play while the tape is rewinding.

FF: Press this button to fast forward or advance the tape rapidly. Press it again to play. The radio will play while the tape is advancing.

REPT: Press this button to go to the beginning of the current selection after 10 seconds or more of play. After five seconds or less of play, the player will return to the beginning of the previous selection.

SRCH: Press this button to go to the beginning of the next selection.

SCAN: Press this button to listen to the first eight seconds of each passage. Press it again to stop scanning.

PROG-RCL: Press the upper knob to change the side of the tape that is playing. The lighted arrows show which side is currently playing.

EJCT: Press this button to remove the tape.

STOP-PLAY: Press this button to listen to the radio without ejecting the cassette tape. Press it again to go back to the tape.

CrO₂: Press this button when playing high-bias chrome or metal tapes.

Delco-Bose® AM-FM Stereo with Cassette Tape Player (Option)



Playing the Radio

VOL-PROG-RCL: Turn the upper knob to turn the system on or off, and to adjust the volume. Press the knob to recall the station being played or to display the clock and to change tape direction when a tape is inserted.

Finding a Station

AM-FM: Press this button to get AM or FM. The lighted display shows your selection.

TUNE: Press the up or down arrow to choose radio stations. For fast tuning, press and hold one side of the button, then press the other side.

AUTO: Press this button and then the up or down TUNE arrow and the radio will tune to the next higher or lower station and stay there.

PUSHBUTTONS: The six numbered pushbuttons let you return to your previously played stations. You can set up to 12 stations (six AM and six FM).

1. Tune in the desired station.
2. Press SET.
3. Press one of the six pushbuttons within five seconds. Whenever you press that numbered button, the station you set will return.
4. Repeat the steps for each pushbutton.

Setting the Tone

BASS: Turn this knob to the right to hear more bass.

TREB: Turn this control behind the BASS knob to the right to hear more treble.

Adjusting the Speakers

BAL: With the Delco/Bose system, your speakers are electronically balanced.

FADE: Turn this knob to move the sound between the front and rear speakers. Note that, with the Delco/Bose system, if you turn the knob all the way to F or R, you may still get some sound from the opposite speakers.

Playing a Cassette Tape

Your tape player is built to work best with tapes that are 30 to 45 minutes long on each side. Tapes longer than that are so thin they may not work well in this player.

The longer side with the tape visible goes in first. If you hear nothing or hear just a garbled sound, it may not be in squarely. Press EJCT to remove the tape and start over.

Once the tape is playing, use the knobs for VOL, FADE and BAL, just as you do for the radio.

REV: Press this button to return to a previously played passage rapidly. Press it again to play the passage. The radio will play while the tape is rewinding.

FF: Press this button to fast forward or advance the tape rapidly. Press it again to play the passage. The radio will play while the tape is advancing.

REPT: Press this button to go to the beginning of the current selection after 10 seconds or more of play. After five seconds or less of play, the player will return to the beginning of the previous selection.

SRCH: Press this button to go to the beginning of the next selection.

SCAN: Press this button to listen to the first eight seconds of each passage. Press it again to stop scanning.

PROG-RCL: Press the upper knob to change the side of the tape that is playing. The lighted arrows show which side is currently playing.

EJCT: Press this button to remove the tape.

STOP-PLAY: Press this button to listen to the radio without ejecting the cassette tape. Press it again to go back to the tape.

CrO₂: Press this button when playing high-bias chrome or metal tapes.

Delco-Bose AM-FM Stereo with Cassette Tape and Compact Disc Players (Option)



Playing the Radio

VOL-PROG-RCL: Turn the upper knob to turn the system on or off, and to adjust the volume. Press the knob to recall the station being played or to display the clock.

Your system also has a feature called Speed-Compensated-Volume (SCV). With SCV, your audio system makes up for road noise by getting louder as you drive faster. The control behind the upper knob

has three SCV positions. H has a higher maximum volume and gets louder faster than L. Use H when you are driving with the roof panel off, the convertible top down or the windows open. If you don't want to use SCV, turn the control to OFF.

Finding a Station

AM-FM: Press this button to get AM or FM. The lighted display shows your selection.

TUNE: Press the up and down arrows to choose radio stations. For fast tuning, press and hold one side of the button, then press the other side.

AUTO: Press this button and then the up or down TUNE arrow and the radio will tune to the next higher or lower station and stay there.

PUSHBUTTONS: The six numbered pushbuttons let you return to your previously played stations. You can set up to 12 stations (six AM and six FM).

1. Tune in the desired station.
2. Press SET.
3. Press one of the six pushbuttons within five seconds. Whenever you press that numbered button, the station you set will return.
4. Repeat the steps for each pushbutton.

Setting the Tone

BASS: Turn this knob to the right to hear more bass.

TREB: Turn this control behind the BASS knob to the right to hear more treble.

Adjusting the Speakers

BAL: With the Delco/Bose system, your speakers are electronically balanced.

FADE: Turn this knob to move the sound between the front and rear speakers. Note that if you turn the knob all the way to F or R, you may still get some sound from the opposite speakers.

Playing a Cassette Tape

Your tape player is built to work best with tapes that are 30 to 45 minutes long on each side. Tapes longer than that are so thin they may not work well in this player.

The longer side with the tape visible goes in first. If you hear nothing or hear just a garbled sound, it may not be in squarely. Press EJCT to remove the tape and start over.

Once the tape is playing, use the knobs for VOL, FADE and BAL, just as you do for the radio.

REV: Press this button to return to a previously played passage rapidly. Press it again to play the passage. The radio will play while the tape is rewinding.

FF: Press this button to fast forward or advance the tape rapidly. Press it again to play. The radio will play while the tape is advancing.

REPT: Press this button to go to the beginning of the current selection after 10 seconds or more of play. After five seconds or less of play, the player will return to the beginning of the previous selection.

SRCH: Press this button to go to the beginning of the next selection.

SCAN: Press this button to listen to the first eight seconds of each passage. Press it again to stop scanning.

PROG-RCL: Press the upper knob to change the side of the tape that is playing. The lighted arrows show which side is currently playing.

EJCT: Press this button to remove the tape.

STOP-PLAY: Press this button to listen to the radio without ejecting the cassette tape. Press it again to go back to the tape.

CrO₂: Press this button when playing high-bias chrome or metal tapes.

Playing a Compact Disc

Don't use the mini-discs (three-inch singles). They will eject, and they won't play. Use only full-size compact discs.

With the audio system on, insert a disc into the slot with the label side up. CD will appear on the display and track one will begin to play. If both a tape and a compact disc are loaded into the system, press CA/CD to select the one you want.

If the disc comes back out and ERR appears on the display, it could be that:

- The disc is upside down.
- It is dirty, scratched or wet.
- There's too much moisture in the air. (Wait about an hour and try again.)
- You are driving on a very rough road.
- The temperature is too hot or too cold.

RCL: Press this button to see what track is playing. Press it again within five seconds to see how long it has been playing, the elapsed time (EL TIME).

REV: Press and hold this button to return to a previously played passage rapidly. The decreasing elapsed time will show on the display.

FF: Press and hold this button to fast forward or advance through passages. The increasing elapsed time will show on the display.

REPT: Press this button to go to the beginning of the current track after eight seconds or more of play. After eight seconds or less of play, the player will return to the beginning of the previous track.

SRCH: Press this button to go to the beginning of the next track.

SCAN: Press this button to listen to the first eight seconds of each track. Press it again to stop scanning.

COMP: Press this button to make loud and soft passages more nearly equal in volume. Press it again for normal play.

Stopping the Disc Player

- Turn the power off or turn the ignition key to off. The disc stays in the player and will resume playing at the point where it stopped when the ignition is turned on.
- Press STOP-PLAY to stop playing the disc and switch to the radio. Press it again to restart the disc at the point where it stopped.
- Press EJCT to eject the disc and switch to the radio. If the ignition or audio system is turned off, the player will pull the disc back in if you don't remove it from the opening within 30 seconds.

Understanding Radio Reception

FM Stereo

FM stereo will give you the best sound. But FM signals will reach only about 10 to 40 miles (16 to 65 km). Tall buildings or hills can interfere with FM signals, causing the sound to come and go.

AM

The range for most AM stations is greater than for FM, especially at night. The longer range, however, can cause stations to interfere with each other. AM can pick up noise from things like storms and power lines. Try reducing the treble to reduce this noise if you ever get it.

Tips About Your Audio System

Hearing damage from loud noise is almost undetectable until it is too late. Your hearing can adapt to higher volumes of sound. Sound that seems normal can be loud and harmful to your hearing. Take precautions by adjusting the volume control on your radio to a safe sound level before your hearing adapts to it.

To help avoid hearing loss or damage:

- Adjust the volume control to the lowest setting.
- Increase volume slowly until you hear comfortably and clearly.

NOTICE:

Before you add any sound equipment to your vehicle -- like a tape player, CB radio, mobile telephone or two-way radio -- be sure you can add what you want. If you can, it's very important to do it properly. Added sound equipment may interfere with the operation of your vehicle's engine, Delco radio or other systems, and even damage them. Your vehicle's systems may interfere with the operation of sound equipment that has been added improperly.

So, before adding sound equipment, check with your dealer and be sure to check Federal rules covering mobile radio and telephone units.

Care of Your Cassette Tape Player

A tape player that is not cleaned regularly can cause reduced sound quality, ruined cassettes or a damaged mechanism. Cassette tapes should be stored in their cases away from contaminants, direct sunlight and extreme heat. If they aren't, they may not operate properly or may cause failure of the tape player.

Your tape player should be cleaned regularly after every 50 hours of use. If you notice a reduction in sound quality, try a known good cassette to see if the tape or the tape player is at fault. If this other cassette has no improvement in sound quality, clean the tape player.

Cleaning may be done with a scrubbing action, non-abrasive cleaning cassette with pads which scrub the tape head as the hubs of the cleaner cassette turn. It is normal for the cassette to eject while cleaning. Insert the cassette at least three times to ensure thorough cleaning. A scrubbing action cleaning cassette is available through your Corvette dealer.

You may also choose a non-scrubbing action, wet-type cleaner which uses a cassette with a fabric belt to clean the tape head. This type of cleaning cassette will not eject. It may not clean as thoroughly as the scrubbing type cleaner.

Cassettes are subject to wear and the sound quality may degrade over time. Always make sure that the cassette tape is in good condition before you have your tape player serviced.

Care of Your Compact Discs

Handle discs carefully. Store them in their original cases or other protective cases and away from direct sunlight and dust. If the surface of a disc is soiled, dampen a clean, soft cloth in a mild, neutral detergent solution and clean it, wiping from the center to the edge.

Be sure never to touch the signal surface when handling discs. Pick up discs by grasping the outer edges or the edge of the hole and the outer edge.

Power Antenna Mast Care

Your power antenna will look its best and work well if it's cleaned from time to time. To clean the antenna mast:

1. Turn on the ignition and radio to raise the antenna.
2. Dampen a clean cloth with mineral spirits or equivalent solvent.
3. Wipe the cloth over the mast sections, removing any dirt.
4. Wipe dry with a clean cloth.
5. Make the antenna go up and down by turning the radio or ignition off and on.
6. Repeat if necessary.

NOTICE:

Don't lubricate the power antenna. Lubrication could damage it.

NOTICE:

Before entering an automatic car wash, turn off your radio to make the power antenna go down. This will prevent the mast from possibly getting damaged. If the antenna does not go down when you turn the radio off, it may be damaged or need to be cleaned. In either case, lower the antenna by hand by carefully pressing the antenna down.

If the mast portion of your antenna is damaged, you can easily replace it. See your dealer for a replacement kit and follow the instructions in the kit.



Section 4 Your Driving and the Road



Here you'll find information about driving on different kinds of roads and in varying weather conditions. We've also included many other useful tips on driving.

Defensive Driving

The best advice anyone can give about driving is: Drive defensively.

Please start with a very important safety device in your Corvette: Buckle up. (See "Safety Belts" in the Index.)

Defensive driving really means "be ready for anything." On city streets, rural roads or freeways, it means "always expect the unexpected."

Assume that pedestrians or other drivers are going to be careless and make mistakes. Anticipate what they might do. Be ready for their mistakes.

Rear-end collisions are about the most preventable of accidents. Yet they are common. Allow enough following distance. It's the best defensive driving maneuver, in both city and rural driving. You never know when the vehicle in front of you is going to brake or turn suddenly.

Drunken Driving

Death and injury associated with drinking and driving is a national tragedy. It's the number one contributor to the highway death toll, claiming thousands of victims every year.

Alcohol affects four things that anyone needs to drive a vehicle:

- Judgment
- Muscular Coordination
- Vision
- Attentiveness.

Police records show that almost half of all motor vehicle-related deaths involve alcohol. In most cases, these deaths are the result of someone who was drinking and driving. In recent years, some 18,000 annual motor vehicle-related deaths have been associated with the use of alcohol, with more than 300,000 people injured.

Many adults -- by some estimates, nearly half the adult population -- choose never to drink alcohol, so they never drive after drinking. For persons under 21, it's against the law in every U.S. state to drink alcohol. There are good medical, psychological and developmental reasons for these laws.

The obvious way to solve this highway safety problem is for people never to drink alcohol and then drive. But what if people do? How much is "too much" if the driver plans to drive? It's a lot less than many might think. Although it depends on each person and situation, here is some general information on the problem.

The Blood Alcohol Concentration (BAC) of someone who is drinking depends upon four things:

- The amount of alcohol consumed
- The drinker's body weight
- The amount of food that is consumed before and during drinking
- The length of time it has taken the drinker to consume the alcohol.

According to the American Medical Association, a 180-lb. (82 kg) person who drinks three 12-ounce (355 ml) bottles of beer in an hour will end up with a BAC of about 0.06 percent. The person would reach the same BAC by drinking three 4-ounce (120 ml) glasses of wine or three mixed drinks if each had 1-1/2 ounces (45 ml) of a liquor like whiskey, gin or vodka.



It's the amount of alcohol that counts. For example, if the same person drank three double martinis (3 ounces or 90 ml of liquor each) within an hour, the person's BAC would be close to 0.12 percent. A person who consumes food just before or during drinking will have a somewhat lower BAC level.

There is a gender difference, too. Women generally have a lower relative percentage of body water than men.

Since alcohol is carried in body water, this means that a woman generally will reach a higher BAC level than a man of her same body weight when each has the same number of drinks.

The law in many U.S. states sets the legal limit at a BAC of 0.10 percent. In a growing number of U.S. states, and throughout Canada, the limit is 0.08 percent. In some other countries, it's even lower. The BAC limit for all commercial drivers in the United States is 0.04 percent.

The BAC will be over 0.10 percent after three to six drinks (in one hour). Of course, as we've seen, it depends on how much alcohol is in the drinks, and how quickly the person drinks them.

But the ability to drive is affected well below a BAC of 0.10 percent. Research shows that the driving skills of many people are impaired at a BAC approaching 0.05 percent, and that the effects are worse at night. All drivers are impaired at BAC levels above 0.05 percent. Statistics show that the chance of being in a collision increases sharply for drivers who have a BAC of 0.05 percent or above. A driver with a BAC level of 0.06 percent has doubled his or her chance of having a collision. At a BAC level of 0.10 percent, the chance of this driver having a collision is 12 times greater; at a level of 0.15 percent, the chance is 25 times greater!

The body takes about an hour to rid itself of the alcohol in one drink. No amount of coffee or number of cold showers will speed that up. "I'll be careful" isn't the right answer. What if there's an emergency, a need to take sudden action, as when a child darts into the street? A person with even a moderate BAC might not be able to react quickly enough to avoid the collision.

There's something else about drinking and driving that many people don't know. Medical research shows that alcohol in a person's system can make crash injuries worse, especially injuries to the brain, spinal cord or heart. This means that when anyone who has been drinking -- driver or passenger -- is in a crash, that person's chance of being killed or permanently disabled is higher than if the person had not been drinking.

 **CAUTION:**

Drinking and then driving is very dangerous. Your reflexes, perceptions, attentiveness and judgment can be affected by even a small amount of alcohol. You can have a serious -- or even fatal -- collision if you drive after drinking. Please don't drink and drive or ride with a driver who has been drinking. Ride home in a cab; or if you're with a group, designate a driver who will not drink.

Control of a Vehicle

You have three systems that make your vehicle go where you want it to go. They are the brakes, the steering and the accelerator. All three systems have to do their work at the places where the tires meet the road.

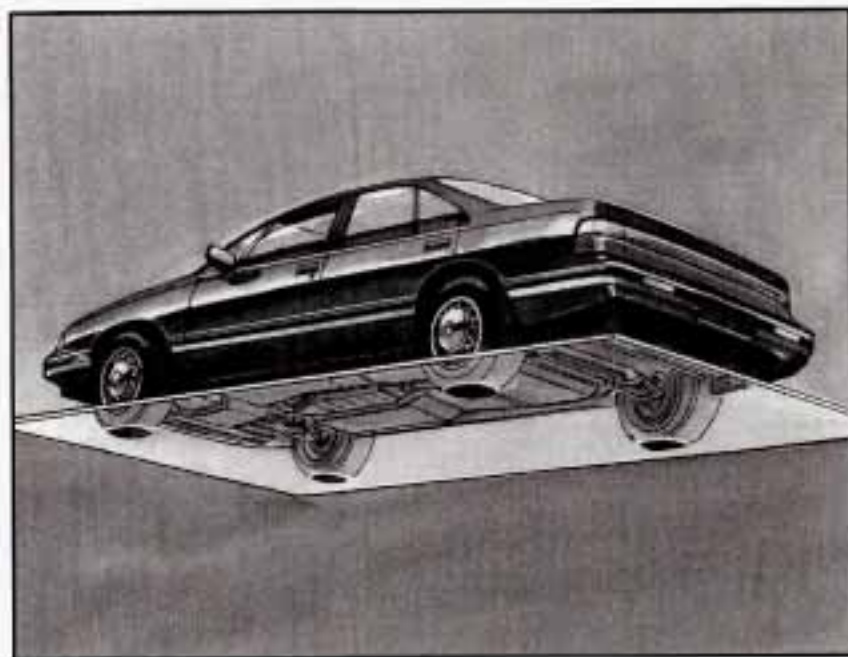

Sometimes, as when you're driving on snow or ice, it's easy to ask more of those control systems than the tires and road can provide. That means you can lose control of your vehicle.

Braking

Braking action involves *perception time* and *reaction time*.

First, you have to decide to push on the brake pedal. That's *perception time*. Then you have to bring up your foot and do it. That's *reaction time*.

Average *reaction time* is about $\frac{3}{4}$ of a second. But that's only an average. It might be less with one driver and as long as two or three seconds or more with another. Age, physical condition, alertness, coordination and eyesight all play a part. So do alcohol, drugs and frustration. But even in $\frac{3}{4}$ of a second, a vehicle moving at 60 mph (100 km/h) travels 66 feet (20 m). That could be a lot of distance in an emergency, so keeping enough space between your vehicle and others is important.

And, of course, actual stopping distances vary greatly with the surface of the road (whether it's pavement or gravel); the condition of the road (wet, dry, icy); tire tread; and the condition of your brakes.

Avoid needless heavy braking. Some people drive in spurts -- heavy acceleration followed by heavy braking -- rather than keeping pace with traffic. This is a mistake. Your brakes may not have time to cool between hard stops. Your brakes will wear out much faster if you do a lot of heavy braking. If you keep pace with the traffic and allow realistic following distances, you will eliminate a lot of unnecessary braking. That means better braking and longer brake life.

If your engine ever stops while you're driving, brake normally but don't pump your brakes. If you do, the pedal may get harder to push down. If your engine stops, you will still have some power brake assist. But you will use it when you brake. Once the power assist is used up, it may take longer to stop and the brake pedal will be harder to push.

Anti-Lock Brakes

Your vehicle has anti-lock brakes (ABS). ABS is an advanced electronic braking system that will help prevent a braking skid.

When you start your engine and begin to drive away, your anti-lock brake system will check itself. You may hear a momentary motor or clicking noise while this test is going on, and you may even notice that your brake pedal moves a little. This is normal.

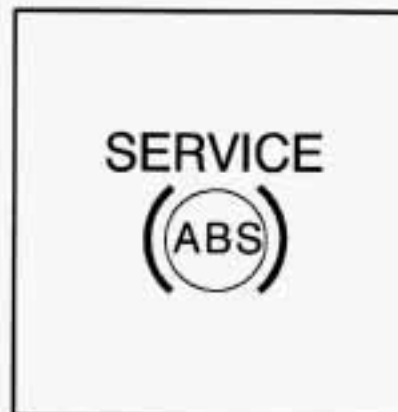

If there's a problem with the anti-lock brake system, this warning light will stay on. See "Anti-Lock Brake System Warning Light" in the Index.



Here's how anti-lock works. Let's say the road is wet. You're driving safely. Suddenly an animal jumps out in front of you.

You slam on the brakes. Here's what happens with ABS.

A computer senses that wheels are slowing down. If one of the wheels is about to stop rolling, the computer will separately work the brakes at each front wheel and at the rear wheels.

The anti-lock system can change the brake pressure faster than any driver could. The computer is programmed to make the most of available tire and road conditions.



You can steer around the obstacle while braking hard.

As you brake, your computer keeps receiving updates on wheel speed and controls braking pressure accordingly.

Remember: Anti-lock doesn't change the time you need to get your foot up to the brake pedal or always decrease stopping distance. If you get too close to the vehicle in front of you, you won't have time to apply your brakes if that vehicle suddenly slows or stops. Always leave enough room up ahead to stop, even though you have anti-lock brakes.

Using Anti-Lock

Don't pump the brakes. Just hold the brake pedal down and let anti-lock work for you. You may hear a motor or clicking noise and feel the brake pedal move a little during a stop, but this is normal.

A rectangular box containing the text "ABS ACTIVE" in bold, black, sans-serif font, centered within the box.

**ABS
ACTIVE**

When your anti-lock system is adjusting brake pressure to help avoid a braking skid, this light will come on. See "Anti-Lock Brake System Active Light" in the Index.

ASR (Acceleration Slip Regulation) System

Your vehicle has a traction control system called ASR that limits wheel spin. This is especially useful in slippery road conditions. The system operates only if it senses that the rear wheels are spinning too much or are beginning to lose traction. When this happens, the system works the rear brakes and reduces engine power (by closing the throttle and managing engine spark) to limit wheel spin.

A rectangular box containing the text "ASR ACTIVE" in bold, black, sans-serif font, centered within the box.

**ASR
ACTIVE**

This light will come on when the ASR system is limiting wheel spin. See "ASR System Active Light" in the Index. You may feel or hear the system working, but this is normal.

If your vehicle is in cruise control when the ASR system begins to limit wheel spin, the cruise control will automatically disengage. When road conditions allow you to safely use it again, you may re-engage the cruise control. (See "Cruise Control" in the Index.)

SERVICE ASR

This warning light will come on to let you know if there's a problem with your ASR system. See "ASR System Warning Light" in the Index.

When this warning light is on, the system will not limit wheel spin. Adjust your driving accordingly. (The ASR OFF light will also come on when the ASR system warning light comes on.)

The ASR system automatically comes on whenever you start your vehicle. To limit wheel spin, especially in slippery road conditions, you should always leave the system on. But you can turn the ASR system off if you ever need to. (You should turn the system off if your vehicle ever gets stuck in sand, mud, ice or snow. See "Rocking Your Vehicle" in the Index.)

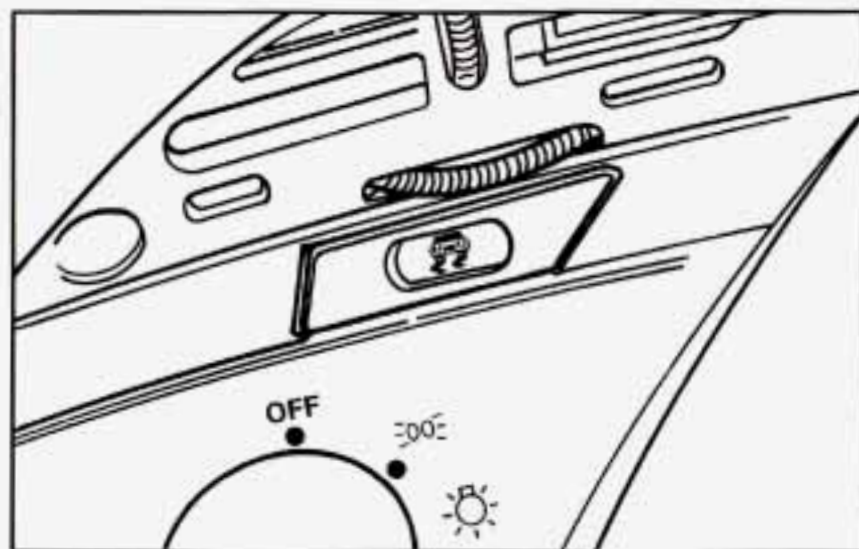

To turn the system off, press the button located above the headlamp switch. The ASR OFF light will come on and stay on. If the ASR system is limiting wheel spin when you press the button, the system will turn off right away.

You can turn the system back on at any time by pressing the button again. The ASR OFF light should go off.

Braking in Emergencies

Use your anti-lock braking system when you need to. With anti-lock, you can steer and brake at the same time. In many emergencies, steering can help you more than even the very best braking.

Steering

Power Steering

If you lose power steering assist because the engine stops or the system is not functioning, you can steer but it will take much more effort.

Steering Tips

Driving on Curves

It's important to take curves at a reasonable speed.

A lot of the "driver lost control" accidents mentioned on the news happen on curves. Here's why:

Experienced driver or beginner, each of us is subject to the same laws of physics when driving on curves. The traction of the tires against the road surface makes it possible for the vehicle to change its path when you turn the front wheels. If there's no traction, inertia will keep the vehicle going in the same direction. If you've ever tried to steer a vehicle on wet ice, you'll understand this.

The traction you can get in a curve depends on the condition of your tires and the road surface, the angle at which the curve is banked, and your speed. While you're in a curve, speed is the one factor you can control.

Suppose you're steering through a sharp curve. Then you suddenly accelerate. Both control systems -- steering and acceleration -- have to do their work where the tires meet the road. Unless your ASR system is on, adding the sudden acceleration can demand too much of those places. You can lose control.

What should you do if this ever happens? Ease up on the accelerator pedal, steer the vehicle the way you want it to go, and slow down.

Speed limit signs near curves warn that you should adjust your speed. Of course, the posted speeds are based on good weather and road conditions. Under less favorable conditions you'll want to go slower.

If you need to reduce your speed as you approach a curve, do it before you enter the curve, while your front wheels are straight ahead.

Try to adjust your speed so you can "drive" through the curve. Maintain a reasonable, steady speed. Wait to accelerate until you are out of the curve, and then accelerate gently into the straightaway.

Steering in Emergencies

There are times when steering can be more effective than braking. For example, you come over a hill and find a truck stopped in your lane, or a car suddenly pulls out from nowhere, or a child darts out from between parked cars and stops right in front of you. You can avoid these problems by braking -- if you can stop in time. But sometimes you can't; there isn't room. That's the time for evasive action -- steering around the problem.

Your Corvette can perform very well in emergencies like these. First apply your brakes. (See "Braking in Emergencies" earlier in this section.) It is better to remove as much speed as you can from a possible collision. Then steer around the problem, to the left or right depending on the space available.



An emergency like this requires close attention and a quick decision. If you are holding the steering wheel at the recommended 9 and 3 o'clock positions, you can turn it a full 180 degrees very quickly without removing either hand. But you have to act fast, steer quickly, and just as quickly straighten the wheel once you have avoided the object.

The fact that such emergency situations are always possible is a good reason to practice defensive driving at all times and wear safety belts properly.

Off-Road Recovery

You may find sometime that your right wheels have dropped off the edge of a road onto the shoulder while you're driving.

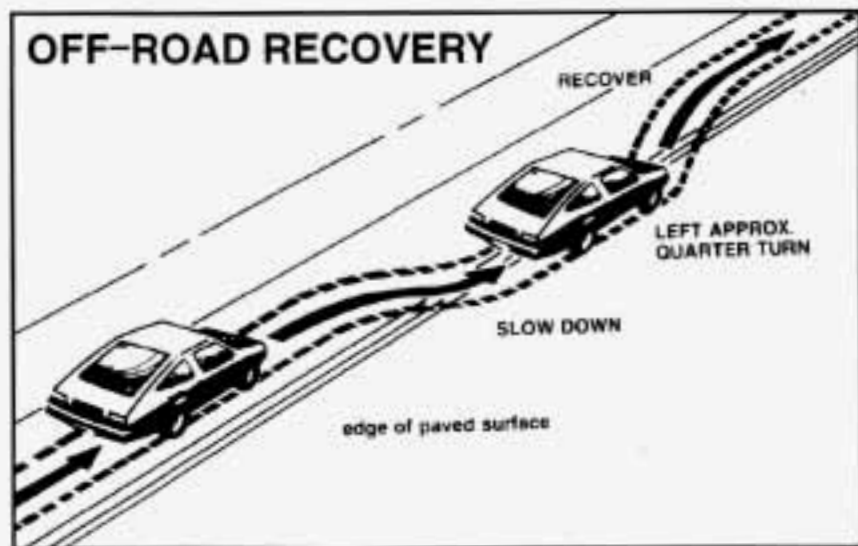

If the level of the shoulder is only slightly below the pavement, recovery should be fairly easy. Ease off the accelerator and then, if there is nothing in the way, steer so that your vehicle straddles the edge of the pavement. You can turn the steering wheel up to one-quarter turn until the right front tire contacts the pavement edge. Then turn your steering wheel to go straight down the roadway.

Passing

The driver of a vehicle about to pass another on a two-lane highway waits for just the right moment, accelerates, moves around the vehicle ahead, then goes back into the right lane again. A simple maneuver?

Not necessarily! Passing another vehicle on a two-lane highway is a potentially dangerous move, since the passing vehicle occupies the same lane as oncoming traffic for several seconds. A miscalculation, an error in judgment, or a brief surrender to frustration or anger can suddenly put the passing driver face to face with the worst of all traffic accidents -- the head-on collision.

So here are some tips for passing:

- "Drive ahead." Look down the road, to the sides and to crossroads for situations that might affect your passing patterns. If you have any doubt whatsoever about making a successful pass, wait for a better time.
- Watch for traffic signs, pavement markings and lines. If you can see a sign up ahead that might indicate a turn or an intersection, delay your pass. A broken center line usually indicates it's all right to pass (providing the road ahead is clear). Never cross a solid line on your side of the lane or a double solid line, even if the road seems empty of approaching traffic.

- Do not get too close to the vehicle you want to pass while you're awaiting an opportunity. For one thing, following too closely reduces your area of vision, especially if you're following a larger vehicle. Also, you won't have adequate space if the vehicle ahead suddenly slows or stops. Keep back a reasonable distance.
- When it looks like a chance to pass is coming up, start to accelerate but stay in the right lane and don't get too close. Time your move so you will be increasing speed as the time comes to move into the other lane. If the way is clear to pass, you will have a "running start" that more than makes up for the distance you would lose by dropping back. And if something happens to cause you to cancel your pass, you need only slow down and drop back again and wait for another opportunity.
- If other cars are lined up to pass a slow vehicle, wait your turn. But take care that someone isn't trying to pass you as you pull out to pass the slow vehicle. Remember to glance over your shoulder and check the blind spot.
- Check your mirrors, glance over your shoulder, and start your left lane change signal before moving out of the right lane to pass. When you are far enough ahead of the passed vehicle to see its front in your inside mirror, activate your right lane change signal and move back into the right lane. (Remember that your right outside mirror is convex. The vehicle you just passed may seem to be farther away from you than it really is.)
- Try not to pass more than one vehicle at a time on two-lane roads. Reconsider before passing the next vehicle.
- Don't overtake a slowly moving vehicle too rapidly. Even though the brake lamps are not flashing, it may be slowing down or starting to turn.
- If you're being passed, make it easy for the following driver to get ahead of you. Perhaps you can ease a little to the right.

Loss of Control

Let's review what driving experts say about what happens when the three control systems (brakes, steering and acceleration) don't have enough friction where the tires meet the road to do what the driver has asked.

In any emergency, don't give up. Keep trying to steer and constantly seek an escape route or area of less danger.

Skidding

In a skid, a driver can lose control of the vehicle. Defensive drivers avoid most skids by taking reasonable care suited to existing conditions, and by not "overdriving" those conditions. But skids are always possible.

The three types of skids correspond to your Corvette's three control systems. In the braking skid, your wheels aren't rolling. In the steering or cornering skid, too much speed or steering in a curve causes tires to slip and lose cornering force. And in the acceleration skid, too much throttle causes the driving wheels to spin.

A cornering skid is best handled by easing your foot off the accelerator pedal.

Remember: Any ASR system helps avoid only the acceleration skid.

If your ASR system is off, then an acceleration skid is also best handled by easing your foot off the accelerator pedal.

If your vehicle starts to slide, ease your foot off the accelerator pedal and quickly steer the way you want the vehicle to go. If you start steering quickly enough, your vehicle may straighten out. Always be ready for a second skid if it occurs.

Of course, traction is reduced when water, snow, ice, gravel or other material is on the road. For safety, you'll want to slow down and adjust your driving to these conditions. It is important to slow down on slippery surfaces because stopping distance will be longer and vehicle control more limited.

While driving on a surface with reduced traction, try your best to avoid sudden steering, acceleration or braking (including engine braking by shifting to a lower gear). Any sudden changes could cause the tires to slide. You may not realize the surface is slippery until your vehicle is skidding. Learn to recognize warning clues -- such as enough water, ice or packed snow on the road to make a "mirrored surface" -- and slow down when you have any doubt.

Remember: Any anti-lock brake system (ABS) helps avoid only the braking skid.

Driving at Night

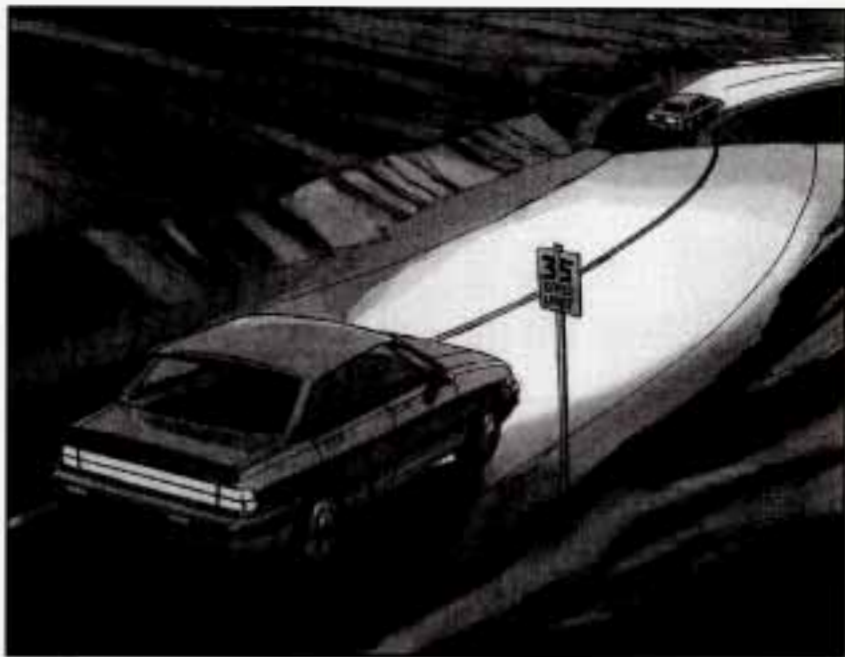

Night driving is more dangerous than day driving. One reason is that some drivers are likely to be impaired -- by alcohol or drugs, with night vision problems, or by fatigue.

Here are some tips on night driving.

- Drive defensively.
- Don't drink and drive.

- Adjust your inside rearview mirror to reduce the glare from headlamps behind you.
- Since you can't see as well, you may need to slow down and keep more space between you and other vehicles.
- Slow down, especially on higher speed roads. Your headlamps can light up only so much road ahead.
- In remote areas, watch for animals.
- If you're tired, pull off the road in a safe place and rest.

Night Vision

No one can see as well at night as in the daytime. But as we get older these differences increase. A 50-year-old driver may require at least twice as much light to see the same thing at night as a 20-year-old.

What you do in the daytime can also affect your night vision. For example, if you spend the day in bright sunshine you are wise to wear sunglasses. Your eyes will have less trouble adjusting to night. But if you're driving, don't wear sunglasses at night. They may cut down on glare from headlamps, but they also make a lot of things invisible.

You can be temporarily blinded by approaching headlamps. It can take a second or two, or even several seconds, for your eyes to readjust to the dark. When you are faced with severe glare (as from a driver who doesn't lower the high beams, or a vehicle with misaimed headlamps), slow down a little. Avoid staring directly into the approaching headlamps.

Keep your windshield and all the glass on your vehicle clean -- inside and out. Glare at night is made much worse by dirt on the glass. Even the inside of the glass can build up a film caused by dust. Dirty glass makes lights dazzle and flash more than clean glass would, making the pupils of your eyes contract repeatedly.

Remember that your headlamps light up far less of a roadway when you are in a turn or curve. Keep your eyes moving; that way, it's easier to pick out dimly lighted objects. Just as your headlamps should be checked regularly for proper aim, so should your eyes be examined regularly. Some drivers suffer from night blindness -- the inability to see in dim light -- and aren't even aware of it.

Driving in Rain and on Wet Roads



Rain and wet roads can mean driving trouble. On a wet road, you can't stop, accelerate or turn as well because your tire-to-road traction isn't as good as on dry roads. And, if your tires don't have much tread left, you'll get even less traction. It's always wise to go slower and be cautious if rain starts to fall while you are driving. The surface may get wet suddenly when your reflexes are tuned for driving on dry pavement.

The heavier the rain, the harder it is to see. Even if your windshield wiper blades are in good shape, a heavy rain can make it harder to see road signs and traffic signals, pavement markings, the edge of the road and even people walking.

It's wise to keep your windshield wiping equipment in good shape and keep your windshield washer tank filled with washer fluid. Replace your windshield wiper inserts when they show signs of streaking or missing areas on the windshield, or when strips of rubber start to separate from the inserts.



Driving too fast through large water puddles or even going through some car washes can cause problems, too. The water may affect your brakes. Try to avoid puddles. But if you can't, try to slow down before you hit them.

⚠ CAUTION:

Wet brakes can cause accidents. They won't work well in a quick stop and may cause pulling to one side. You could lose control of the vehicle.

After driving through a large puddle of water or a car wash, apply your brake pedal lightly until your brakes work normally.

Hydroplaning

Hydroplaning is dangerous. So much water can build up under your tires that they can actually ride on the water. This can happen if the road is wet enough and you're going fast enough. When your vehicle is hydroplaning, it has little or no contact with the road.

Hydroplaning doesn't happen often. But it can if your tires haven't much tread or if the pressure in one or more is low. It can happen if a lot of water is standing on the road. If you can see reflections from trees, telephone poles or other vehicles, and raindrops "dimple" the water's surface, there could be hydroplaning.

Hydroplaning usually happens at higher speeds. There just isn't a hard and fast rule about hydroplaning. The best advice is to slow down when it is raining.

Driving Through Deep Standing Water

NOTICE:

If you drive too quickly through deep puddles or standing water, water can come in through your engine's air intake and badly damage your engine. Never drive through water that is slightly lower than the underbody of your vehicle. If you can't avoid deep puddles or standing water, drive through them very slowly.

Some Other Rainy Weather Tips

- Turn on your low-beam headlamps -- not just your parking lamps -- to help make you more visible to others.
- Besides slowing down, allow some extra following distance. And be especially careful when you pass another vehicle. Allow yourself more clear room ahead, and be prepared to have your view restricted by road spray.
- Have good tires with proper tread depth. (See "Tires" in the Index.)

City Driving



One of the biggest problems with city streets is the amount of traffic on them. You'll want to watch out for what the other drivers are doing and pay attention to traffic signals.

Here are ways to increase your safety in city driving:

- Know the best way to get to where you are going. Get a city map and plan your trip into an unknown part of the city just as you would for a cross-country trip.
- Try to use the freeways that rim and crisscross most large cities. You'll save time and energy. (See the next part, "Freeway Driving.")
- Treat a green light as a warning signal. A traffic light is there because the corner is busy enough to need it. When a light turns green, and just before you start to move, check both ways for vehicles that have not cleared the intersection or may be running the red light.

Freeway Driving

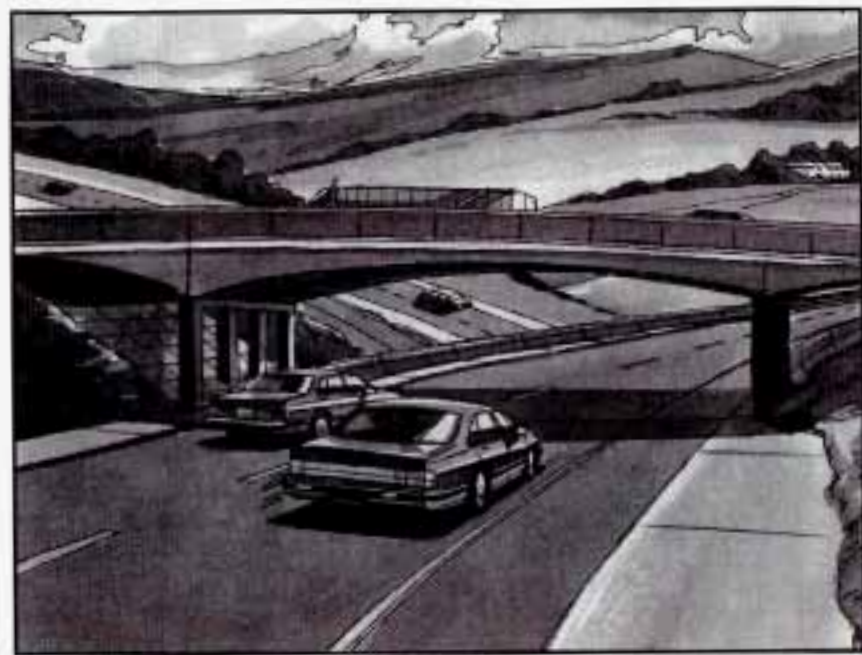

Mile for mile, freeways (also called thruways, parkways, expressways, turnpikes or superhighways) are the safest of all roads. But they have their own special rules.

The most important advice on freeway driving is: Keep up with traffic and keep to the right. Drive at the same speed most of the other drivers are driving. Too-fast or too-slow driving breaks a smooth traffic flow. Treat the left lane on a freeway as a passing lane.

At the entrance, there is usually a ramp that leads to the freeway. If you have a clear view of the freeway as you drive along the entrance ramp, you should begin to check traffic. Try to determine where you expect to blend with the flow. Try to merge into the gap at close to the prevailing speed. Switch on your turn signal, check your mirrors and glance over your shoulder as often as necessary. Try to blend smoothly with the traffic flow.

Once you are on the freeway, adjust your speed to the posted limit or to the prevailing rate if it's slower. Stay in the right lane unless you want to pass.

Before changing lanes, check your mirrors. Then use your turn signal.

Just before you leave the lane, glance quickly over your shoulder to make sure there isn't another vehicle in your "blind" spot.

Once you are moving on the freeway, make certain you allow a reasonable following distance. Expect to move slightly slower at night.

When you want to leave the freeway, move to the proper lane well in advance. If you miss your exit, do not, under any circumstances, stop and back up. Drive on to the next exit.

The exit ramp can be curved, sometimes quite sharply.

The exit speed is usually posted.

Reduce your speed according to your speedometer, not to your sense of motion. After driving for any distance at higher speeds, you may tend to think you are going slower than you actually are.

Before Leaving on a Long Trip

Make sure you're ready. Try to be well rested. If you must start when you're not fresh -- such as after a day's work -- don't plan to make too many miles that first part of the journey. Wear comfortable clothing and shoes you can easily drive in.

Is your vehicle ready for a long trip? If you keep it serviced and maintained, it's ready to go. If it needs service, have it done before starting out. Of course, you'll find experienced and able service experts in Corvette dealerships all across North America. They'll be ready and willing to help if you need it.

Here are some things you can check before a trip:

- *Windshield Washer Fluid:* Is the reservoir full? Are all windows clean inside and outside?
- *Wiper Blades:* Are they in good shape?
- *Fuel, Engine Oil, Other Fluids:* Have you checked all levels?
- *Lamps:* Are they all working? Are the lenses clean?
- *Tires:* They are vitally important to a safe, trouble-free trip. Is the tread good enough for long-distance driving? Are the tires all inflated to the recommended pressure?
- *Weather Forecasts:* What's the weather outlook along your route? Should you delay your trip a short time to avoid a major storm system?
- *Maps:* Do you have up-to-date maps?

Highway Hypnosis

Is there actually such a condition as “highway hypnosis”? Or is it just plain falling asleep at the wheel? Call it highway hypnosis, lack of awareness, or whatever.

There is something about an easy stretch of road with the same scenery, along with the hum of the tires on the road, the drone of the engine, and the rush of the wind against the vehicle that can make you sleepy. Don't let it happen to you! If it does, your vehicle can leave the road in *less than a second*, and you could crash and be injured.

What can you do about highway hypnosis? First, be aware that it can happen.

Then here are some tips:

- Make sure your vehicle is well ventilated, with a comfortably cool interior.
- Keep your eyes moving. Scan the road ahead and to the sides. Check your rearview mirrors and your instruments frequently.
- If you get sleepy, pull off the road into a rest, service or parking area and take a nap, get some exercise, or both. For safety, treat drowsiness on the highway as an emergency.

Hill and Mountain Roads



Driving on steep hills or mountains is different from driving in flat or rolling terrain.

If you drive regularly in steep country, or if you're planning to visit there, here are some tips that can make your trips safer and more enjoyable.

- Keep your vehicle in good shape. Check all fluid levels and also the brakes, tires, cooling system and transmission. These parts can work hard on mountain roads.
- Know how to go down hills. The most important thing to know is this: let your engine do some of the slowing down. Shift to a lower gear when you go down a steep or long hill.

 **CAUTION:**

If you don't shift down, your brakes could get so hot that they wouldn't work well. You would then have poor braking or even none going down a hill. You could crash. Shift down to let your engine assist your brakes on a steep downhill slope.

 **CAUTION:**

Coasting downhill in NEUTRAL (N) or with the ignition off is dangerous. Your brakes will have to do all the work of slowing down. They could get so hot that they wouldn't work well. You would then have poor braking or even none going down a hill. You could crash. Always have your engine running and your vehicle in gear when you go downhill.

- Know how to go uphill. You may want to shift down to a lower gear. The lower gears help cool your engine and transmission, and you can climb the hill better.
- Stay in your own lane when driving on two-lane roads in hills or mountains. Don't swing wide or cut across the center of the road. Drive at speeds that let you stay in your own lane.
- As you go over the top of a hill, be alert. There could be something in your lane, like a stalled car or an accident.
- You may see highway signs on mountains that warn of special problems. Examples are long grades, passing or no-passing zones, a falling rocks area or winding roads. Be alert to these and take appropriate action.

Winter Driving



Here are some tips for winter driving:

- Have your Corvette in good shape for winter.
- You may want to put winter emergency supplies in your vehicle.



Include an ice scraper, a small brush or broom, a supply of windshield washer fluid, a rag, some winter outer clothing, a small shovel, a flashlight, a red cloth and a couple of reflective warning triangles. And, if you will be driving under severe conditions, include a small bag of sand, a piece of old carpet or a couple of burlap bags to help provide traction. Be sure you properly secure these items in your vehicle.

Driving on Snow or Ice

Most of the time, those places where your tires meet the road probably have good traction.

However, if there is snow or ice between your tires and the road, you can have a very slippery situation. You'll have a lot less traction or "grip" and will need to be very careful.



What's the worst time for this? "Wet ice." Very cold snow or ice can be slick and hard to drive on. But wet ice can be even more trouble because it may offer the least traction of all.

You can get wet ice when it's about freezing (32°F; 0°C) and freezing rain begins to fall. Try to avoid driving on wet ice until salt and sand crews can get there.

Whatever the condition -- smooth ice, packed, blowing or loose snow -- drive with caution.

Keep your ASR system on. It improves your ability to accelerate when driving on a slippery road. Even though your vehicle has the ASR system, you'll want to slow down and adjust your driving to the road conditions. See "ASR System" in the Index.

Your anti-lock brakes improve your vehicle's stability when you make a hard stop on a slippery road. Even though you have the anti-lock braking system, you'll want to begin stopping sooner than you would on dry pavement. See "Anti-Lock" in the Index.

- Allow greater following distance on any slippery road.
- Watch for slippery spots. The road might be fine until you hit a spot that's covered with ice. On an otherwise clear road, ice patches may appear in shaded areas where the sun can't reach: around clumps of trees, behind buildings or under bridges. Sometimes the surface of a curve or an overpass may remain icy when the surrounding roads are clear. If you see a patch of ice ahead of you, brake before you are on it. Try not to brake while you're actually on the ice, and avoid sudden steering maneuvers.

If You're Caught in a Blizzard

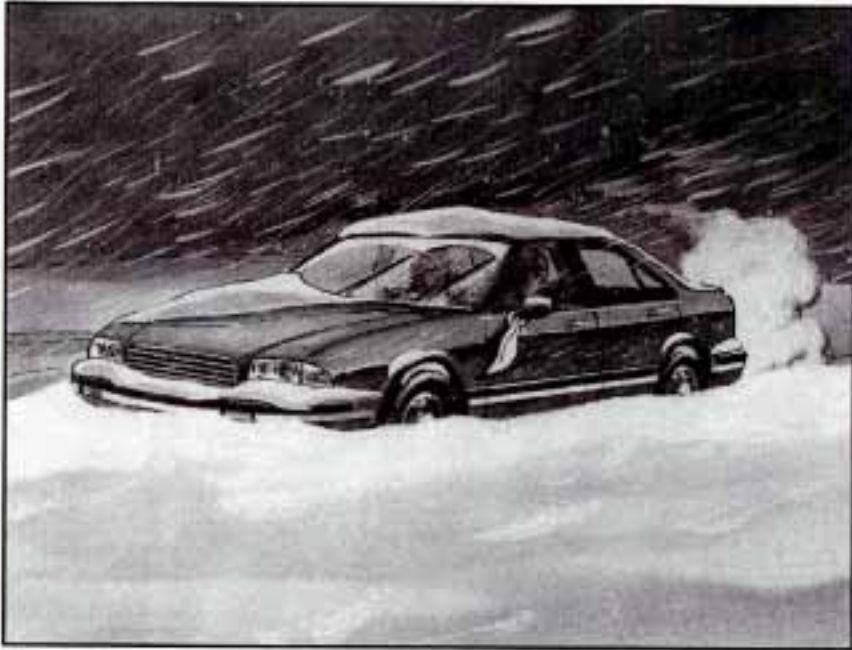

If you are stopped by heavy snow, you could be in a serious situation. You should probably stay with your vehicle unless you know for sure that you are near help and you can hike through the snow. Here are some things to do to summon help and keep yourself and your passengers safe:

- Turn on your hazard flashers.

- Tie a red cloth to your vehicle to alert police that you've been stopped by the snow.
- Put on extra clothing or wrap a blanket around you. If you have no blankets or extra clothing, make body insulators from newspapers, burlap bags, rags, floor mats -- anything you can wrap around yourself or tuck under your clothing to keep warm.



You can run the engine to keep warm, but be careful.

 **CAUTION:**

Snow can trap exhaust gases under your vehicle. This can cause deadly CO (carbon monoxide) gas to get inside. CO could overcome you and kill you. You can't see it or smell it, so you might not know it is in your vehicle. Clear away snow from around the base of your vehicle, especially any that is blocking your exhaust pipe. And check around again from time to time to be sure snow doesn't collect there.

Open a window just a little on the side of the vehicle that's away from the wind. This will help keep CO out.

Run your engine only as long as you must. This saves fuel. When you run the engine, make it go a little faster than just idle. That is, push the accelerator slightly. This uses less fuel for the heat that you get and it keeps the battery charged. You will need a well-charged battery to restart the vehicle, and possibly for signaling later on with your headlamps. Let the heater run for awhile.

Then, shut the engine off and close the window almost all the way to preserve the heat. Start the engine again and repeat this only when you feel really uncomfortable from the cold. But do it as little as possible. Preserve the fuel as long as you can. To help keep warm, you can get out of the vehicle and do some fairly vigorous exercises every half hour or so until help comes.

Loading Your Vehicle



TIRE-LOADING INFORMATION

| OCCUPANTS | | VEHICLE CAP. WT. | |
|-----------|----------|------------------|---------|
| FRT. | CTR. RR. | TOTAL | LBS. KG |

| MAX. LOADING & GVWR SAME AS VEHICLE CAPACITY WEIGHT | | | |
|---|--|-----------|----------------------------|
| TIRE SIZE | | SPEED RTG | COLD TIRE PRESSURE PSI/KPa |

FRT.
RR.
SPA.

IF TIRES ARE HOT, ADD 4PSI/28KPa
SEE OWNER'S MANUAL FOR ADDITIONAL INFORMATION

Two labels on your vehicle show how much weight it may properly carry. The Tire-Loading Information label found on the rear edge of the driver's door tells you the proper size, speed rating and recommended inflation. It also gives you important information about the number of people that can be in your vehicle and the total weight that you can carry. This weight is called Vehicle Capacity Weight and includes the weight of all occupants, cargo, and all nonfactory-installed options.



MFD BY GENERAL MOTORS CORP
DATE GVWR GAWR FRT GAWR RR

THIS VEHICLE CONFORMS TO ALL APPLICABLE U.S. FEDERAL MOTOR VEHICLE SAFETY, BUMPER, AND THEFT PREVENTION STANDARDS IN EFFECT ON THE DATE OF MANUFACTURE SHOWN ABOVE.

The other label is the Certification label, found on the rear edge of the driver's door. It tells you the gross weight capacity of your vehicle, called the GVWR (Gross Vehicle Weight Rating). The GVWR includes the weight of the vehicle, all occupants, fuel and cargo. Never exceed the GVWR for your vehicle, or the GAWR (Gross Axle Weight Rating) for either the front or rear axle.

And, if you do have a heavy load, you should spread it out. Don't carry more than 100 pounds (45 kg) in your rear area.

CAUTION:

Do not load your vehicle any heavier than the GVWR, or either the maximum front or rear GAWR. If you do, parts on your vehicle can break, or it can change the way your vehicle handles. These could cause you to lose control. Also, overloading can shorten the life of your vehicle.

NOTICE:

Your warranty does not cover parts or components that fail because of overloading.

If you put things inside your vehicle -- like suitcases, tools, packages or anything else -- they will go as fast as the vehicle goes. If you have to stop or turn quickly, or if there is a crash, they'll keep going.

CAUTION:

Things you put inside your vehicle can strike and injure people in a sudden stop or turn, or in a crash.

- Put things in the rear area of your vehicle. Try to spread the weight evenly.
- Never stack heavier things, like suitcases, inside the vehicle so that some of them are above the tops of the seats.
- Don't leave an unsecured child restraint in your vehicle.
- When you carry something inside the vehicle, secure it whenever you can.

Towing A Trailer

Your Corvette is neither designed nor intended to tow a trailer.

NOTES



Section 5 Problems on the Road

Here you'll find what to do about some problems that can occur on the road.

Hazard Warning Flashers



Your hazard warning flashers let you warn others. They also let police know you have a problem. Your front and rear turn signal lamps will flash on and off.



Press the button to make your front and rear turn signal lamps flash on and off.

Your hazard warning flashers work no matter what position your key is in, and even if the key isn't in.

To turn off the flashers, pull out on the collar.

When the hazard warning flashers are on, your turn signals won't work.

Other Warning Devices

If you carry reflective triangles, you can set one up at the side of the road about 300 feet (100 m) behind your vehicle.

Jump Starting

If your battery has run down, you may want to use another vehicle and some jumper cables to start your Corvette. But please use the following steps to do it safely.

NOTICE:

Ignoring these steps could result in costly damage to your vehicle that wouldn't be covered by your warranty.

Trying to start your Corvette by pushing or pulling it could damage your vehicle, even if you have a manual transmission. And if you have an automatic transmission, it won't start that way.



CAUTION:

Batteries can hurt you. They can be dangerous because:

- They contain acid that can burn you.
- They contain gas that can explode or ignite.
- They contain enough electricity to burn you.

If you don't follow these steps exactly, some or all of these things can hurt you.

1. Check the other vehicle. It must have a 12-volt battery with a negative ground system.

NOTICE:

If the other system isn't a 12-volt system with a negative ground, both vehicles can be damaged.

2. Get the vehicles close enough so the jumper cables can reach, but be sure the vehicles aren't touching each other. If they are, it could cause a ground connection you don't want. You wouldn't be able to start your Corvette, and the bad grounding could damage the electrical systems.
3. Turn off the ignition on both vehicles. Unplug unnecessary accessories plugged into the cigarette lighter or accessory plug. Turn off all lamps that aren't needed as well as radios. This will avoid sparks and help save both batteries. In addition, it could save your radio!

NOTICE:

If you leave your radio on, it could be badly damaged. The repairs wouldn't be covered by your warranty.

4. Open the hoods and locate the batteries. Find the positive (+) and negative (-) terminals on each.

 **CAUTION:**

An electric fan can start up even when the engine is not running and can injure you. Keep hands, clothing and tools away from any underhood electric fan.

 **CAUTION:**

Using a match near a battery can cause battery gas to explode. People have been hurt doing this, and some have been blinded. Use a flashlight if you need more light.

CAUTION: (Continued)

CAUTION: (Continued)

Be sure the battery has enough water. You don't need to add water to the Delco Freedom[®] battery installed in every new GM vehicle. But if a battery has filler caps, be sure the right amount of fluid is there. If it is low, add water to take care of that first. If you don't, explosive gas could be present. Battery fluid contains acid that can burn you. Don't get it on you. If you accidentally get it in your eyes or on your skin, flush the place with water and get medical help immediately.

5. Check that the jumper cables don't have loose or missing insulation. If they do, you could get a shock. The vehicles could be damaged, too.

⚠ CAUTION:

Fans or other moving engine parts can injure you badly. Keep your hands away from moving parts once the engines are running.

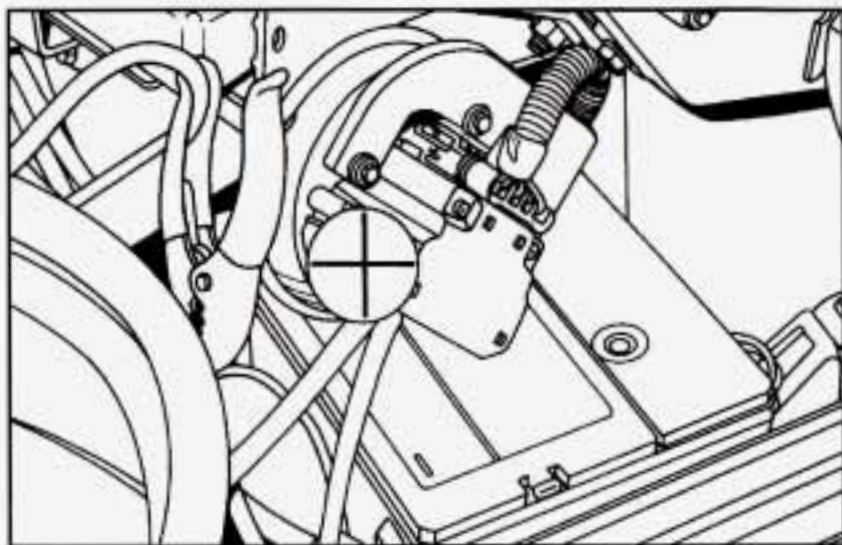

6. Positive (+) goes to positive (+) and negative (-) goes to negative (-) or a metal engine part. Connect the red positive (+) cable to the positive (+) terminal of the vehicle with the dead battery. Use a remote positive (+) terminal if the vehicle has one.



7. Don't let the other end touch metal. Connect it to the positive (+) terminal of the good battery. Use a remote positive (+) terminal if the vehicle has one.

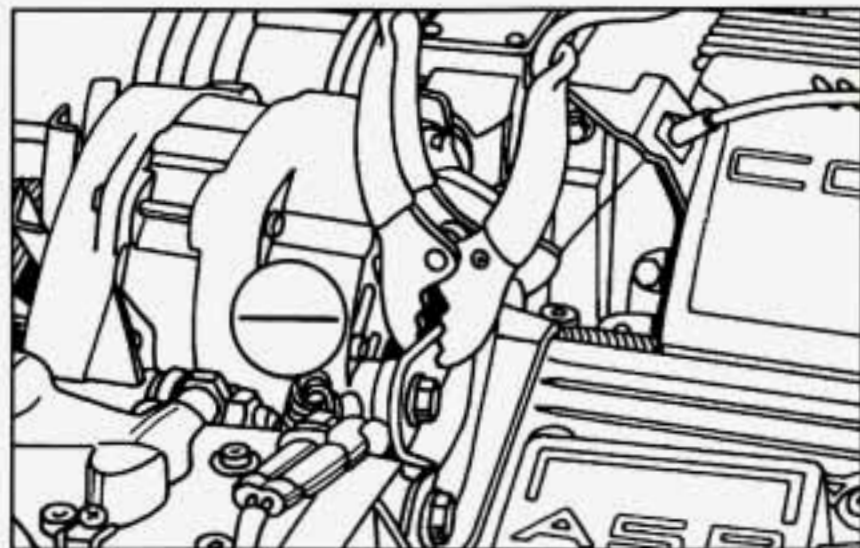

8. Now connect the black negative (-) cable to the good battery's negative (-) terminal. Don't let the other end touch anything until the next step.

9. The other end of the negative cable doesn't go to the dead battery. It goes to a heavy, unpainted metal part on the engine of the vehicle with the dead battery. Attach the cable at least 18 inches (45 cm) away from the dead battery, but not near engine parts that move. The electrical connection is just as good there, but the chance of sparks getting back to the battery is much less.
10. Now start the vehicle with the good battery and run the engine for a while.

11. Try to start the vehicle with the dead battery. If it won't start after a few tries, it probably needs service.
12. Remove the cables in reverse order to prevent electrical shorting. Take care that they don't touch each other or any other metal.

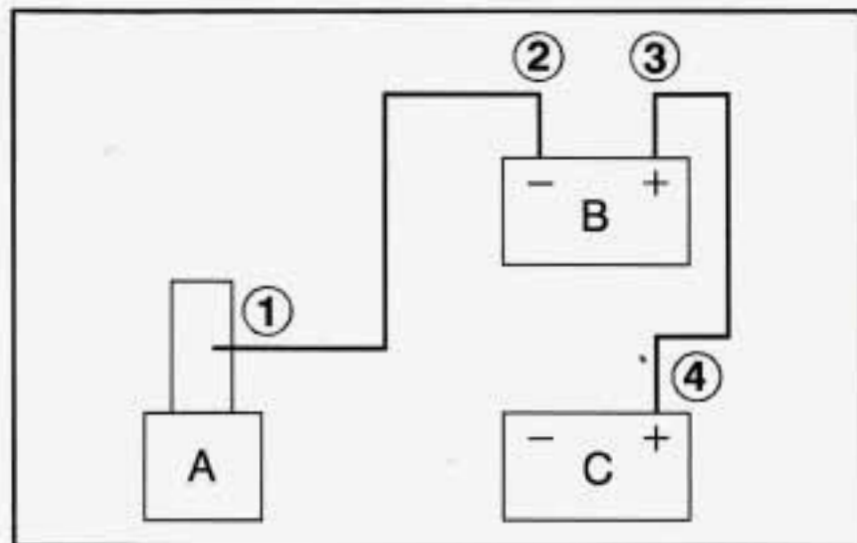

- A. Heavy Metal Engine Part
B. Good Battery
C. Dead Battery

Towing Your Vehicle

Try to have a Chevrolet dealer or a professional towing service tow your Corvette. They can provide the right equipment and know how to tow your vehicle without damage. See "Roadside Assistance" in the Index.

If your vehicle has been changed or modified since it was factory new by adding aftermarket items like fog lamps, aero skirting, or special tires and wheels, these instructions and illustrations may not be correct.

Before you do anything, turn on the hazard warning flashers.

When you call, tell the towing service:

- That your vehicle cannot be towed from the rear with sling-type equipment.
- That your vehicle has rear-wheel drive.
- The make, model and year of your vehicle.
- Whether you can still move the shift lever.
- If there was an accident, what was damaged.

When the towing service arrives, let the tow operator know that this manual contains detailed towing instructions and illustrations. The operator may want to see them.



⚠ CAUTION:

To help avoid injury to you or others:

- Never let passengers ride in a vehicle that is being towed.
- Never tow faster than safe or posted speeds.
- Never tow with damaged parts not fully secured.
- Never get under your vehicle after it has been lifted by the tow truck.
- Always secure the vehicle on each side with separate safety chains when towing it.
- Never use J-hooks. Use T-hooks instead.

⚠ CAUTION:

A vehicle can fall from a car carrier if it isn't adequately secured. This can cause a collision, serious personal injury and vehicle damage. The vehicle should be tightly secured with chains or steel cables before it is transported.

Don't use substitutes (ropes, leather straps, canvas webbing, etc.) that can be cut by sharp edges underneath the towed vehicle. Always use T-hooks inserted in the T-hook slots. Never use J-hooks. They will damage drivetrain and suspension components.

When your vehicle is being towed, have the ignition key OFF. The steering wheel should be clamped in a straight-ahead position, with a clamping device designed for towing service. Do not use the vehicle's steering column lock for this. The transmission should be in NEUTRAL (N) and the parking brake released.

Front Towing

Tow Limits -- 35 mph (56 km/h), 50 miles (80 km)

Don't have your vehicle towed on the rear wheels unless you must. If the vehicle must be towed on the rear wheels, don't exceed the above limits or your transmission will be damaged. Go slow over rough ground, and position one wheel at a time (angled 45°) if you have to go over curbs and rises. Wheels at the lifted end should be at least 4 inches (100 mm) above the ground. If these limits must be exceeded, then the rear wheels have to be supported on a dolly.

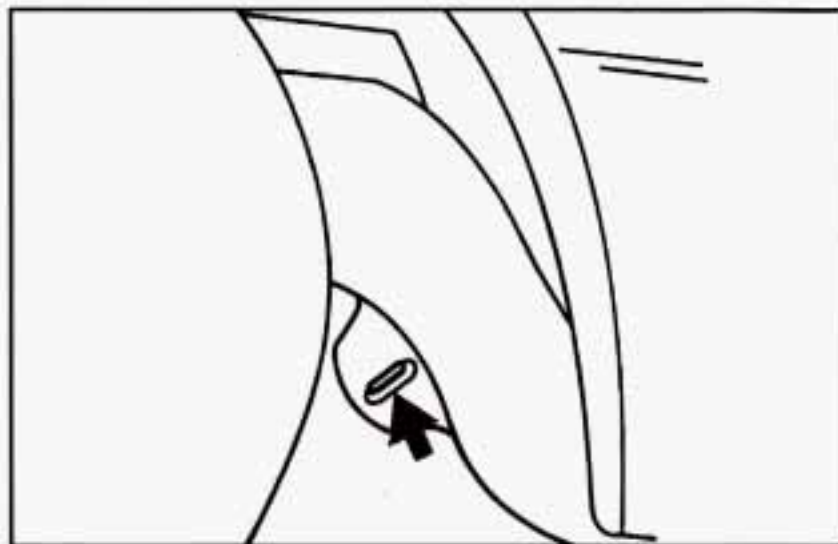

Attach T-hook chains on both sides into slotted holes behind and inboard of the front wheels. Use these slots for sling equipment and car carrier securing.

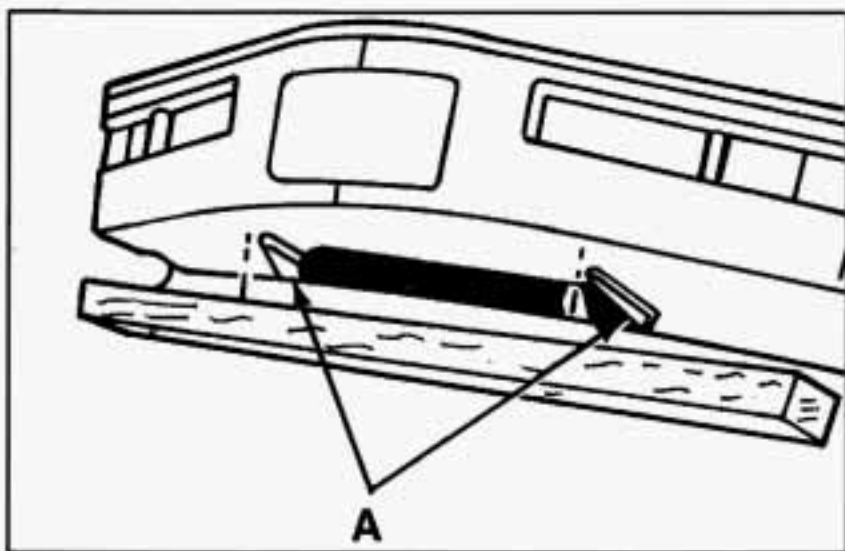

Position a 4" \times 4" wood beam across sling chains contacting under fascia just ahead of the curb protect brackets (A).

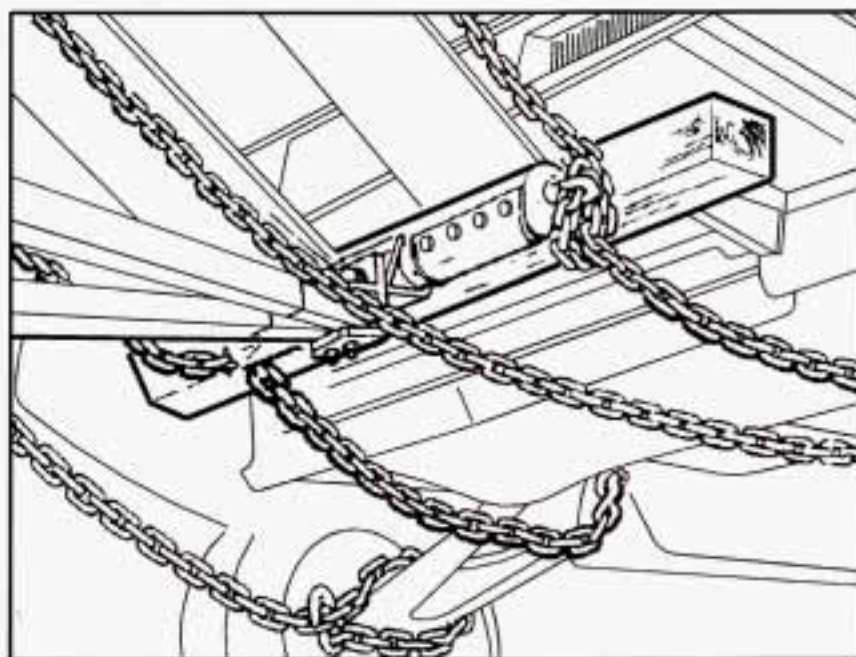

Position the sling crossbar against the front of the 4" \times 4" beam.

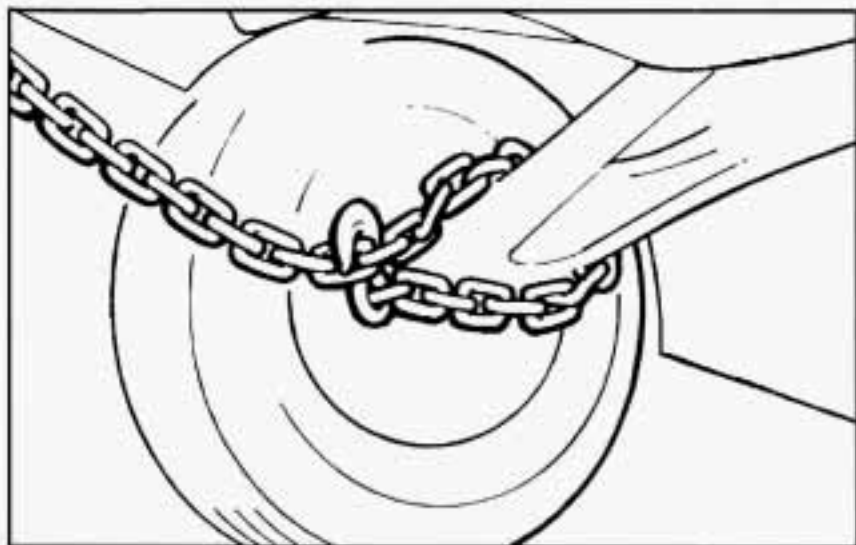

Attach a separate safety chain around the outboard end of each lower control arm.

Rear Towing

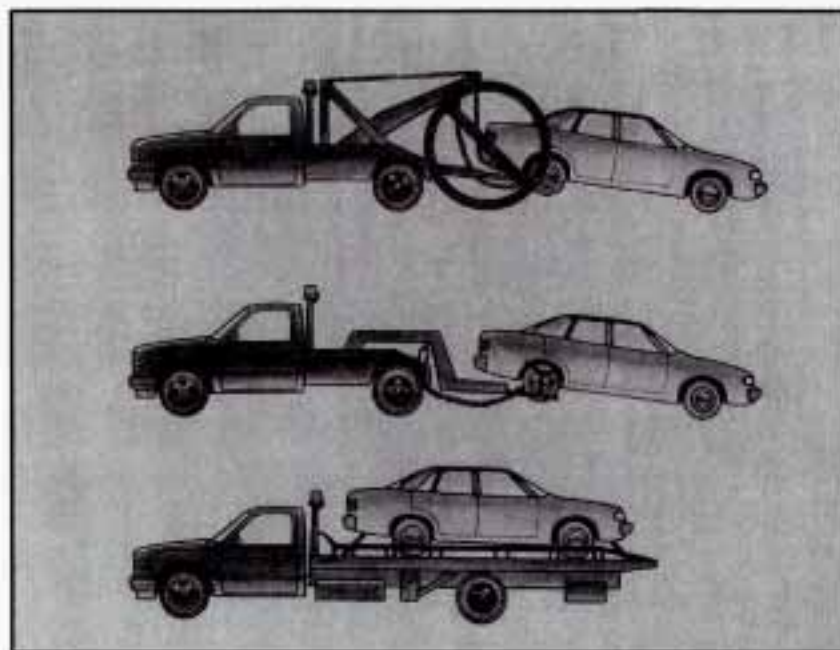

NOTICE:

Do not tow with sling-type equipment or rear bumper valance will be damaged.

Use wheel-lift or car carrier equipment. Additional ramping may be required for car carrier equipment.

Use safety chains and wheel straps.

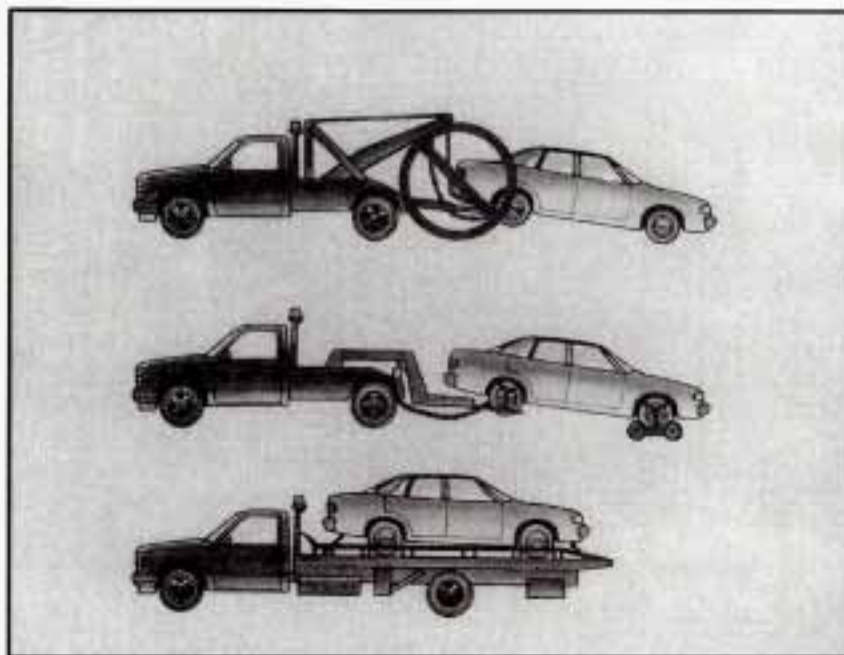

NOTICE:

Towing a vehicle over rough surfaces could damage a vehicle. Damage can occur from vehicle-to-ground or vehicle-to-wheel-lift equipment. To help avoid damage, install a towing dolly and raise the vehicle until adequate clearance is obtained between the ground and/or wheel-lift equipment.

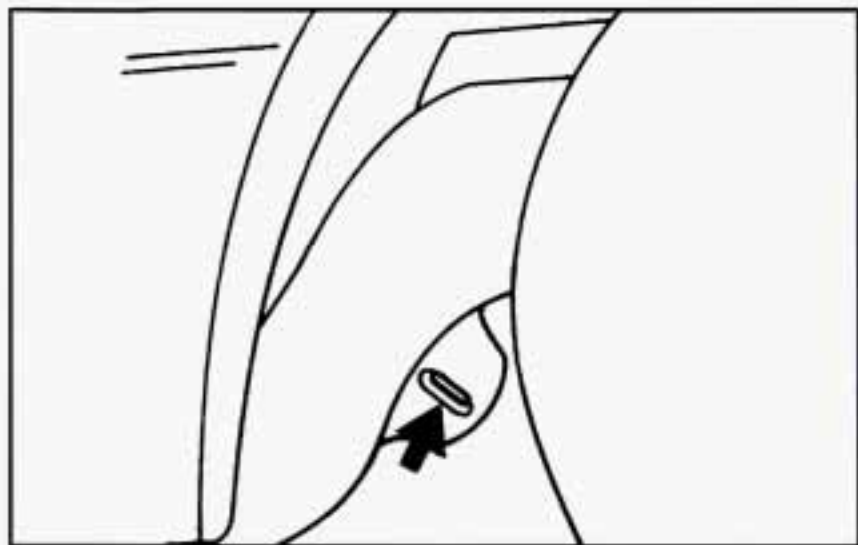

Attach T-hook chains in slots forward and just inboard of the rear wheels on both sides.

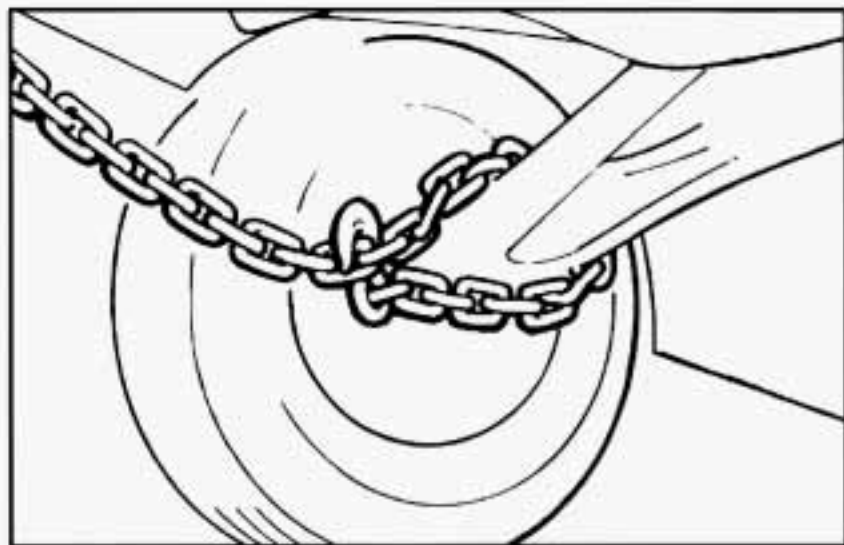

Attach a separate safety chain around the outboard end of each lower control arm.

NOTICE:

Do not allow chains to contact spring, as damage to spring could result.

Engine Overheating

You will find an engine coolant temperature gauge on the instrument cluster and a LOW COOLANT light on the Driver Information Center.

If Steam Is Coming From Your Engine



CAUTION:

Steam from an overheated engine can burn you badly, even if you just open the hood. Stay away from the engine if you see or hear steam coming from it. Just turn it off and get everyone away from the vehicle until it cools down. Wait until there is no sign of steam or coolant before opening the hood.

If you keep driving when your engine is overheated, the liquids in it can catch fire. You or others could be badly burned. Stop your engine if it overheats, and get out of the vehicle until the engine is cool.

NOTICE:

If your engine catches fire because you keep driving with no coolant, your vehicle can be badly damaged. The costly repairs would not be covered by your warranty.

If No Steam Is Coming From Your Engine

If you get the overheat warning but see or hear no steam, the problem may not be too serious. Sometimes the engine can get a little too hot when you:

- Climb a long hill on a hot day.
- Stop after high-speed driving.
- Idle for long periods in traffic.

If you get the overheat warning with no sign of steam, try this for a minute or so:

1. Turn off your air conditioner.
2. Turn on your heater to full hot at the highest fan speed and open the window as necessary.
3. If you're in a traffic jam, shift to NEUTRAL (N); otherwise, shift to the highest gear while driving -- AUTOMATIC OVERDRIVE (Ⓢ) or DRIVE (D) for automatic transmissions.

If you no longer have the overheat warning, you can drive. Just to be safe, drive slower for about 10 minutes. If the warning doesn't come back on, you can drive normally.

If the warning continues, pull over, stop, and park your vehicle right away.

If there's still no sign of steam, you can idle the engine for two or three minutes while you're parked, to see if the warning stops. But then, if you still have the warning, *turn off the engine and get everyone out of the vehicle* until it cools down.

You may decide not to lift the hood but to get service help right away.

When you decide it's safe to lift the hood, here's what you'll see:

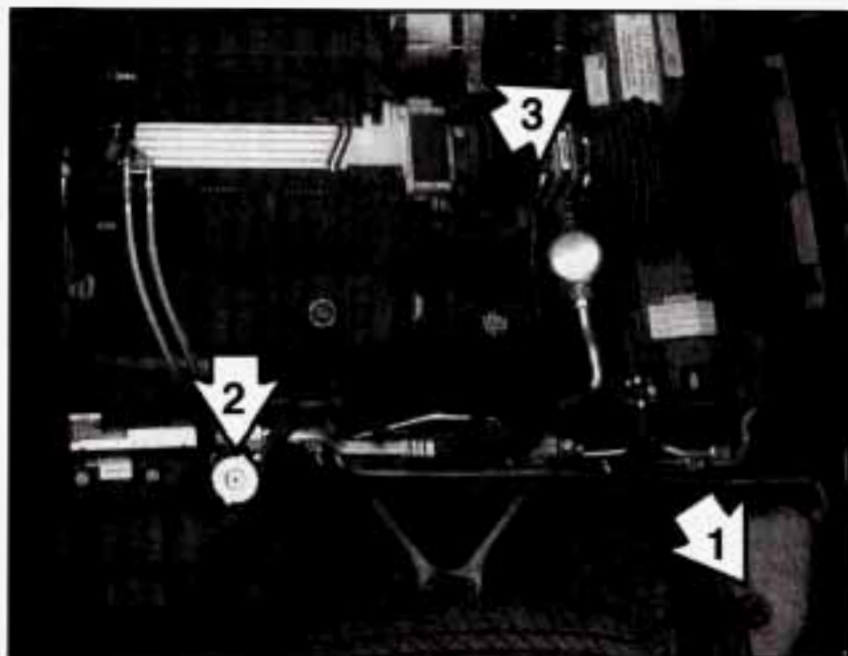

1. Coolant Recovery Tank
2. Coolant High Fill Reservoir with Pressure Cap
3. Electric Engine Fans

⚠ CAUTION:

An electric fan under the hood can start up even when the engine is not running and can injure you. Keep hands, clothing and tools away from any underhood electric fan.

If the coolant inside the coolant recovery tank is boiling, don't do anything else until it cools down.

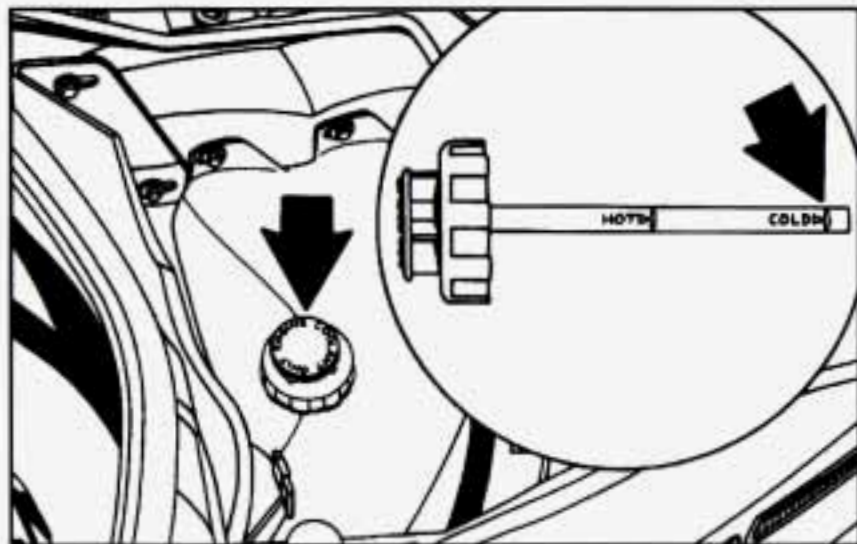

When it is cool, remove the coolant recovery tank cap and look at the dipstick.

The coolant level should be at or above COLD. If it isn't, you may have a leak in the radiator hoses, heater hoses, radiator, water pump or somewhere else in the cooling system.

CAUTION:

Heater and radiator hoses, and other engine parts, can be very hot. Don't touch them. If you do, you can be burned.

Don't run the engine if there is a leak. If you run the engine, it could lose all coolant. That could cause an engine fire, and you could be burned. Get any leak fixed before you drive the vehicle.

NOTICE:

Engine damage from running your engine without coolant isn't covered by your warranty.

If there seems to be no leak, with the engine on, check to see if the electric engine fans are running. If the engine is overheating, both fans should be running. If they aren't, your vehicle needs service.

How to Add Coolant to the Coolant Recovery Tank

If you haven't found a problem yet, but the coolant level isn't at or above the COLD mark, add a 50/50 mixture of *clean water* (preferably distilled) and DEX-COOL™ (orange-colored, silicate-free) antifreeze at the coolant recovery tank. (See "Engine Coolant" in the Index for more information.)

CAUTION:

Adding only plain water to your cooling system can be dangerous. Plain water, or some other liquid like alcohol, can boil before the proper coolant mix will. Your vehicle's coolant warning system is set for the proper coolant mix. With plain water or the wrong mix, your engine could get too hot but you wouldn't get the overheat warning. Your engine could catch fire and you or others could be burned. Use a 50/50 mix of clean water and DEX-COOL™ antifreeze.

NOTICE:

In cold weather, water can freeze and crack the engine, radiator, heater core and other parts. Use the recommended coolant and the proper coolant mix.



⚠ CAUTION:

You can be burned if you spill coolant on hot engine parts. Coolant contains ethylene glycol and it will burn if the engine parts are hot enough. Don't spill coolant on a hot engine.

When the coolant in the coolant recovery tank is at or above the COLD mark, start your vehicle.

If the overheat warning continues, there's one more thing you can try. You can add the proper coolant mix directly to the coolant high fill reservoir, but be sure the cooling system is cool before you do it.

⚠ CAUTION:

Steam and scalding liquids from a hot cooling system can blow out and burn you badly. They are under pressure, and if you turn the coolant high fill reservoir pressure cap -- even a little -- they

CAUTION: (Continued)

CAUTION: (Continued)

can come out at high speed. Never turn the cap when the cooling system, including the coolant high fill reservoir pressure cap, is hot. Wait for the cooling system and coolant high fill reservoir pressure cap to cool if you ever have to turn the pressure cap.



How to Add Coolant to the Coolant High Fill Reservoir

NOTICE:

Your engine has a specific coolant high fill reservoir fill procedure. Failure to follow this procedure could cause your engine to overheat and be severely damaged.



1. You can remove the coolant high fill reservoir pressure cap when the cooling system, including the coolant high fill reservoir pressure cap and upper radiator hose, is no longer hot. Turn the pressure cap slowly counterclockwise until it first stops. (Don't press down while turning the pressure cap.)

If you hear a hiss, wait for that to stop. A hiss means there is still some pressure left.



2. Then keep turning the pressure cap, but now push down as you turn it. Remove the pressure cap.

⚠ CAUTION:

You can be burned if you spill coolant on hot engine parts. Coolant contains ethylene glycol, and it will burn if the engine parts are hot enough. Don't spill coolant on a hot engine.



3. After the engine cools, open the air bleed valve on the water pump inlet.



4. Fill with the proper mix. Add coolant until you see a steady stream of coolant coming from the bleed valve.
5. Close the bleed valve.
6. Continue to fill the coolant high fill reservoir up to the base of the filler neck.
7. Rinse or wipe the spilled coolant from the engine compartment.

8. Start the engine and allow it to idle for approximately four minutes. By this time, the coolant level inside the coolant high fill reservoir will be lower. Add more of the proper mix through the filler neck until the level reaches the base of the filler neck.



9. Shut the engine off and replace the pressure cap. Be sure the arrows on the cap line up like this.



10. Then fill the coolant recovery tank to the proper level. For a complete drain, flush and refill, see your Chevrolet dealer or a Chevrolet Corvette Service Manual. To purchase a service manual, see "Service and Owner Publications" in the Index.

If a Tire Goes Flat

It's unusual for a tire to "blow out" while you're driving, especially if you maintain your tires properly. If air goes out of a tire, it's much more likely to leak out slowly. But if you should ever have a "blowout," here are a few tips about what to expect and what to do:

If a front tire fails, the flat tire will create a drag that pulls the vehicle toward that side. Take your foot off the accelerator pedal and grip the steering wheel firmly. Steer to maintain lane position, and then gently brake to a stop well out of the traffic lane.

A rear blowout, particularly on a curve, acts much like a skid and may require the same correction you'd use in a skid. In any rear blowout, remove your foot from the accelerator pedal. Get the vehicle under control by steering the way you want the vehicle to go. It may be very bumpy and noisy, but you can still steer. Gently brake to a stop -- well off the road if possible.

If a tire goes flat, the next part shows how to use your jacking equipment to change a flat tire safely. If your vehicle has Extended Mobility Tires (tires with "EMT" molded on the sidewalls), see "Extended Mobility Tires" in the Index.

Changing a Flat Tire

If a tire goes flat, avoid further tire and wheel damage by driving slowly to a level place. Turn on your hazard warning flashers.



CAUTION:

Changing a tire can cause an injury. The vehicle can slip off the jack and roll over you or other people. You and they could be badly injured. Find a level place to change your tire. To help prevent the vehicle from moving:

- 1. Set the parking brake firmly.**
- 2. Put an automatic transmission shift lever in PARK (P), or shift a manual transmission to FIRST (1) or REVERSE (R).**
- 3. Turn off the engine.**

To be even more certain the vehicle won't move, you can put blocks at the front and rear of the tire farthest away from the one being changed. That would be the tire on the other side of the vehicle, at the opposite end.



The following steps will tell you how to use the jack and change a tire.

Removing the Spare Tire and Tools

Note that if you've chosen the spare tire delete option, your vehicle is not equipped with a jack or wheel wrench, but does have a wheel lock key and wheel nut socket.

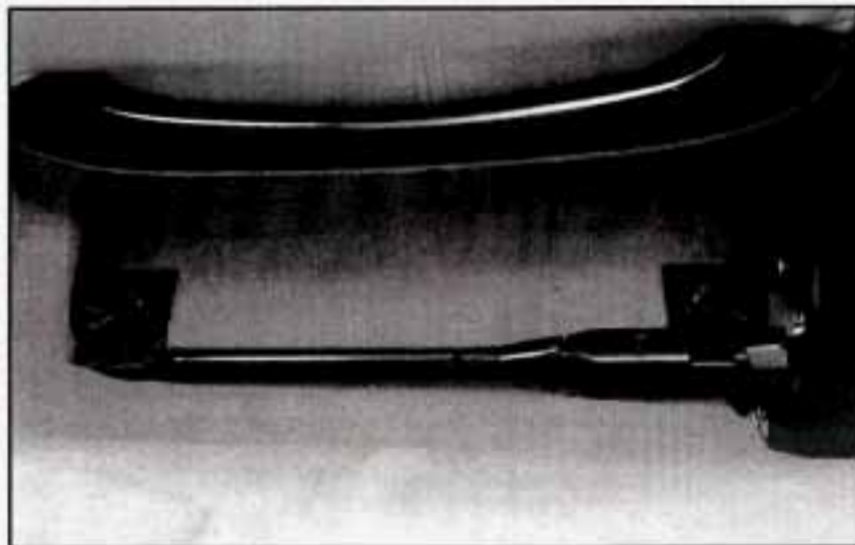

The wheel wrench is on the floor behind the driver's seat. Move the driver's seat all the way forward and fold the seatback forward. Loosen the wingnuts and slide the wheel wrench out of the clamps.



The jack, wheel nut socket and wheel lock key are in the rear storage compartment behind the passenger's seat.

Open the compartment door and remove the plastic tray. Lift the jack, wheel nut socket and wheel lock key out of the foam container.

Your Corvette wheel lock key has a unique registration number. The registration number is printed on a card included in your lock nut package. Also on this card is lost key replacement information. This number is *not* recorded by GM or your dealer, so be sure not to lose

this card. You will need the information if you ever lose your wheel lock key.

Always use the wheel nut socket when you use the wheel wrench provided with your Corvette. If you have someone else remove your wheels, make sure you give them the special wheel nut socket and wheel lock key.

NOTICE:

Your wheels could be damaged if the wheel nut socket is not used to remove your Corvette's wheels.

The wheel nut socket can be used with an air wrench or a torque wrench. The wheel lock key can be used with a torque wrench, but not with an air or impact wrench.

NOTICE:

Your wheel lock key or lock nuts could be damaged if an air or impact wrench is used with this key.

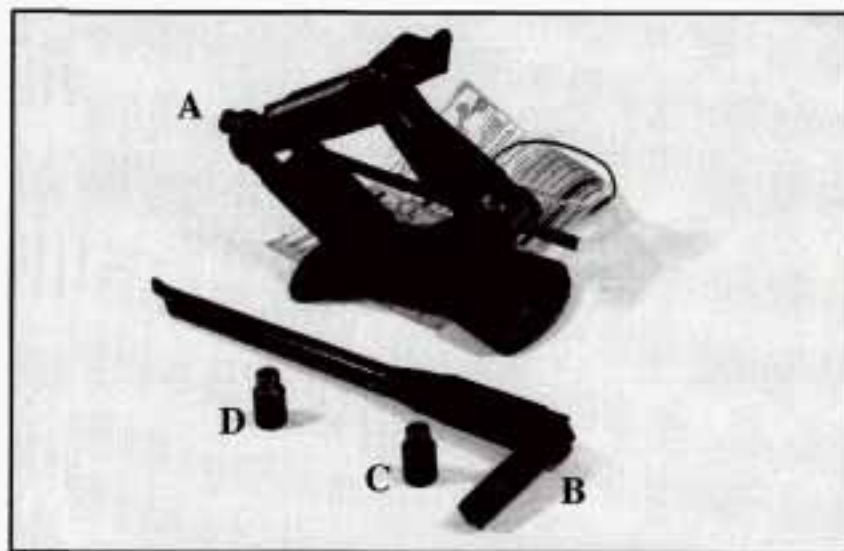

The tools you'll be using include the jack (A), wheel wrench (B), wheel nut socket (C) and wheel lock key (D).

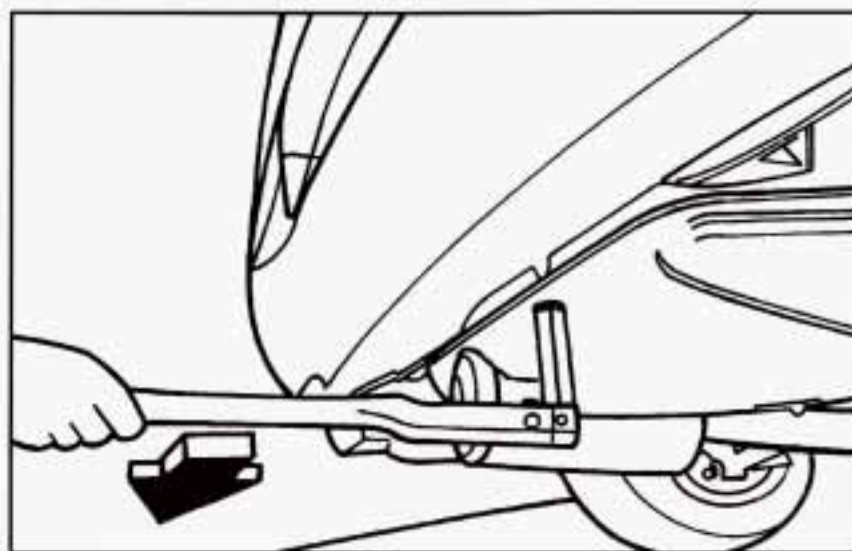

The spare tire is on a tire carrier tray under the rear end of your vehicle. See "Compact Spare Tire" later in this section for more information about the compact spare. To lower the tray, position yourself behind the vehicle facing the front and use the socket end of the wheel wrench to turn the latch bolt clockwise. Lower the tray about 1 inch (25.4 mm). Don't loosen the latch bolt too much, or the tray could fall.

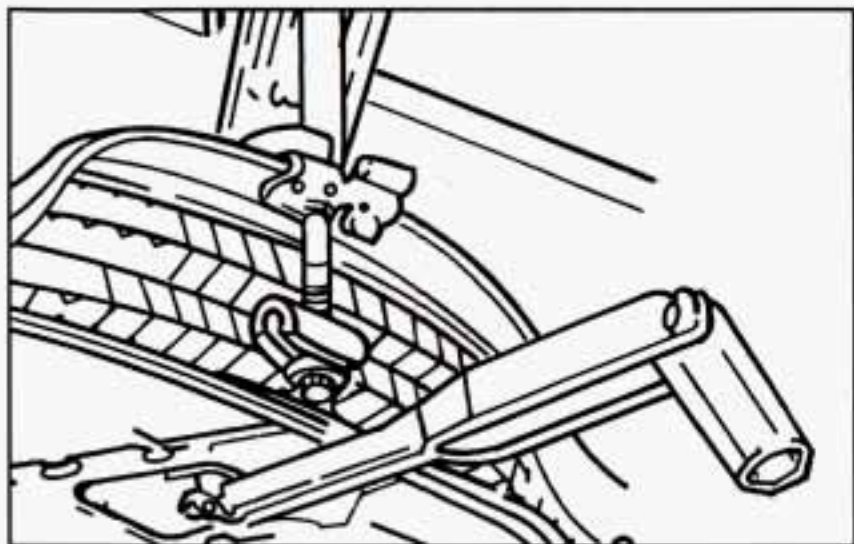

Put the hooked end of the wheel wrench into the slot in the tray. Insert the wheel wrench a little from the side so it isn't over the latch bolt. Pull up on the wheel wrench to lift the tray.

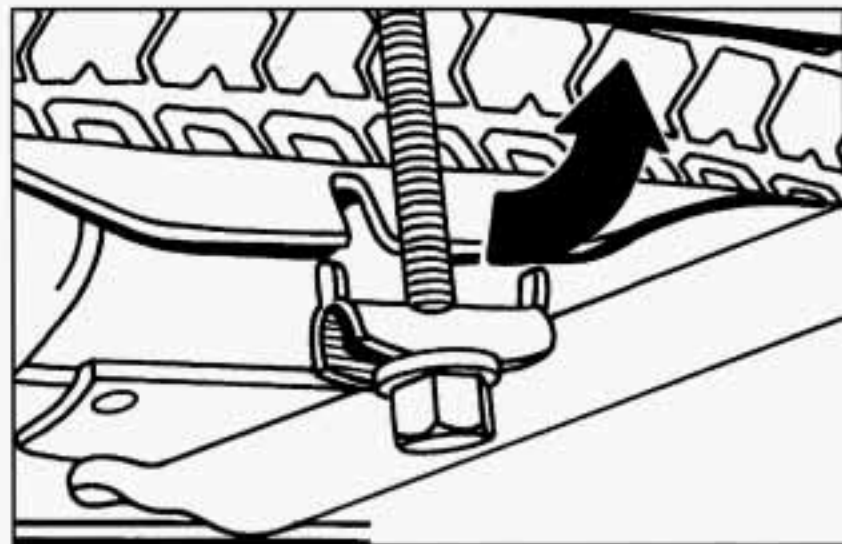

While holding the tray up with the wheel wrench, pull the latch bolt rearward to release it from the tray. If it won't come free, loosen it a little more.

Carefully lower the tray using the wheel wrench and remove the spare tire.

Removing the Flat Tire and Installing the Spare Tire

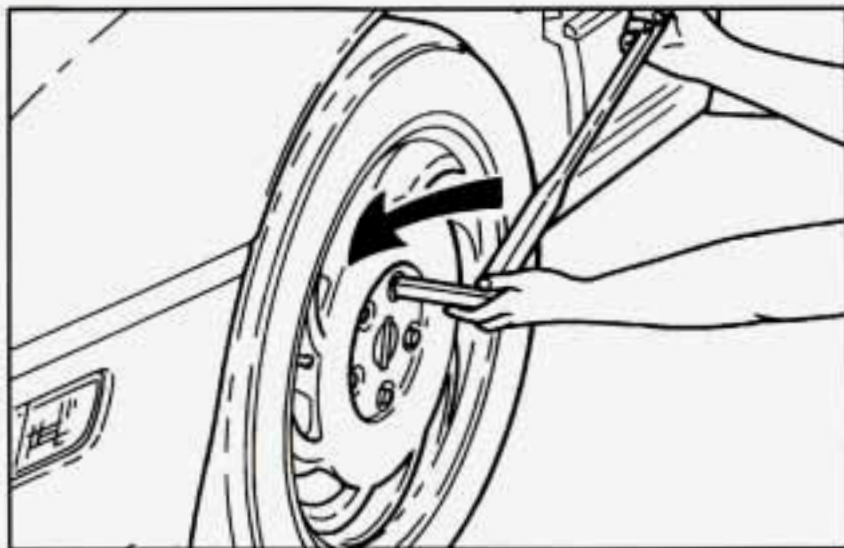

1. Remove the plastic wheel nut caps using the socket end of the wheel wrench by turning the wrench in the direction shown. Store the caps somewhere until you have the flat tire repaired or replaced.

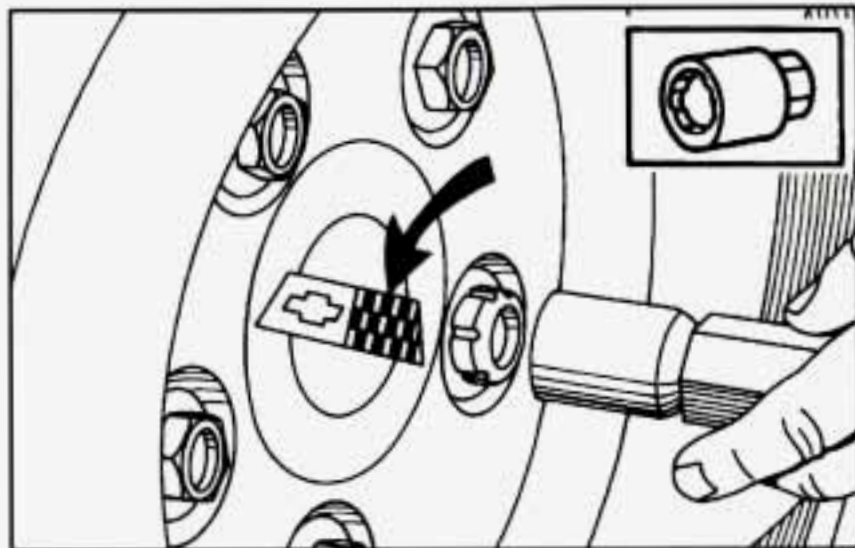

2. Each wheel will have one locknut. A special wheel lock key (removal tool) and instructions are provided. Attach the wheel lock key to the wheel wrench. Remove the locking wheel nut by turning counterclockwise.



3. Attach the wheel nut socket to the wheel wrench and loosen all the wheel nuts by turning the wrench in the direction shown. Don't remove them yet.

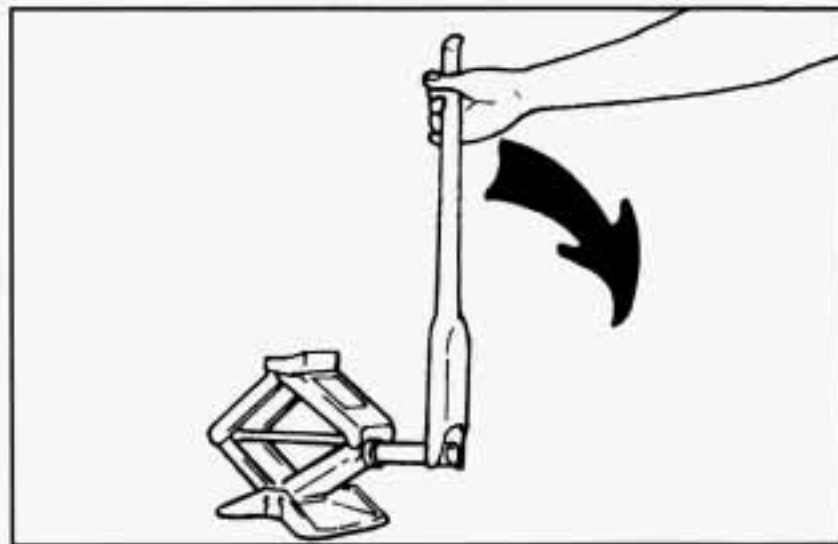

4. Attach the wheel wrench to the jack. Hold the wheel wrench handle so it forms a right angle with the jack, then turn it clockwise.

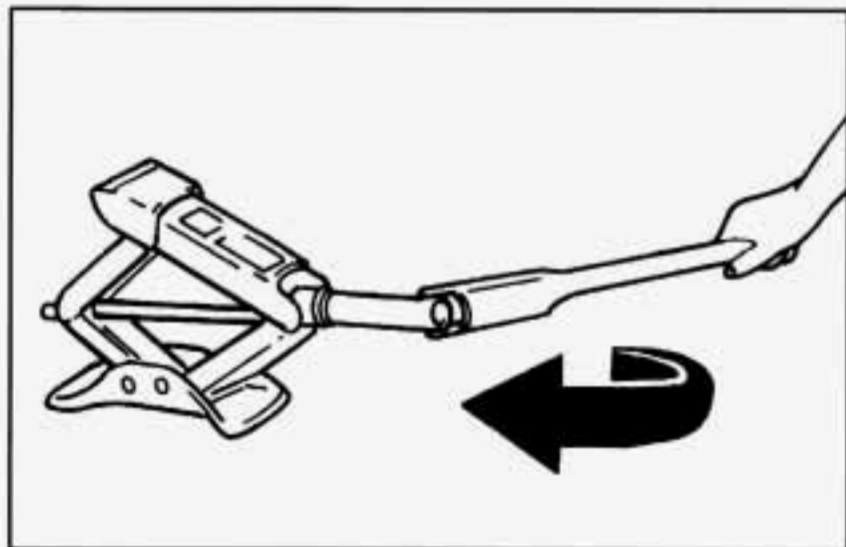

5. When you've turned the wrench almost as far as it will go, swing it around to the other side. Keep turning to raise the jack lift head a 3 inches (76.2 mm).

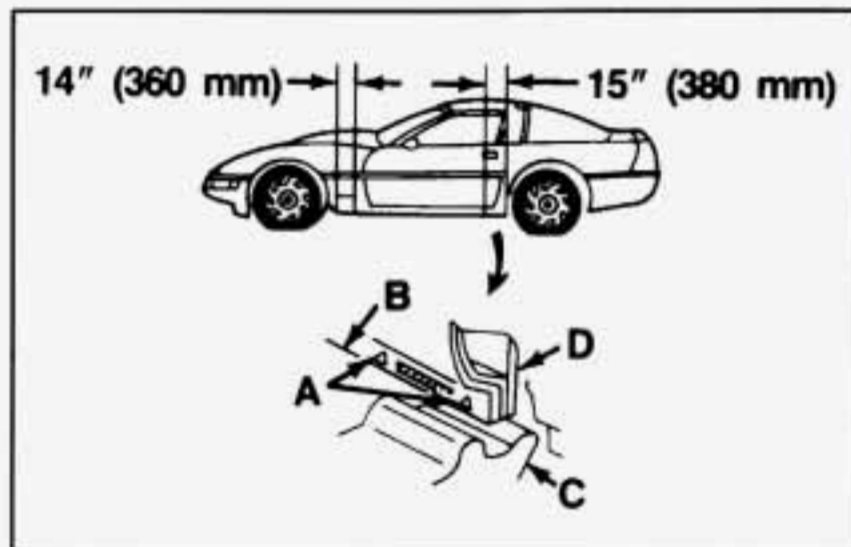

6. Position the jack under the vehicle. There are two locator triangles (A) on the panels (B) near each wheel. Raise the lift head (C) until it fits firmly under the steel rocker flange (D) between the triangles nearest the flat tire.

Stay away from the moldings or fender flanges to avoid damaging them.

⚠ CAUTION:

Getting under a vehicle when it is jacked up is dangerous. If the vehicle slips off the jack, you could be badly injured or killed. Never get under a vehicle when it is supported only by a jack.

NOTICE:

Raising your vehicle with the jack improperly positioned will damage the vehicle or may allow the vehicle to fall off the jack. Be sure to fit the jack lift head into the proper location before raising your vehicle.

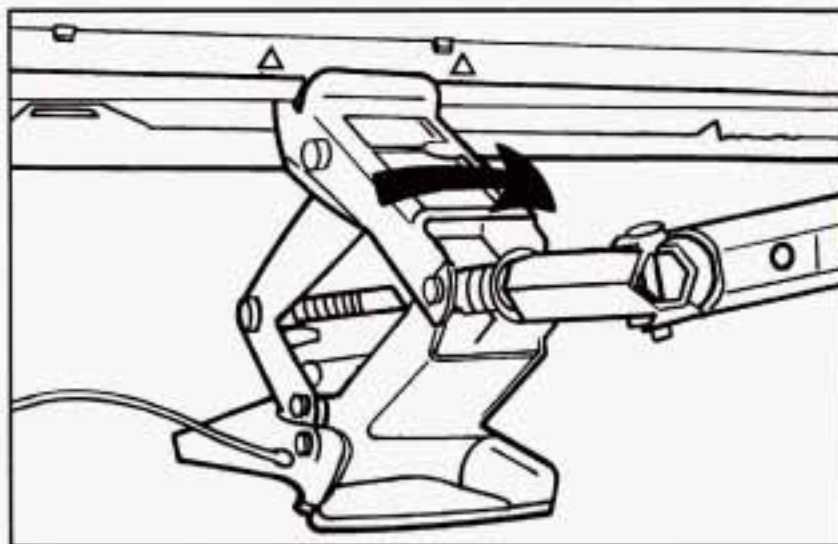

7. Raise the vehicle by turning the wheel wrench clockwise. Raise the vehicle far enough off the ground so there is enough room for the spare tire to fit. Remove all the wheel nuts and take off the flat tire.

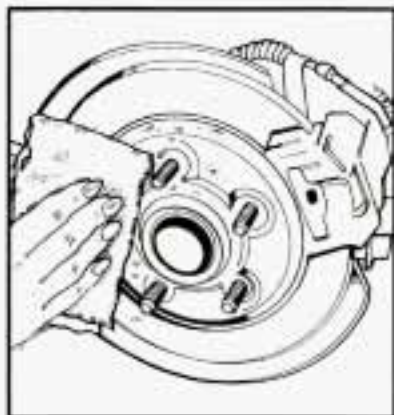

8. Remove any rust or dirt from the wheel bolts, mounting surfaces and spare wheel.

⚠ CAUTION:

Rust or dirt on the wheel, or on the parts to which it is fastened, can make the wheel nuts become loose after a time. The wheel could come off and cause an accident. When you change a wheel, remove any rust or dirt from the places where the wheel attaches to the vehicle. In an emergency, you can use a cloth or a paper towel to do this; but be sure to use a scraper or wire brush later, if you need to, to get all the rust or dirt off.

⚠ CAUTION:

Never use oil or grease on studs or nuts. If you do, the nuts might come loose. Your wheel could fall off, causing a serious accident.

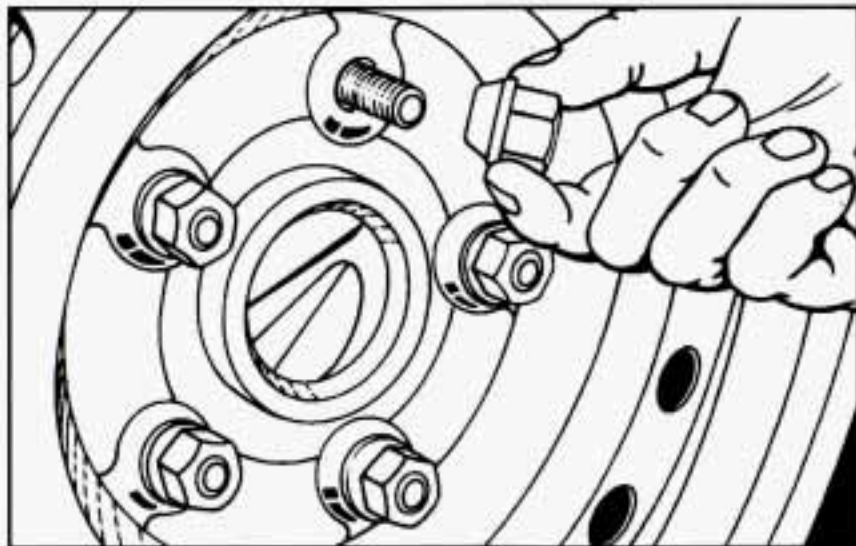

9. Replace the wheel nuts with the rounded end of the nuts toward the wheel. Tighten each nut by hand until the wheel is held against the hub.

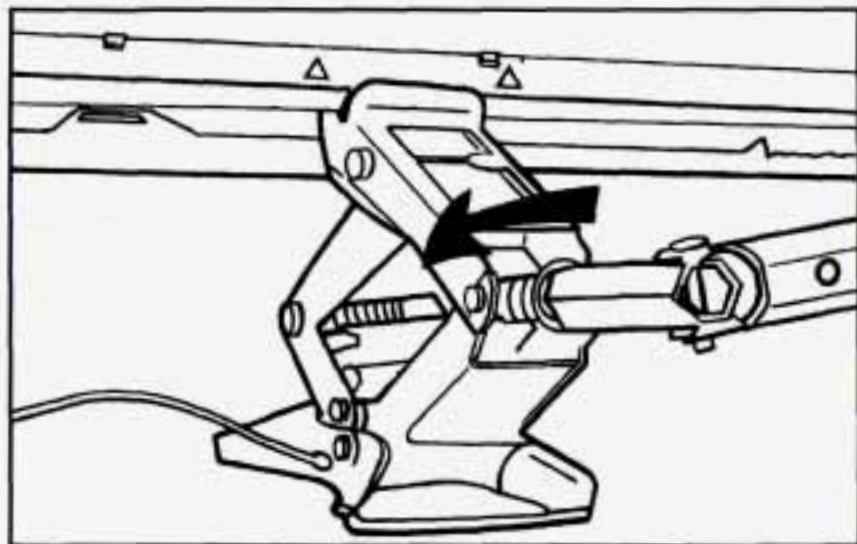

10. Lower the vehicle by turning the wheel wrench counterclockwise. Lower the jack completely.

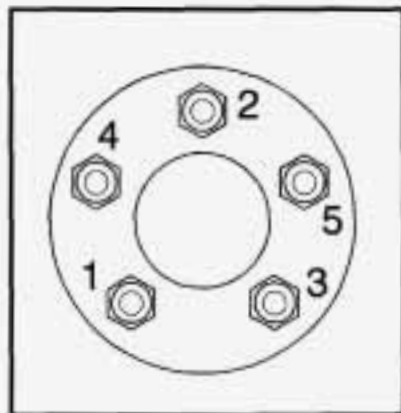

11. Tighten the wheel nuts firmly in a criss-cross sequence as shown.

⚠ CAUTION:

Incorrect wheel nuts or improperly tightened wheel nuts can cause the wheel to become loose and even come off. This could lead to an accident. Be sure to use the correct wheel nuts. If you have to replace them, be sure to get new GM original equipment wheel nuts.

Stop somewhere as soon as you can and have the nuts tightened with a torque wrench to 100 lb-ft (140 N·m).

NOTICE:

Improperly tightened wheel nuts can lead to brake pulsation and rotor damage. To avoid expensive brake repairs, evenly tighten the wheel nuts in the proper sequence and to the proper torque specification.

The LOW/FLAT TIRE or SERVICE LTPWS light will stay on as long as you are using the compact spare tire. It should go out when the original tire is replaced.

After you have the flat tire repaired or replaced, install the plastic nut caps and tighten them to 22 lb-in (2.5 N·m).

Storing a Flat -- Except Grand Sport Coupe Rear Tires or Spare Tire and Tools

CAUTION:

Storing a jack, a tire or other equipment in the passenger compartment of the vehicle could cause injury. In a sudden stop or collision, loose equipment could strike someone. Store all these in the proper place.

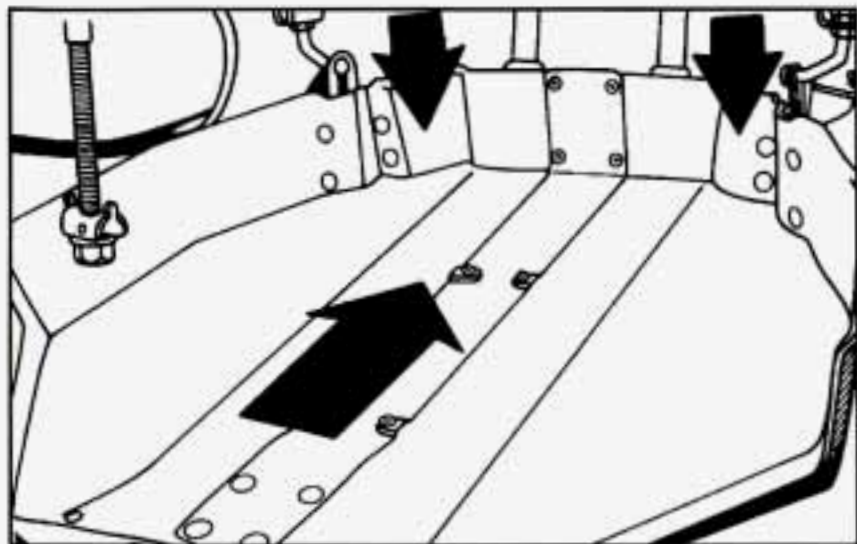

If your vehicle is equipped with a spare tire, the road tire is larger than the spare, so you must adjust the tray to its lower position. Lift and push the tire carrier tray toward the front of the vehicle. The tray will drop to its lower position.

If you are returning the spare to its storage area, raise the tire carrier tray to its upper position.

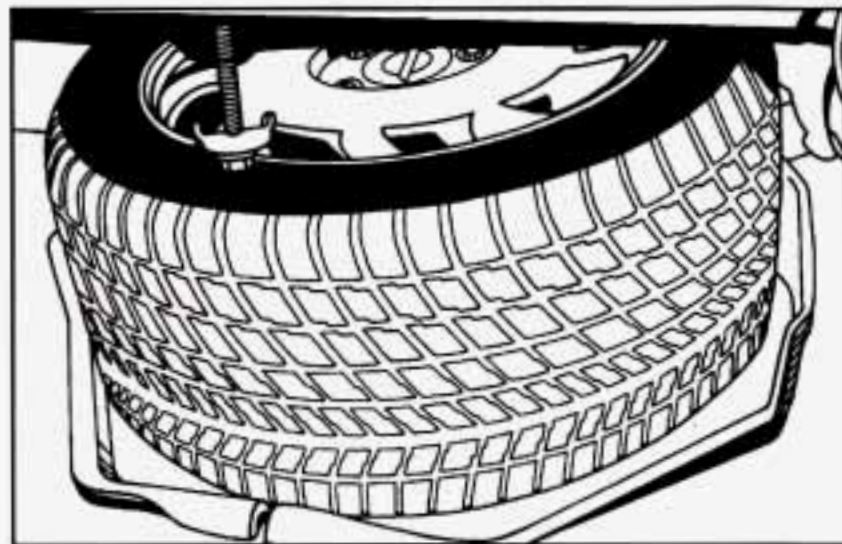

Put the tire on the tray. For the flat road tire, lift the latch bolt, pull it toward the rear of the vehicle, and the bolt will drop down to the lower position. For the spare tire, push up the latch bolt and push it toward the front of the vehicle to raise it to the upper position.

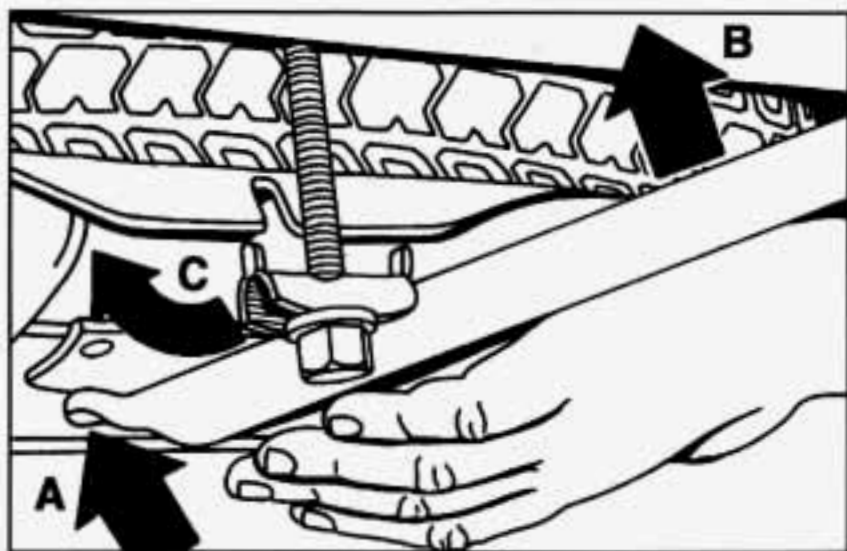

Put the hooked end of the wheel wrench into the slot in the tray (A). Lift the tray using the wheel wrench (B) and insert the latch bolt into the notch in the tray (C). To raise the tray, use the socket end of the wheel wrench to turn the latch bolt counterclockwise. Turn the latch bolt until it is snug.

Put the wheel wrench back in its place under the driver's seat. Be sure to tighten the wingnuts.

Put the jack, wheel nut socket and wheel lock key in the rear storage compartment behind the passenger's seat. Make sure the parts are stored properly in the foam container. Position the jack in the container so that you can read the yellow CAUTION label from the driver's seat. Replace the plastic tray and close the storage compartment.

NOTICE:

Your Corvette's radio receiver box is in the rear storage compartment. To help avoid damage, carefully place the jack, socket and wheel lock key into the foam container in the compartment. Do not toss or place the items against the radio receiver box or any wiring.

Storing a Flat Grand Sport Coupe Rear Tire and Tools

CAUTION:

Storing a jack or other equipment in the passenger compartment of the vehicle could cause injury. In a sudden stop or collision, loose equipment could strike someone. Store all these in the proper place.



A Grand Sport Coupe rear tire will not fit in the tray, so you must put it on the floor of the rear area. Put the flat tire in the storage bag provided with the spare. Place the tire on the rear area floor.

Use the luggage straps to hold the tire in place. Loosen the straps, then attach each end of the longer strap to the rear cargo hooks.

Attach the other strap to the hook behind the console.

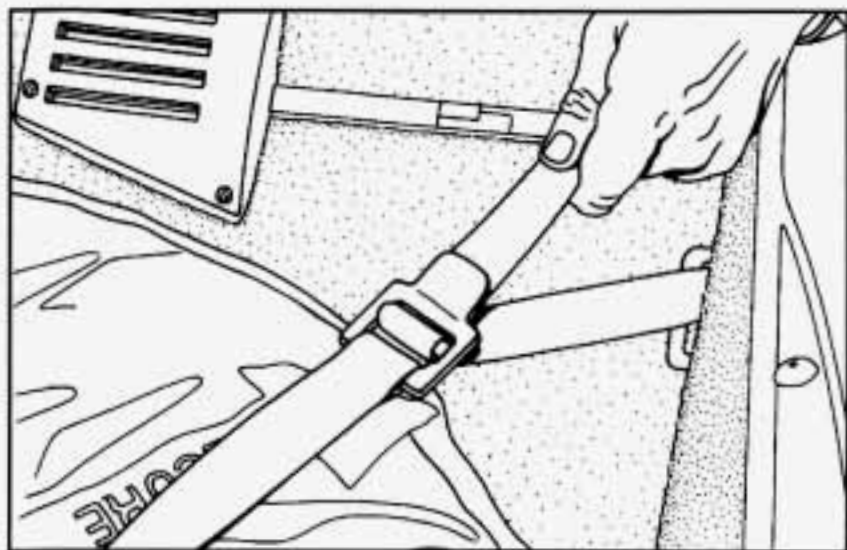

Raise the tire carrier tray to its upper position and tighten the latch bolt until it is snug.

⚠ CAUTION:

Do not place anything on top of the flat road tire when it is stored in the rear area. If you stop quickly, these things could fly forward into the passenger area and hurt someone. Secure any loose articles in the rear area.

When the tire is stored in the rear cargo area, you can't store a removable roof panel. It will not fit into the latches properly.

Put the wheel wrench back in its place under the driver's seat. Be sure to tighten the wingnuts.

Put the jack, wheel nut socket and wheel lock key in the rear storage compartment behind the passenger's seat. Make sure the parts are stored properly in the foam container. Position the jack in the container so that you can read the yellow CAUTION label from the driver's seat. Replace the plastic tray and close the storage compartment.

NOTICE:

Your Corvette's radio receiver box is in the rear storage compartment. To help avoid damage, carefully place the jack, socket and wheel lock key into the foam container in the compartment. Do not toss or place the items against the radio receiver box or any wiring.

Compact Spare Tire (If So Equipped)

Although the compact spare tire was fully inflated when your vehicle was new, it can lose air after a time. Check the inflation pressure regularly. It should be 60 psi (420 kPa).

After installing the compact spare on your vehicle, you should stop as soon as possible and make sure your spare tire is correctly inflated. The compact spare is made to perform well at posted speed limits for distances up to 3,000 miles (5 000 km), so you can finish your trip and have your full-size tire repaired or replaced where you want. Of course, it's best to replace your spare with a full-size tire as soon as you can. Your spare will last longer and be in good shape in case you need it again.

CAUTION:

When the compact spare is installed, your vehicle's handling capabilities will be reduced during severe maneuvers. If you drive too fast, you could lose control of your vehicle. You or others could be injured. Don't drive over 55 mph (90 km/h) when the compact spare is installed.

NOTICE:

When the compact spare is installed, don't take your vehicle through an automatic car wash with guide rails. The compact spare can get caught on the rails. That can damage the tire and wheel, and maybe other parts of your vehicle.

Don't use your compact spare on other vehicles.

And don't mix your compact spare tire or wheel with other wheels or tires. They won't fit. Keep your spare tire and its wheel together.

NOTICE:

Tire chains won't fit your compact spare. Using them can damage your car and can damage the chains too. Don't use tire chains on your compact spare.

If You're Stuck: In Sand, Mud, Ice or Snow

What you don't want to do when your vehicle is stuck is to spin your wheels too fast. The method known as "rocking" can help you get out when you're stuck, but you must use caution.



CAUTION:

If you let your tires spin at high speed, they can explode, and you or others could be injured. And, the transmission or other parts of the vehicle can overheat. That could cause an engine compartment fire or other damage. When you're stuck, spin the wheels as little as possible. Don't spin the wheels above 35 mph (55 km/h) as shown on the speedometer.

NOTICE:

Spinning your wheels can destroy parts of your vehicle as well as the tires. If you spin the wheels too fast while shifting your transmission back and forth, you can destroy your transmission.

For information about using tire chains on your vehicle, see "Tire Chains" in the Index.

Rocking Your Vehicle to Get it Out

First, turn your steering wheel left and right. That will clear the area around your front wheels. You should turn your ASR system off. (See "ASR System" in the Index.) Then shift back and forth between REVERSE (R) and a forward gear (or with a manual transmission, between FIRST (1) or SECOND (2) and REVERSE (R)), spinning the wheels as little as possible. Release the accelerator pedal while you shift, and press lightly on the accelerator pedal when the transmission is in gear. If that doesn't get you out after a few tries, you may need to be towed out. If you do need to be towed out, see "Towing Your Vehicle" in the Index.



Section 6 Service and Appearance Care

Here you will find information about the care of your Corvette. This section begins with service and fuel information, and then it shows how to check important fluid and lubricant levels. There is also technical information about your vehicle, and a part devoted to its appearance care.

Service

Your Corvette dealer knows your vehicle best and wants you to be happy with it. We hope you'll go to your dealer for all your service needs. You'll get genuine GM parts and GM-trained and supported service people.

We hope you'll want to keep your GM vehicle all GM. Genuine GM parts have one of these marks:



Doing Your Own Service Work

If you want to do some of your own service work, you'll want to get the proper Corvette Service Manual. It tells you much more about how to service your Corvette than this manual can. To order the proper service manual, see "Service and Owner Publications" in the Index.

Your vehicle has an air bag system. Before attempting to do your own service work, see "Servicing Your Air Bag-Equipped Corvette" in the Index.

You should keep a record with all parts receipts and list the mileage and the date of any service work you perform. See "Maintenance Record" in the Index.



CAUTION:

You can be injured and your vehicle could be damaged if you try to do service work on a vehicle without knowing enough about it.

- **Be sure you have sufficient knowledge, experience, and the proper replacement parts and tools before you attempt any vehicle maintenance task.**
- **Be sure to use the proper nuts, bolts and other fasteners. "English" and "metric" fasteners can be easily confused. If you use the wrong fasteners, parts can later break or fall off. You could be hurt.**

Fuel

If you have the 5.7L Code 5 engine, use premium unleaded gasoline rated at 91 octane or higher.

If you have the 5.7L Code P engine, use premium unleaded gasoline rated at 91 octane or higher for best performance. You may use middle grade or regular unleaded gasolines, but your vehicle may not accelerate as well.

At a minimum, the gasoline you use should meet specifications ASTM D4814 in the United States and CGSB 3.5-M93 in Canada. Improved gasoline specifications have been developed by the American Automobile Manufacturers Association (AAMA) for better vehicle performance and engine protection. Gasolines meeting the AAMA specification could provide improved driveability and emission control system protection compared to other gasolines.

Be sure the posted octane for premium is at least 91 (at least 89 for middle grade and 87 for regular). If the octane is less than 87, you may get a heavy knocking noise when you drive. If it's bad enough, it can damage your engine.

If you're using fuel rated at the recommended octane or higher and you still hear heavy knocking, your engine needs service. But don't worry if you hear a little pinging noise when you're accelerating or driving up a hill. That's normal, and you don't have to buy a higher octane fuel to get rid of pinging. It's the heavy, constant knock that means you have a problem.

If your vehicle is certified to meet California Emission Standards (indicated on the underhood tune-up label), it is designed to operate on fuels that meet California specifications. If such fuels are not available in states adopting California emissions standards, your vehicle will operate satisfactorily on fuels meeting federal specifications, but emission control system performance may be affected. The malfunction indicator lamp on your instrument panel may turn on and/or your vehicle may fail a smog-check test. If this occurs, return to your authorized Corvette dealer for diagnosis to determine the cause of failure. In the event it is determined that the cause of the condition is the type of fuels used, repairs may not be covered by your warranty.

In Canada, some gasolines contain an octane enhancing additive called MMT. If you use such fuels, your emission control system performance may deteriorate and the malfunction indicator lamp on your instrument panel may also turn on. If this happens, return to your authorized Corvette dealer for service.

To provide cleaner air, all gasolines are now required to contain additives that will help prevent deposits from forming in your engine and fuel system, allowing your emission control system to function properly. Therefore, you should not have to add anything to the fuel. In addition, gasolines containing oxygenates, such as ethers and ethanol, and reformulated gasolines may be available in your area to help clean the air. General Motors recommends that you use these gasolines if they comply with the specifications described earlier.

NOTICE:

Your vehicle was not designed for fuel that contains methanol. Don't use it. It can corrode metal parts in your fuel system and also damage plastic and rubber parts. That damage wouldn't be covered under your warranty.

Fuels in Foreign Countries

If you plan on driving in another country outside the United States or Canada, the proper fuel may be hard to find. Never use leaded gasoline or any other fuel not recommended in the previous text on fuel. Costly repairs caused by use of improper fuel wouldn't be covered by your warranty.

To check on fuel availability, ask an auto club, or contact a major oil company that does business in the country where you'll be driving.

You can also write us at the following address for advice. Just tell us where you're going and give your Vehicle Identification Number (VIN).

General Motors Overseas Distribution Corporation,
North American Export Sales (NAES)
1908 Colonel Sam Drive
Oshawa, Ontario L1H 8P7

Filling Your Tank



CAUTION:

Gasoline vapor is highly flammable. It burns violently, and that can cause very bad injuries. Don't smoke if you're near gasoline or refueling your vehicle. Keep sparks, flames, and smoking materials away from gasoline.

The cap is under a hinged door on the rear decklid of your vehicle.

While refueling, place the cap in the indent to the left of the filler neck.

To take off the cap, turn it slowly to the left (counterclockwise).

 **CAUTION:**

If you get gasoline on yourself and then something ignites it, you could be badly burned. Gasoline can spray out on you if you open the fuel filler cap too quickly. This spray can happen if your tank is nearly full, and is more likely in hot weather. Open the fuel filler cap slowly and wait for any “hiss” noise to stop. Then unscrew the cap all the way.

Be careful not to spill gasoline. Clean gasoline from painted surfaces as soon as possible. See “Cleaning the Outside of Your Corvette” in the Index.

When you put the cap back on, turn it to the right until you hear at least three clicks. Make sure you fully install the cap. The diagnostic system can determine if the fuel cap has been left off or improperly installed. This would allow fuel to evaporate into the atmosphere. See “Malfunction Indicator Lamp” in the Index.

NOTICE:

If you need a new cap, be sure to get the right type. Your dealer can get one for you. If you get the wrong type, it may not fit or have proper venting, and your fuel tank and emissions system might be damaged.

Checking Things Under the Hood

Hood Release



To open the hood, first pull the handle inside the vehicle.



Then go to the side of the vehicle and pull up on the rear edge of the hood, near the windshield.

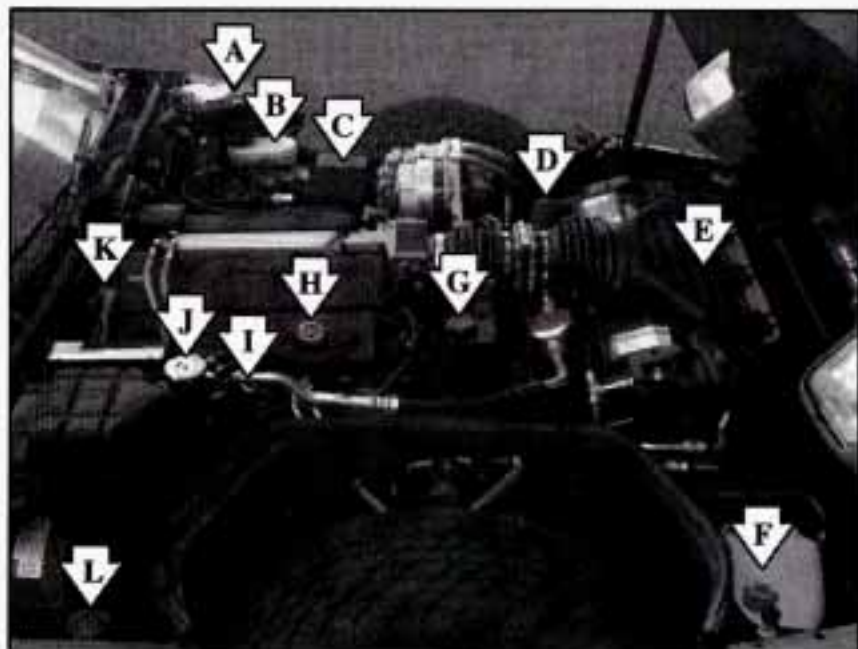

LT1 Engine Shown, LT4 Engine Similar

You'll see the following when you open the hood with the LT1 engine:

- A. Hydraulic Clutch Fluid Reservoir (if equipped)
- B. Brake Fluid Reservoir
- C. Battery
- D. Electric Engine Fan
- E. Air Cleaner
- F. Coolant Recovery Tank
- G. Power Steering Fluid Reservoir
- H. Engine Oil Fill Cap
- I. Engine Oil Dipstick
- J. Coolant High Fill Reservoir
- K. Automatic Transmission Dipstick (if equipped)
- L. Windshield Washer Fluid Reservoir

⚠ CAUTION:

An electric fan under the hood can start up and injure you even when the engine is not running. Keep hands, clothing and tools away from any underhood electric fan.

⚠ CAUTION:

Things that burn can get on hot engine parts and start a fire. These include liquids like gasoline, oil, coolant, brake fluid, windshield washer and other fluids, and plastic or rubber. You or others could be burned. Be careful not to drop or spill things that will burn onto a hot engine.

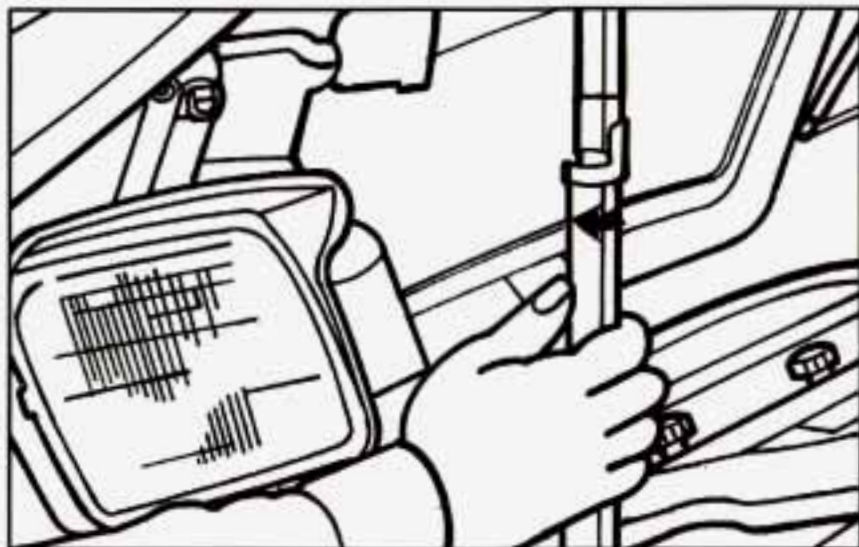

Then release the hood strut by moving it to the centered position and lowering the hood. Lower the hood until the bottom of the hood is the same height as the top of the windshield, then release it.

Before closing the hood, be sure all the filler caps are on.

Engine Oil

It's a good idea to check your engine oil level every time you get fuel. In order to get an accurate reading, the oil must be warm and the vehicle must be on level ground.



The engine oil dipstick is next to the coolant high fill reservoir. The dipstick handle is a round, yellow loop.

Turn off the engine and give the oil a few minutes to drain back into the oil pan. If you don't, the oil dipstick might not show the actual level.

Checking Engine Oil

Pull out the dipstick and clean it with a paper towel or a cloth, then push it back in all the way. Remove it again, keeping the tip down.

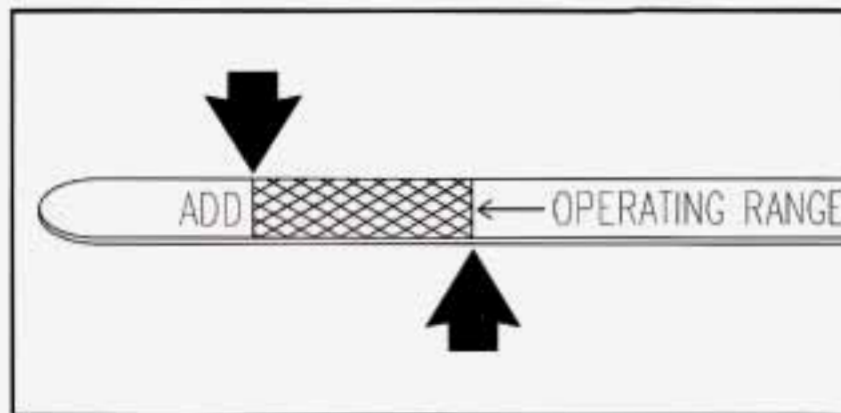

When to Add Oil

If the oil is at or below the ADD mark, you'll need to add some oil. But you must use the right kind. This part explains what kind of oil to use. For crankcase capacity, see "Capacities and Specifications" in the Index.

NOTICE:

Don't add too much oil. If your engine has so much oil that the oil level gets above the upper mark that shows the proper operating range, your engine could be damaged.



The engine oil fill cap is on top of the engine block.

Just fill it enough to put the level somewhere in the proper operating range. Push the dipstick all the way back in when you're through.

What Kind of Oil to Use

Look for two things:

- GM4718M

The Corvette engine requires a special oil meeting GM Standard GM4718M. Oils meeting this Standard may be identified as synthetic. However, not all *synthetic* oils will meet this GM Standard. You should look for and use only an oil that meets GM Standard GM4718M.



NOTICE:

If you use oils that don't have the GM4718M Standard designation, you can cause engine damage not covered by your warranty.

RECOMMENDED SAE VISCOSITY GRADE ENGINE OILS

FOR BEST FUEL ECONOMY AND COLD STARTING, SELECT THE LOWEST SAE VISCOSITY GRADE OIL FOR THE EXPECTED TEMPERATURE RANGE.

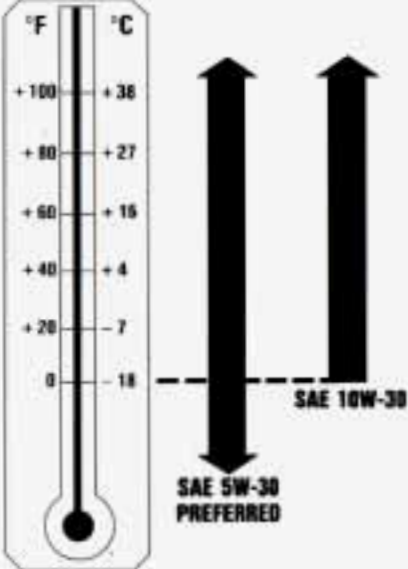
LOOK FOR THIS SYMBOL



HOT WEATHER

COLD WEATHER

DO NOT USE SAE 20W-50 OR ANY OTHER GRADE OIL NOT RECOMMENDED

- SAE 5W-30

As shown in the viscosity chart, SAE 5W-30 is best for your vehicle. However, you can use SAE 10W-30 if it's going to be 0°F (-18°C) or above.

These numbers on an oil container show its viscosity, or thickness. Do not use other viscosity oils such as SAE 20W-50.



Oils meeting these requirements should also have the "Starburst" symbol on the container. This symbol indicates that the oil has been certified by the American Petroleum Institute (API). Do not use any oil which does not carry this Starburst symbol.

You should look for this on the oil container, and use *only* those oils that are identified as meeting GM Standard GM4718M and have the Starburst symbol on the front of the oil container.

Your Corvette engine is filled at the factory with a Mobil 1[®] synthetic oil, which meets all requirements for your vehicle.

Substitute Oil: When adding oil to maintain engine oil level, oil meeting GM Standard GM4718M may not be available. You can add substitute oil designated SAE 5W-30 with the "Starburst" symbol at all temperatures. If temperatures are above 0°F (-18°C), you may substitute SAE 10W-30 with the "Starburst" symbol. Substitute oil not meeting GM Standard GM4718M should not be used for an oil change.

Engine Oil Additives

Don't add anything to your oil. Your Corvette dealer is ready to advise if you think something should be added.

When to Change Engine Oil

If any one of these is true for you, use the short trip/city maintenance schedule:

- Most trips are less than 5 to 10 miles (8 to 16 km). This is particularly important when outside temperatures are below freezing.
- Most trips include extensive idling (such as frequent driving in stop-and-go traffic).
- Most trips are through dusty areas.

Driving under these conditions causes engine oil to break down sooner. If any one of these is true for your vehicle, you need to change your oil and filter every 3,000 miles (5 000 km) or 3 months -- whichever occurs first.

If none of them is true, use the long trip/highway maintenance schedule. Change the oil and filter every 7,500 miles (12 500 km) or 12 months -- whichever occurs first. Driving a vehicle with a fully warmed engine under highway conditions causes engine oil to break down slower.

Your Corvette has an Oil Life Monitor. This feature will let you know when to change your oil and filter -- usually between 3,000 miles (5 000 km) and 7,500 miles (12 500 km) since your last oil change. Under severe conditions, the indicator may come on before 3,000 miles

(5 000 km). Never drive your vehicle more than 7,500 miles (12 500 km) or 12 months (whichever occurs first) without an oil change.

The system won't detect dust in the oil. So, if you drive in a dusty area, be sure to change your oil every 3,000 miles (5 000 km) or sooner if the CHANGE OIL light comes on. Remember to reset the monitor when the oil has been changed. For more information, see "Engine Oil Life Monitor" in the Index.

What to Do with Used Oil

Did you know that used engine oil contains certain elements that may be unhealthy for your skin and could even cause cancer? Don't let used oil stay on your skin for very long. Clean your skin and nails with soap and water, or a good hand cleaner. Wash or throw away clothing or rags containing used engine oil. (See the manufacturer's warnings about the use and disposal of oil products.)

Used oil can be a real threat to the environment. If you change your own oil, be sure to drain all free-flowing oil from the filter before disposal. Don't ever dispose of oil by putting it in the trash, pouring it on the ground, into sewers, or into streams or bodies of water. Instead, recycle it by taking it to a place that collects used oil. If you have a problem properly disposing of your used oil, ask your dealer, a service station or a local recycling center for help.

Air Cleaner



Refer to the Maintenance Schedule to determine when to replace the air filter.

See “Scheduled Maintenance Services” in the Index.

CAUTION:

Operating the engine with the air cleaner off can cause you or others to be burned. The air cleaner not only cleans the air, it stops flame if the engine backfires. If it isn't there, and the engine backfires, you could be burned. Don't drive with it off, and be careful working on the engine with the air cleaner off.

NOTICE:

If the air cleaner is off, a backfire can cause a damaging engine fire. And, dirt can easily get into your engine, which will damage it. Always have the air cleaner in place when you're driving.

Air Filter Replacement

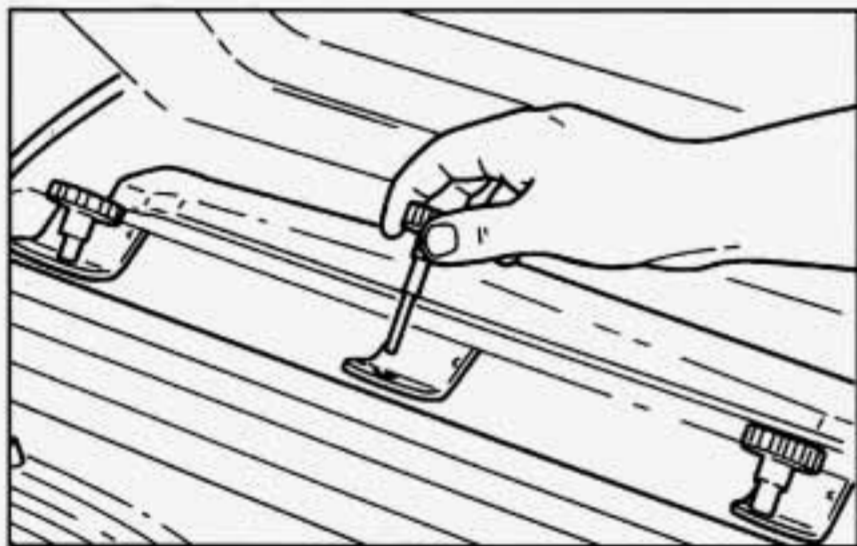

To remove the air filter:

1. Unscrew the three knobs.

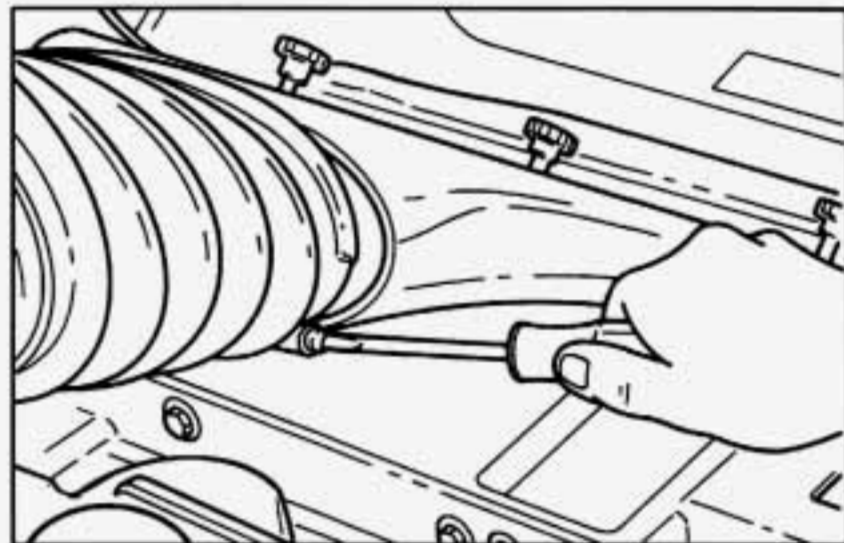

2. Disconnect the clamp from the manifold.

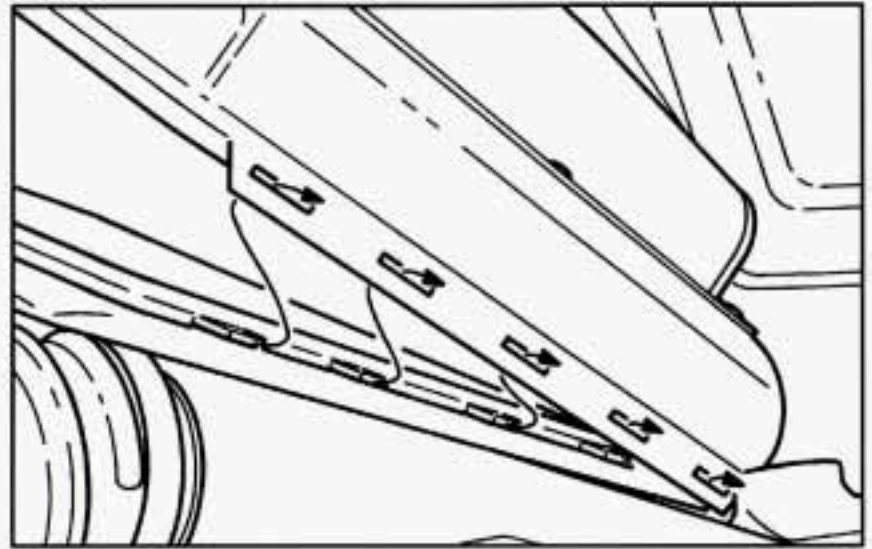

3. Pull the air cleaner straight up.
4. Open the air cleaner to remove the old filter and install the new one.

5. Reverse the steps.
 - Align the tabs to the slots in the bottom of the assembly before you replace it.
 - Install the short knob into the middle hole first. Then install the longer knobs into the outer holes.

Automatic Transmission Fluid

When to Check and Change

A good time to check your automatic transmission fluid level is when the engine oil is changed.

Change both the fluid and filter every 15,000 miles (25 000 km) if the vehicle is mainly driven under one or more of these conditions:

- In heavy city traffic where the outside temperature regularly reaches 90°F (32°C) or higher.
- In hilly or mountainous terrain.
- Uses such as found in taxi, police or delivery service.

If you do not use your vehicle under any of these conditions, change the fluid and filter at 100,000 miles (166 000 km).

See “Scheduled Maintenance Services” in the Index.

How to Check

Because this operation can be a little difficult, you may choose to have this done at your Corvette dealership Service Department.

If you do it yourself, be sure to follow all the instructions here, or you could get a false reading on the dipstick.

NOTICE:

Too much or too little fluid can damage your transmission. Too much can mean that some of the fluid could come out and fall on hot engine parts or exhaust system parts, starting a fire. Be sure to get an accurate reading if you check your transmission fluid.

Wait at least 30 minutes before checking the transmission fluid level if you have been driving:

- When outside temperatures are above 90°F (32°C).
- At high speed for quite a while.
- In heavy traffic -- especially in hot weather.

To get the right reading, the fluid should be at normal operating temperature, which is 180°F to 200°F (82°C to 93°C).

Checking Transmission Fluid Hot

Get the vehicle warmed up by driving about 15 miles (24 km) when outside temperatures are above 50°F (10°C). You may have to drive longer to bring the fluid to 180°F to 200°F (82°C to 93°C) in colder outside temperatures. See “Automatic Transmission Fluid Temperature Reading” in the Index.

Checking Transmission Fluid Cold

A cold check is made after the vehicle has been sitting for eight hours or more with the engine off and is used only as a reference. Let the engine run at idle for five minutes if outside temperatures are 50°F (10°C) or more. If it's colder than 50°F (10°C), you may have to idle the engine longer. Should the fluid level be low during a cold check, you *must* perform a hot check before adding fluid. This will give you a more accurate reading of the fluid level.

Checking the Fluid Hot or Cold

- Park your vehicle on a level place. Keep the engine running.
- With the parking brake applied, place the shift lever in PARK (P).
- With your foot on the brake pedal, move the shift lever through each gear range, pausing for about three seconds in each range. Then, position the shift lever in PARK (P).
- Let the engine run at idle for three minutes or more.

Then, without shutting off the engine, follow these steps:



1. The automatic transmission fluid dipstick is behind the engine oil dipstick, near the windshield. The dipstick handle is a round, red loop. Pull out the dipstick and wipe it with a clean rag or paper towel.

2. Push it back in all the way, wait three seconds and then pull it back out again.

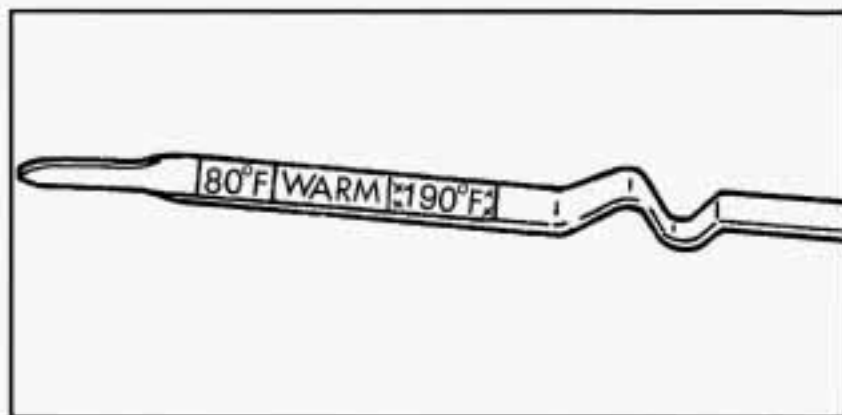

3. Check both sides of the dipstick, and read the lower level. The fluid level should be in the area marked "80°F" for a cold check and will move into the "WARM" area as the temperature increases. When the fluid is at normal operating temperature (180°F to 200°F, 82°C to 93°C), the level must be in the crosshatched area marked "190°F." See "Automatic Transmission Fluid Temperature Reading" in the Index.
4. If the fluid level is in the acceptable range, push the dipstick back in all the way.

How to Add Fluid

Refer to the Maintenance Schedule to determine what kind of transmission fluid to use. See “Recommended Fluids and Lubricants” in the Index.

Add fluid only after checking the transmission fluid HOT. (A COLD check is used only as a reference.) If the fluid level is low, add only enough of the proper fluid to bring the level up to the HOT area for a hot check. It doesn't take much fluid, generally less than a pint (0.5 L). *Don't overfill.* We recommend you use only fluid labeled DEXRON®-III, because fluid with that label is made especially for your automatic transmission. Damage caused by fluid other than DEXRON-III is not covered by your new vehicle warranty.

- After adding fluid, recheck the fluid level as described under “How to Check.”
- When the correct fluid level is obtained, push the dipstick back in all the way.

Manual Transmission Fluid

When to Check

A good time to have it checked is when the engine oil is changed. However, the fluid in your manual transmission doesn't require changing.

How to Check

Because this operation can be difficult, you may choose to have this done at your Corvette dealership Service Department.

If you do it yourself, be sure to follow all the instructions here, or you could get a false reading.

NOTICE:

Too much or too little fluid can damage your transmission. Too much can mean that some of the fluid could come out and fall on hot engine parts or exhaust system parts, starting a fire. Be sure to get an accurate reading if you check your transmission fluid.

Check the fluid level only when your engine is off, the vehicle is parked on a level place and the transmission is cool enough for you to rest your fingers on the transmission case.

Then, follow these steps:

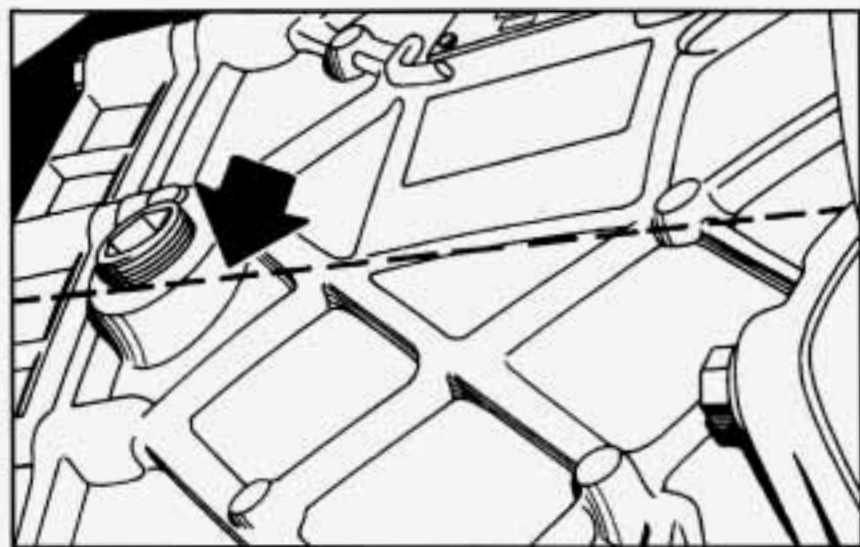

1. Remove the filler plug.
2. Check that the lubricant level is up to the bottom of the filler plug hole.
3. If the fluid level is good, install the plug and be sure it is fully seated. If the fluid level is low, add more fluid as described in the next steps.

How to Add Fluid

Here's how to add fluid. Refer to the Maintenance Schedule to determine what kind of fluid to use. See "Recommended Fluids and Lubricants" in the Index.

1. Remove the filler plug.
2. Add fluid at the filler plug hole. Add only enough fluid to bring the fluid level up to the bottom of the filler plug hole.
3. Install the filler plug. Be sure the plug is fully seated.

Hydraulic Clutch

The clutch linkage in your vehicle is self-adjusting. The clutch master cylinder reservoir is filled with hydraulic clutch fluid.

It isn't a good idea to "top off" your clutch fluid. Adding fluid won't correct a leak.

A fluid loss in this system could indicate a problem. Have the system inspected and repaired.

When to Check and What to Use

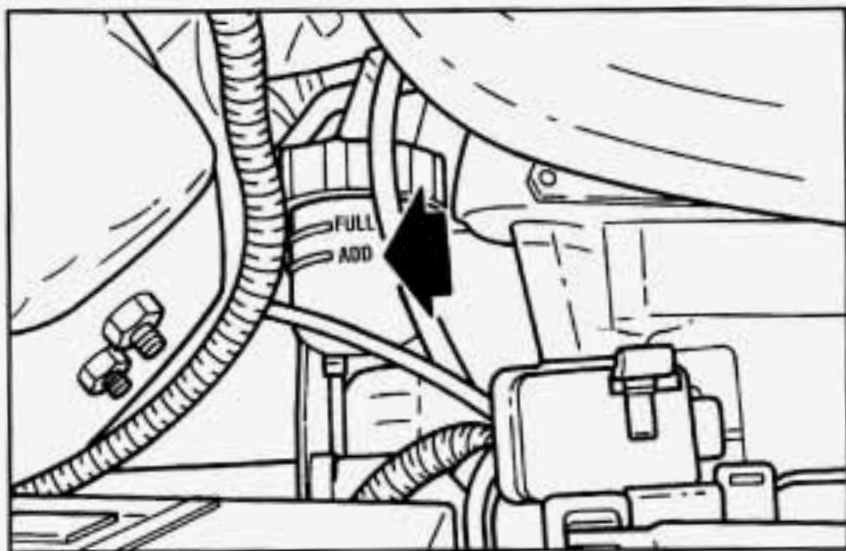

Refer to the Maintenance Schedule to determine how often you should check the fluid level in your clutch master cylinder reservoir and for the proper fluid. See "Owner Checks and Services" and "Recommended Fluids and Lubricants" in the Index.

How To Check and Add Fluid

The clutch master cylinder is under the Powertrain Control Module (PCM) in the left rear area of the engine compartment.

To check the fluid, look at the area between the PCM and the battery.

To add fluid, remove the PCM unit.



You must loosen and remove the two screws before the PCM unit will lift out.

Fluid should be added if the fluid level is at or below the ADD mark on the reservoir. There are additional instructions on the reservoir cap.

When returning the PCM to its proper position, make sure the unit is fully rearward in the bracket prior to installing the two screws.

Rear Axle

When to Check Lubricant

Refer to the Maintenance Schedule to determine how often to check the lubricant. See "Periodic Maintenance Inspections" in the Index.

How to Check Lubricant



If the level is below the bottom of the filler plug hole, you'll need to add some lubricant. Add enough lubricant to raise the level to the bottom of the filler plug hole.

What to Use

To add lubricant when the level is low, use Axle Lubricant (GM Part No. 12345977) or SAE 80W-90 GL-5 gear lubricant. To completely refill after draining, add 4 ounces (118 ml) of Limited-Slip Differential Lubricant Additive (GM Part No. 1052358). Then fill to the bottom of the filler plug hole with Axle Lubricant (GM Part No. 12345977) or SAE 80W-90 GL-5 gear lubricant.

Engine Coolant

The cooling system in your vehicle is filled with new DEX-COOL™ (orange-colored, silicate-free) engine coolant. This coolant is designed to remain in your vehicle for 5 years or 100,000 miles (166 000 km), whichever occurs first.

The following explains your cooling system and how to add coolant when it is low. If you have a problem with engine overheating or if you need to add coolant to your high fill reservoir, see “Engine Overheating” in the Index.

A 50/50 mixture of water and the proper coolant for your Corvette will:

- Give freezing protection down to -34°F (-37°C).
- Give boiling protection up to 265°F (129°C).
- Protect against rust and corrosion.
- Help keep the proper engine temperature.
- Let the warning lights and gauges work as they should.

NOTICE:

When adding coolant it is important that you use DEX-COOL™ (orange-colored, silicate-free) coolant meeting GM Specification 6277M.

If *silicated* coolant is added to the system, premature engine, heater core or radiator corrosion may result. In addition, the engine coolant will require change sooner -- at 30,000 miles (50 000 km) or 24 months, whichever occurs first.

What to Use

Use a mixture of one-half *clean water* (preferably distilled) and one-half DEX-COOL™ (orange-colored, silicate-free) antifreeze that meets GM Specification 6277M, which won't damage aluminum parts. Use GM Engine Coolant Supplement (sealer) (GM Part No. 3634621) with any complete coolant change. If you use this mixture, you don't need to add anything else.

CAUTION:

Adding only plain water to your cooling system can be dangerous. Plain water, or some other liquid like alcohol, can boil before the proper coolant mix will. Your vehicle's coolant warning system is set for the proper coolant mix. With plain water or the wrong mix, your engine could get too hot but you wouldn't get the overheat warning. Your engine could catch fire and you or others could be burned. Use a 50/50 mix of clean water and DEX-COOL™ (orange-colored, silicate-free) antifreeze.

NOTICE:

If you use an improper coolant mix, your engine could overheat and be badly damaged. The repair cost wouldn't be covered by your warranty. Too much water in the mix can freeze and crack the engine, radiator, heater core and other parts.

If you have to add coolant more than four times a year, have your dealer check your cooling system.

NOTICE:

If you use the proper coolant, you don't have to add extra inhibitors or additives which claim to improve the system. These can be harmful.

Checking Coolant

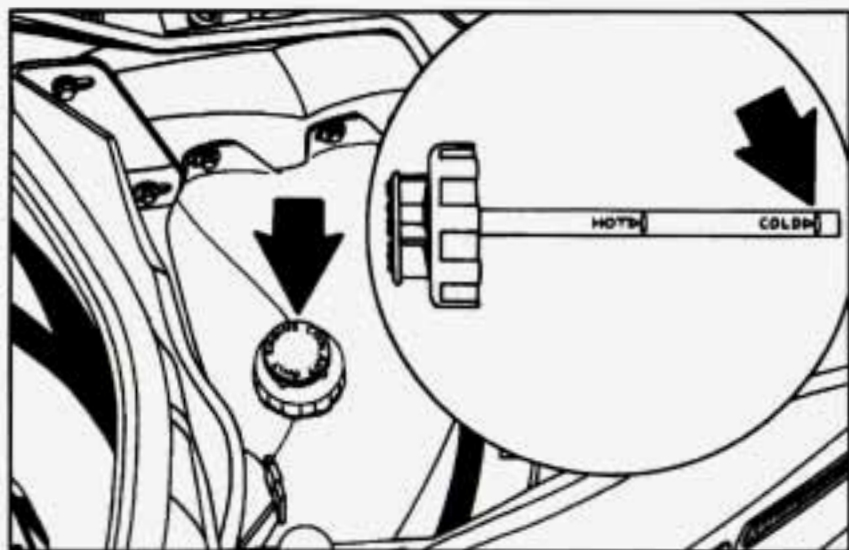

When your engine is cold, check the dipstick on the cap of the coolant recovery tank. The coolant level should be at COLD, or a little higher. When your engine is warm, the level on the dipstick should be up to HOT, or a little higher.

LOW
COOLANT

If this light comes on, it means you're low on engine coolant.

Your Corvette also has a high fill reservoir located at the right rear of the engine compartment.

If the recovery tank is very low or empty, also add coolant to the high fill reservoir. To add coolant at the high fill reservoir, see "Engine Overheating" in the Index.

Adding Coolant to the Recovery Tank

If you need more coolant, add the proper mix *at the coolant recovery tank*, but only when your engine is cool. If the tank is very low or empty, also add coolant to the coolant high fill reservoir. See "Engine Overheating" in the Index for information.

CAUTION:

Turning the coolant high fill reservoir pressure cap when the engine and radiator are hot can allow steam and scalding liquids to blow out and burn you badly. Never turn the pressure cap -- even a little -- when the engine and radiator are hot.

Add coolant mix at the recovery tank, but be careful not to spill it.

CAUTION:

You can be burned if you spill coolant on hot engine parts. Coolant contains ethylene glycol, and it will burn if the engine parts are hot enough. Don't spill coolant on a hot engine.

For complete drain, flush and refill of the engine, contact your Chevrolet dealer or the procedure may be found in a Chevrolet Corvette Service Manual. To purchase a service manual, see "Service and Owner Publications" in the Index.

Coolant High Fill Reservoir Cap

NOTICE:

Your coolant high fill reservoir cap is a 15 psi (105 kPa) pressure-type cap and must be tightly installed to prevent coolant loss and possible engine damage from overheating. Be sure the arrows on the cap line up with the overflow tube.

Thermostat

Engine coolant temperature is controlled by a thermostat in the engine coolant system. The thermostat stops the flow of coolant through the radiator until the coolant reaches a pre-set temperature.

Power Steering Fluid



When to Check Power Steering Fluid

It is not necessary to regularly check power steering fluid unless you suspect there is a leak in the system or you hear an unusual noise. A fluid loss in this system could indicate a problem. Have the system inspected and repaired.

How To Check Power Steering Fluid

When the engine compartment is cool, unscrew the cap and wipe the dipstick with a clean rag. Replace the cap and completely tighten it. Then remove the cap again and look at the fluid level on the dipstick.

The level should be at the FULL COLD mark. If necessary, add only enough fluid to bring the level up to the mark.

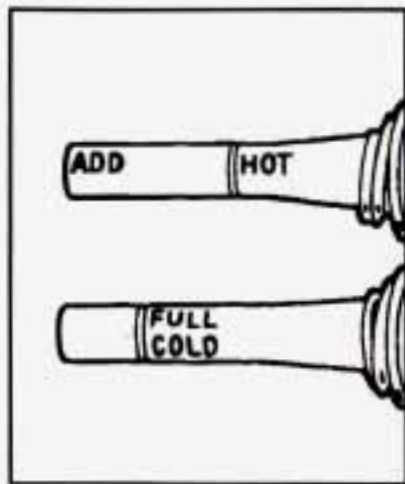

- When the engine compartment is hot the level should be at the HOT mark.
- When the engine compartment is cool, the level should be at the FULL COLD mark.

What to Use

Refer to the Maintenance Schedule to determine what kind of fluid to use. See "Recommended Fluids and Lubricants" in the Index. Always use the proper fluid. Failure to use the proper fluid can cause leaks and damage hoses and seals.

Windshield Washer Fluid

What to Use

When you need windshield washer fluid, be sure to read the manufacturer's instructions before use. If you will be operating your vehicle in an area where the temperature may fall below freezing, use a fluid that has sufficient protection against freezing.

Adding Washer Fluid



Open the cap labeled **WASHER FLUID ONLY**. Add washer fluid until the tank is full.

NOTICE:

- When using concentrated washer fluid, follow the manufacturer's instructions for adding water.
- Don't mix water with ready-to-use washer fluid. Water can cause the solution to freeze and damage your washer fluid tank and other parts of the washer system. Also, water doesn't clean as well as washer fluid.
- Fill your washer fluid tank only three-quarters full when it's very cold. This allows for expansion, which could damage the tank if it is completely full.
- Don't use radiator antifreeze in your windshield washer. It can damage your washer system and paint.

Brakes

Brake Fluid



Your brake master cylinder reservoir is here. It is filled with DOT-3 brake fluid.

There are only two reasons why the brake fluid level in the reservoir might go down. The first is that the brake fluid goes down to an acceptable level during normal brake lining wear. When new linings are put in, the fluid level goes back up. The other reason is that fluid is leaking out of the brake system. If it is, you should have your brake system fixed, since a leak means that sooner or later your brakes won't work well, or won't work at all.

So, it isn't a good idea to "top off" your brake fluid. Adding brake fluid won't correct a leak. If you add fluid when your linings are worn, then you'll have too much fluid when you get new brake linings. You should add (or remove) brake fluid, as necessary, only when work is done on the brake hydraulic system.



CAUTION:

If you have too much brake fluid, it can spill on the engine. The fluid will burn if the engine is hot enough. You or others could be burned, and your vehicle could be damaged. Add brake fluid only when work is done on the brake hydraulic system.

Refer to the Maintenance Schedule to determine when to check your brake fluid. See "Periodic Maintenance Inspections" in the Index.

Checking Brake Fluid

You can check the brake fluid without taking off the cap. Just look at the brake fluid reservoir. The fluid level should be above the MIN mark on the reservoir. If it isn't, have your brake system checked to see if there is a leak.

After work is done on the brake hydraulic system, make sure the level is between the MIN and MAX marks.

What to Add

When you do need brake fluid, use only DOT-3 brake fluid -- such as Delco Supreme 11[®] (GM Part No. 1052535). Use new brake fluid from a sealed container only, and always clean the brake fluid reservoir cap before removing it.

CAUTION:

With the wrong kind of fluid in your brake system, your brakes may not work well, or they may not even work at all. This could cause a crash. Always use the proper brake fluid.

NOTICE:

- **Using the wrong fluid can badly damage brake system parts. For example, just a few drops of mineral-based oil, such as engine oil, in your brake system can damage brake system parts so badly that they'll have to be replaced. Don't let someone put in the wrong kind of fluid.**
- **If you spill brake fluid on your vehicle's painted surfaces, the paint finish can be damaged. Be careful not to spill brake fluid on your vehicle. If you do, wash it off immediately. See "Appearance Care" in the Index.**

Brake Wear

Your Corvette has four-wheel disc brakes.

Disc brake pads have built-in wear indicators that make a high-pitched warning sound when the brake pads are worn and new pads are needed. The sound may come and go or be heard all the time your vehicle is moving (except when you are pushing on the brake pedal firmly).

CAUTION:

The brake wear warning sound means that sooner or later your brakes won't work well. That could lead to an accident. When you hear the brake wear warning sound, have your vehicle serviced.

NOTICE:

Continuing to drive with worn-out brake pads could result in costly brake repair.

Some driving conditions or climates may cause a brake squeal when the brakes are first applied or lightly applied. This does not mean something is wrong with your brakes.

Brake linings should always be replaced as complete axle sets.

Brake Pedal Travel

See your dealer if the brake pedal does not return to normal height, or if there is a rapid increase in pedal travel. This could be a sign of brake trouble.

Brake Adjustment

As you make brake stops, your disc brakes automatically adjust for wear.

Replacing Brake System Parts

The braking system on a modern vehicle is complex. Its many parts have to be of top quality and work well together if the vehicle is to have really good braking. Vehicles we design and test have top-quality GM brake parts in them, as your Corvette does when it is new. When you replace parts of your braking system -- for example, when your brake linings wear down and you have to have new ones put in -- be sure you get new genuine GM replacement parts. If you don't, your brakes may no longer work properly. For example, if someone puts in brake linings that are wrong for your vehicle, the balance between your front and rear brakes can change -- for the worse. The braking performance you've come to expect can change in many other ways if someone puts in the wrong replacement brake parts.

Battery

Every new Corvette has a Delco Freedom[®] battery. You never have to add water to one of these. When it's time for a new battery, we recommend a Delco Freedom battery. Get one that has the replacement number shown on the original battery's label. For battery replacement, see your dealer or the Corvette Service Manual. To purchase a service manual, see "Service and Owner Publications" in the Index.

Vehicle Storage

If you're not going to drive your vehicle for 25 days or more, take off the black, negative (-) cable from the battery. This will help keep your battery from running down.



CAUTION:

Batteries have acid that can burn you and gas that can explode. You can be badly hurt if you aren't careful. See "Jump Starting" in the Index for tips on working around a battery without getting hurt.

Contact your dealer to learn how to prepare your vehicle for longer storage periods.

Bulb Replacement

For the proper type of replacement bulb, see “Replacement Bulbs” in the Index.

Halogen Bulbs

CAUTION:

Halogen bulbs have pressurized gas inside and can burst if you drop or scratch the bulb. You or others could be injured. Be sure to read and follow the instructions on the bulb package.

Headlamps

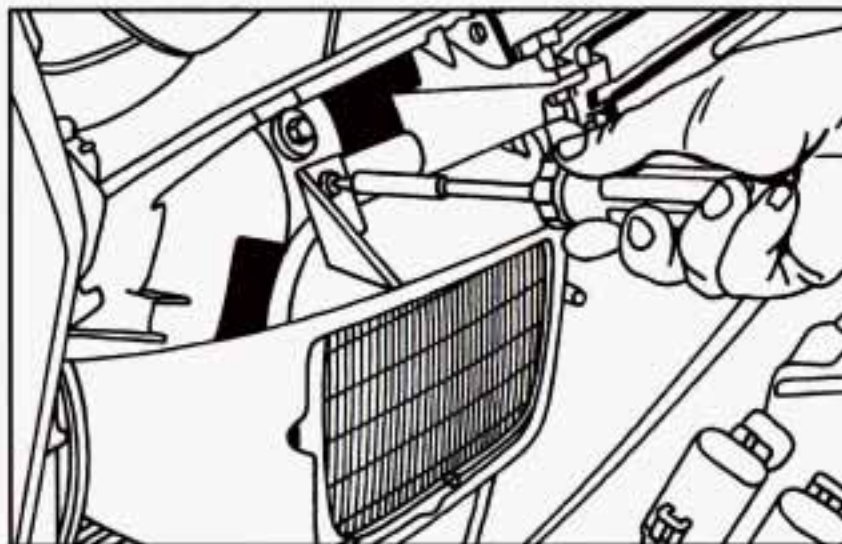

1. Open the hood.
2. The headlamps need to be halfway open. Turn the headlamp switch on, then quickly back to the parking lamps setting. You may have to do this a few times to get the half-open position. You can also open the headlamps manually. See “Headlamp Doors” in the Index.
3. Remove the two screws on each side of the headlamp.

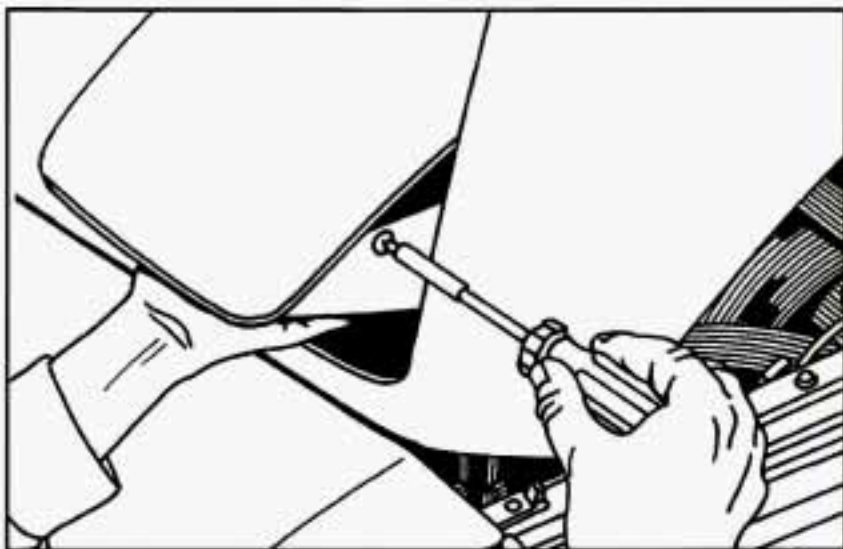

4. Remove the two screws from both sides of the cover. Before you remove the last screw, put your hand under the cover to hold it.
5. Reach around the hood and pull the cover straight out. Be careful not to scratch the paint.

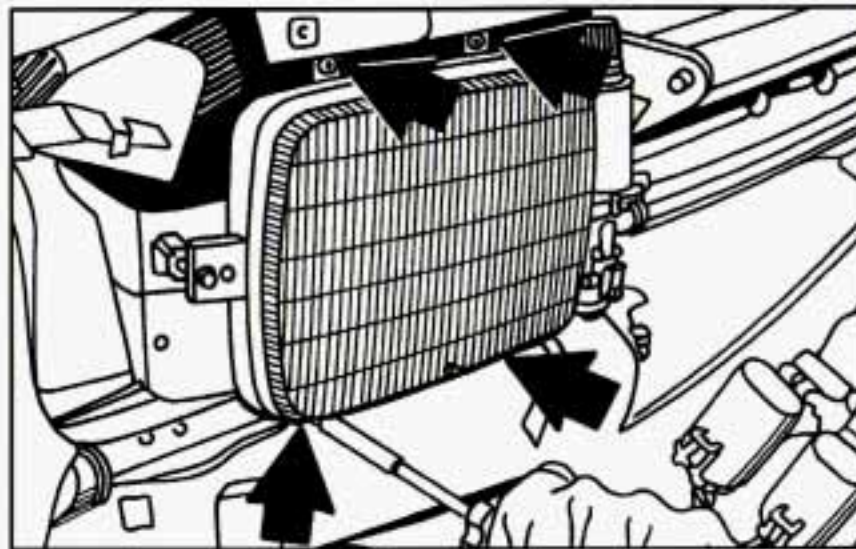

6. Remove the four screws from the retainer near each corner of the headlamp. Don't move the large-head adjusting screws or your headlamp will not be aimed properly.
Hold the headlamp and remove the retainer.
7. Remove the headlamp and unplug the electrical connector.
8. Reverse the steps with a new headlamp.

Front Turn Signal Lamps

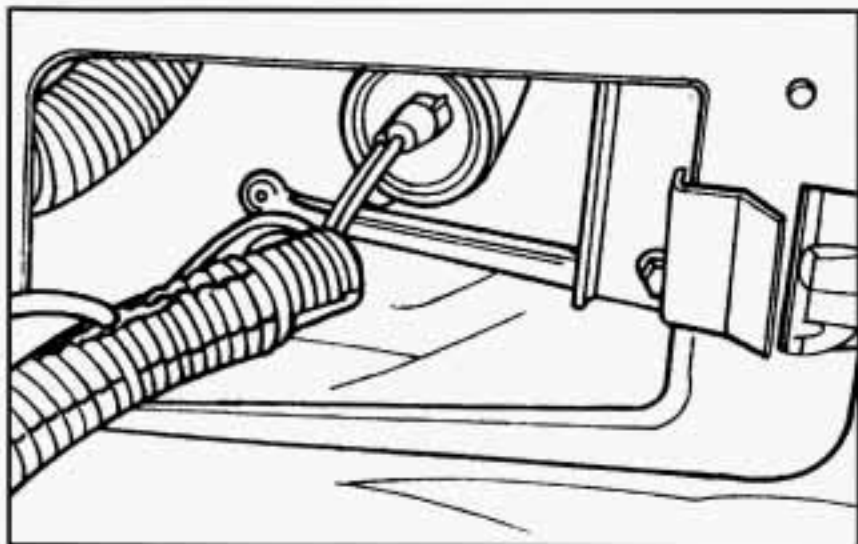

1. Open the hood.
2. Find the socket at the front of the engine compartment.
3. Turn the socket counterclockwise one-quarter of a turn and pull it out.

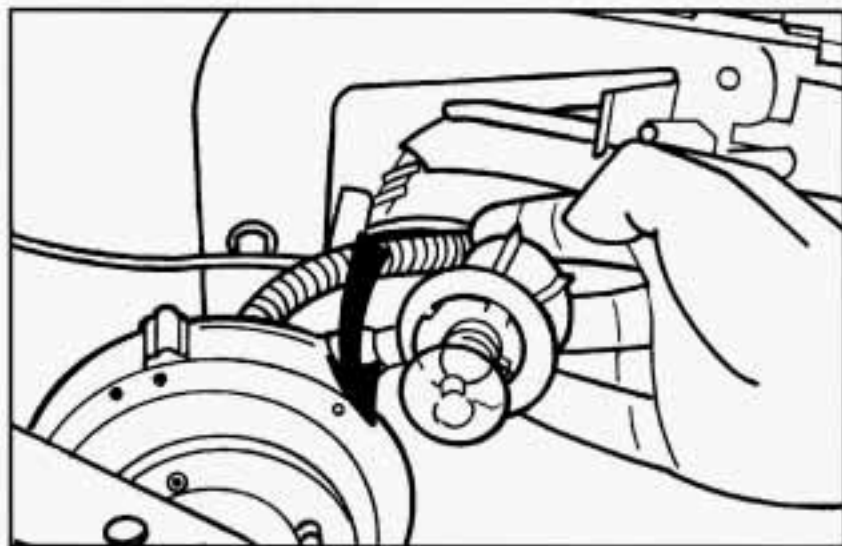

4. Push the bulb in, turn it counterclockwise, then pull it out.
5. Reverse the steps with a new bulb. The socket has three large tabs and one small tab. Be sure to line up the small tab with the small notch in the housing.

Sidemarker Lamps

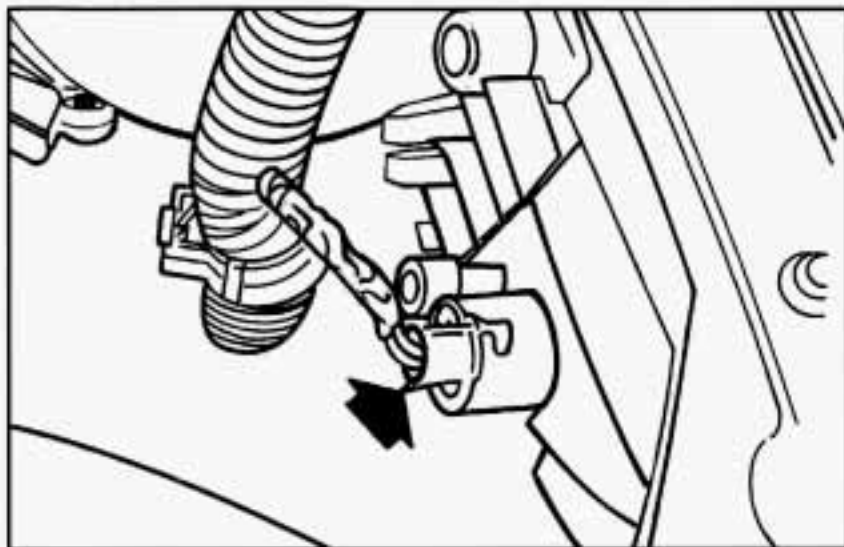

You can reach the front sidemarker lamp from inside the engine compartment.

Reach the rear sidemarker lamp from under the vehicle.

1. Turn the socket counterclockwise one-quarter of a turn and pull it out.

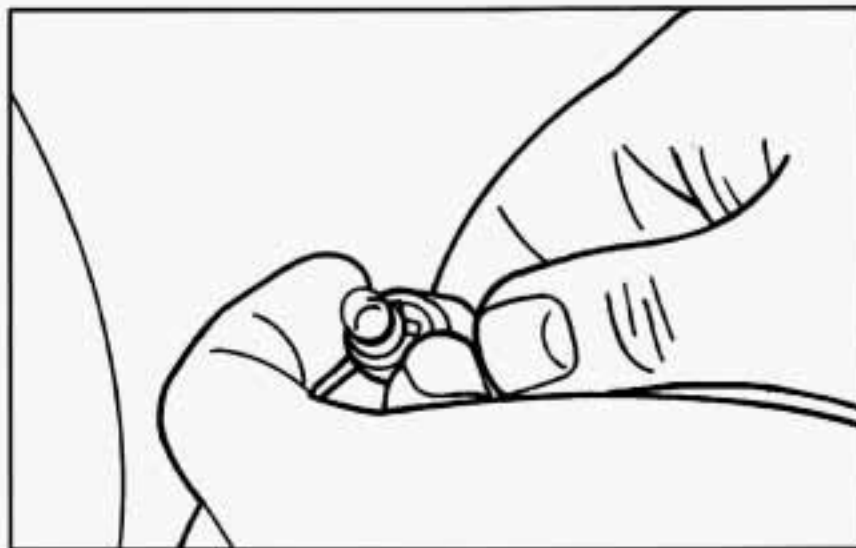

2. Pull the bulb straight out.
3. Reverse the steps with a new bulb.

Cornering Lamps

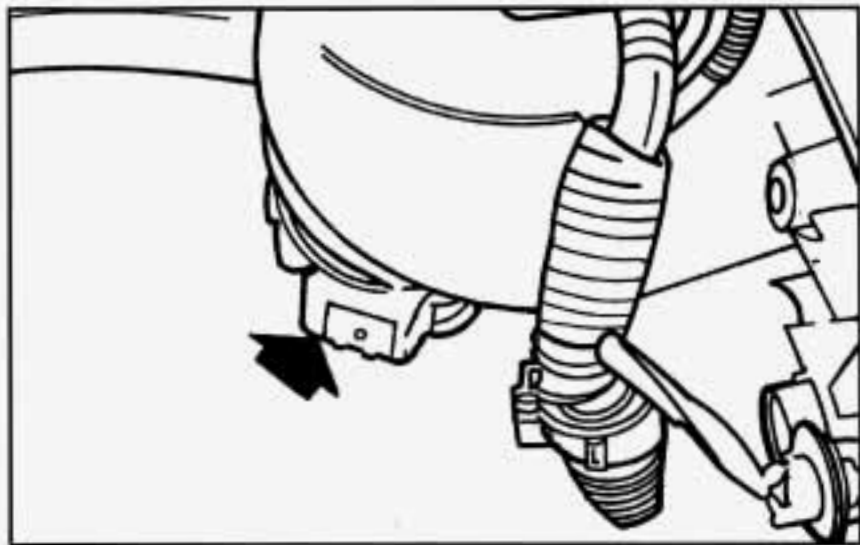

You can reach the front cornering lamp from inside the engine compartment.

Reach the rear cornering lamp from under the vehicle.

1. Press the tab on the socket, turn it counterclockwise one-quarter of a turn and pull it out.

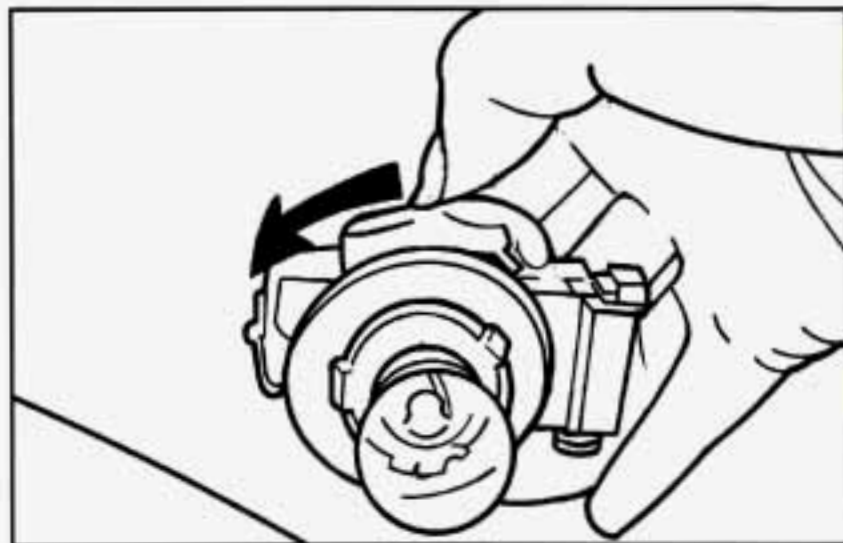

2. Push the bulb in, turn it counterclockwise, then pull it out.
3. Reverse the steps with a new bulb.

Fog Lamps

You can reach the fog lamps from under the front bumper.

1. Remove the screw in the access door. Open the door.
2. Turn the bulb base counterclockwise one-eighth of a turn and pull it out.
3. Disconnect the bulb base from the wiring harness.
4. Reverse the steps with a new bulb.

Center High-Mounted Stoplamp

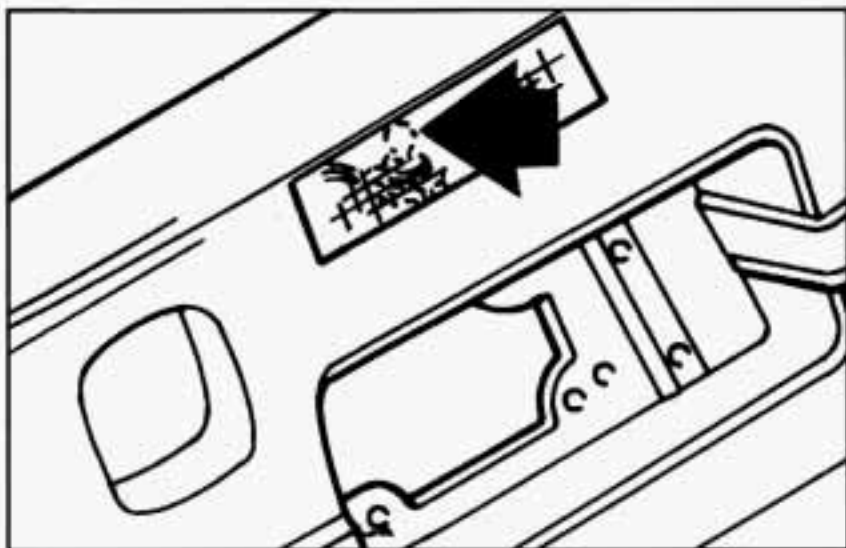

You can reach the center high-mounted stoplamp by removing the license plate and reaching through the opening.

1. Turn the socket counterclockwise one-quarter of a turn and pull it out.

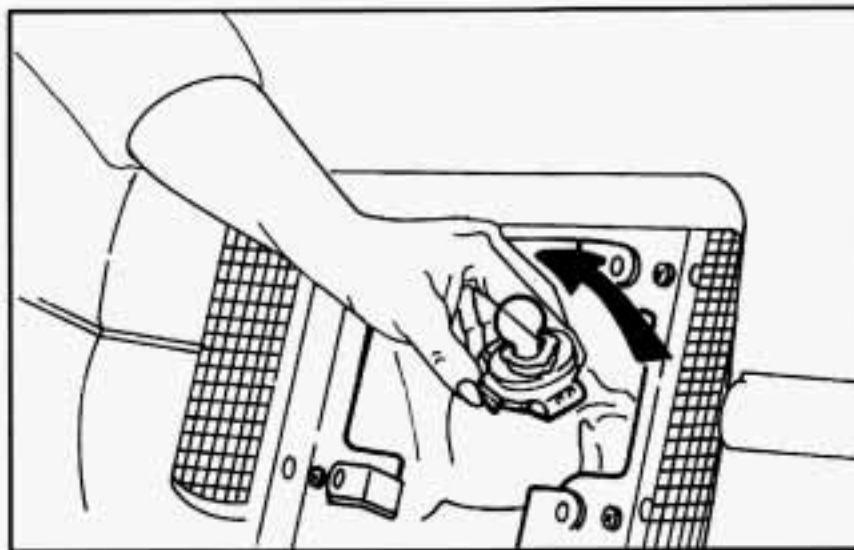

2. Push the bulb in, turn it counterclockwise, then pull it out.
3. Reverse the steps with a new bulb.

Rear Turn Signal and Taillamps

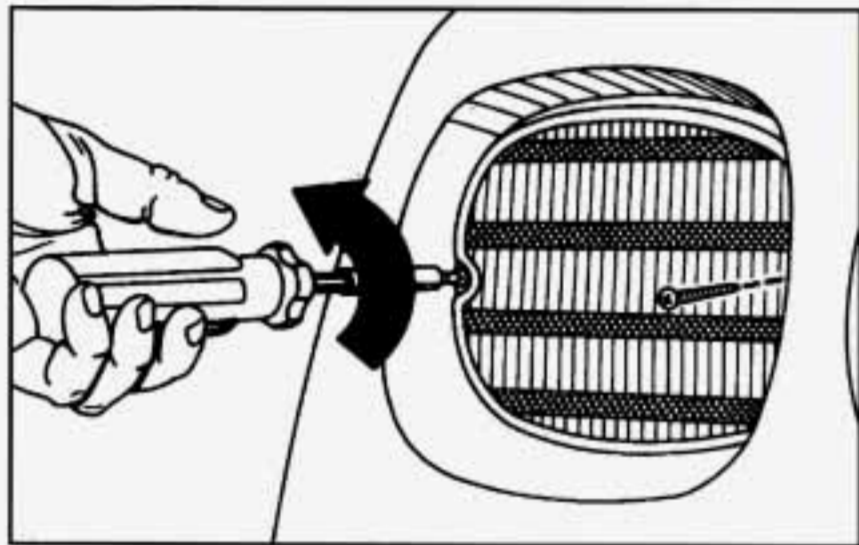

1. Remove the screws.

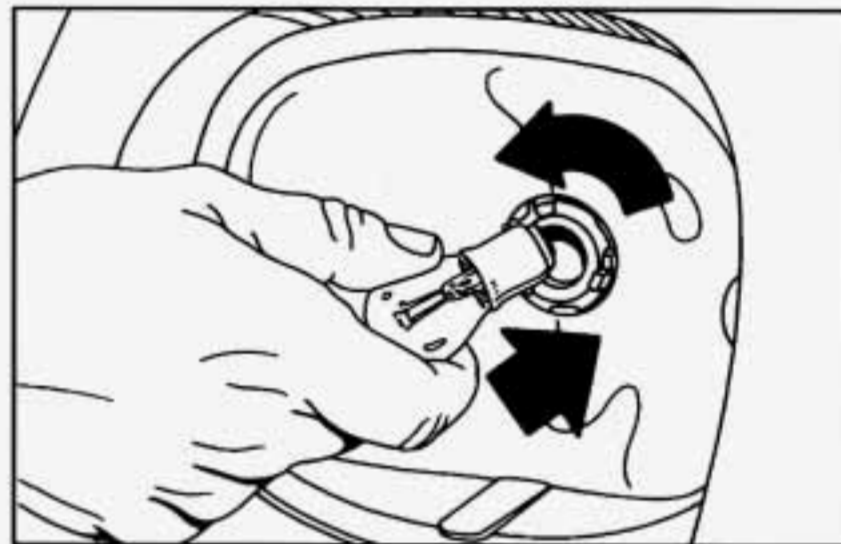

2. Pull the lens out.
3. Push the bulb in, turn it counterclockwise, then pull it out.
4. Reverse the steps with a new bulb. To prevent water from getting inside the lens, make sure the lens seal is properly positioned.

Back-up Lamps

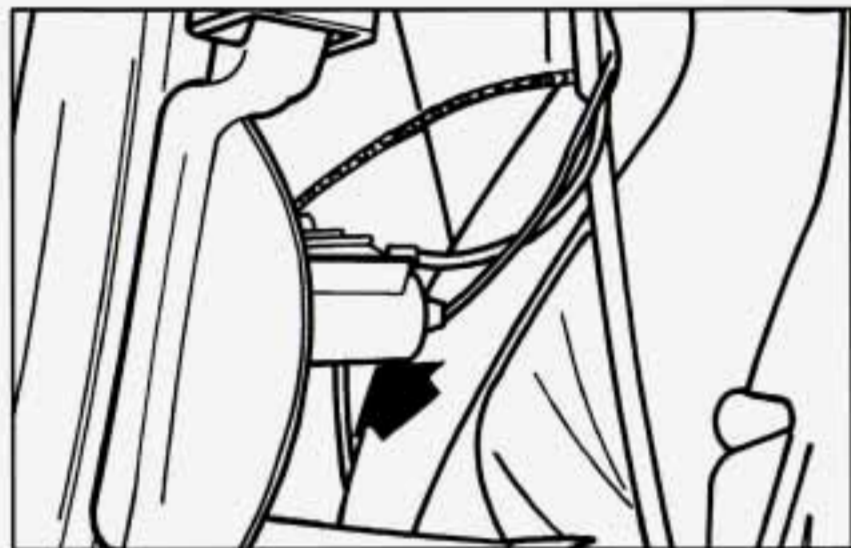

You can reach the back-up lamps by removing the license plate and reaching through the opening.

1. Push the tab on the socket and turn it counterclockwise.

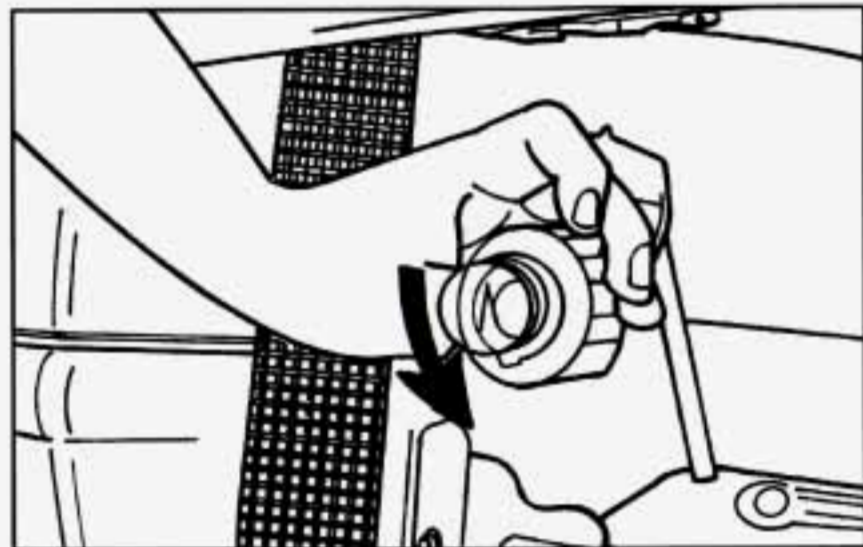

2. Push the bulb in, turn it counterclockwise, then pull it out.
3. Reverse the steps with a new bulb.

Rear Cargo Compartment Lamp -- Coupe

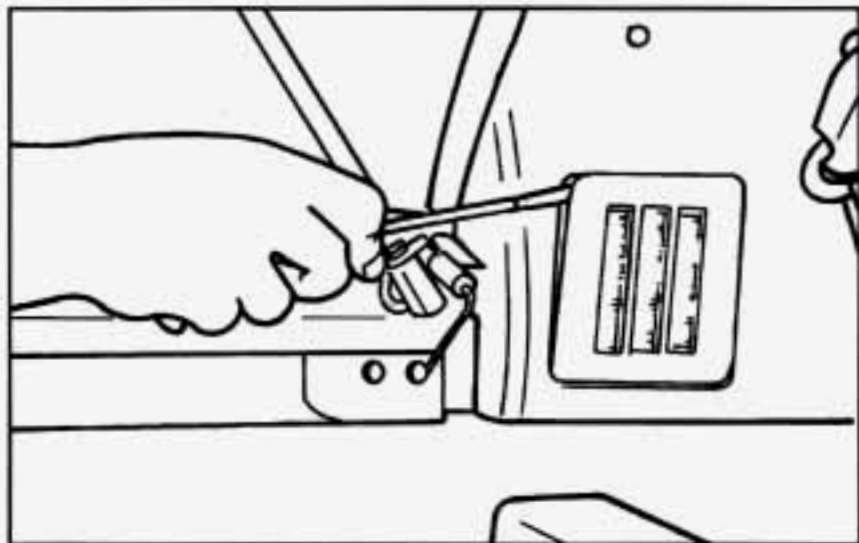

1. Pry the cover off with a screwdriver. Be sure to pry from the rear side, or you could break the tab on the cover.

2. Remove the bulb.
3. Reverse the steps with a new bulb.

Rear Cargo Compartment Lamp -- Convertible

1. Pry the cover off with a screwdriver.
2. Remove the bulb.
3. Reverse the steps with a new bulb.

Windshield Wiper Blade Replacement

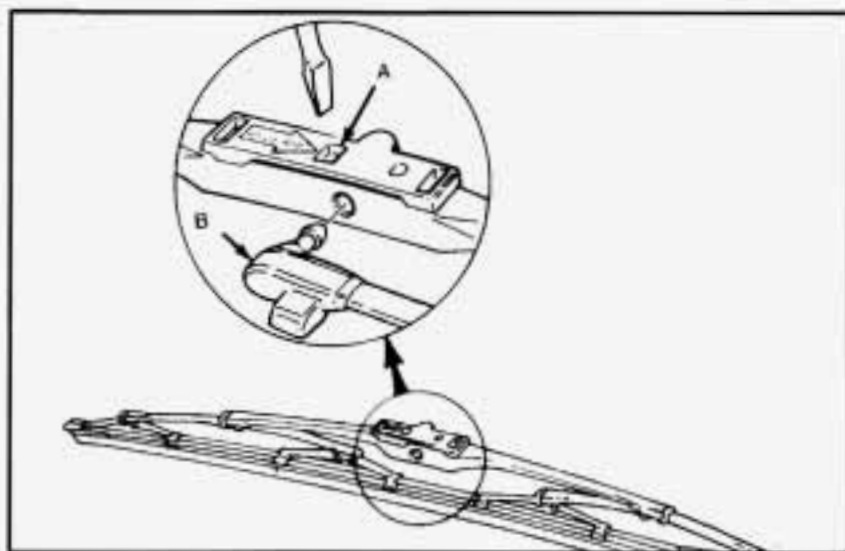

It's a good idea to clean or replace the wiper blade assembly every six months. For the proper windshield wiper blade length and type, see "Replacement Parts" in the Index. To remove the wiper blade assembly:

1. Open the hood to gain access to the windshield wipers.
2. Insert a screwdriver into the release slot (A) on the wiper arm. (There's an arrow on the wiper arm pointing to the slot.)
3. Push down gently to release the wiper blade assembly (B) from the arm.
4. Reverse the steps to install the new assembly.

Tires

We don't make tires. Your new Corvette comes with high-quality tires made by a leading tire manufacturer. If you ever have questions about your tire warranty and where to obtain service, see your Corvette Warranty booklet for details.



CAUTION:

Poorly maintained and improperly used tires are dangerous.

- **Overloading your tires can cause overheating as a result of too much friction. You could have an air-out and a serious accident. See "Loading Your Vehicle" in the Index.**

CAUTION: (Continued)

CAUTION: (Continued)

- **Underinflated tires pose the same danger as overloaded tires. The resulting accident could cause serious injury. Check all tires frequently to maintain the recommended pressure. Tire pressure should be checked when your tires are cold.**
- **Overinflated tires are more likely to be cut, punctured or broken by a sudden impact -- such as when you hit a pothole. Keep tires at the recommended pressure.**
- **Worn, old tires can cause accidents. If your tread is badly worn, or if your tires have been damaged, replace them.**

See "Inflation -- Tire Pressure" in this section for the correct inflation pressure for competitive or high-speed driving.

Extended Mobility Tires (Option)

If your Corvette has optional Goodyear Extended Mobility Tires (EMT's), the tires will have "EMT" molded on the sidewalls. Your vehicle may also have a spare tire delete option. With the spare tire delete option, there's no spare tire, no tire changing equipment and no place to store a tire in the vehicle. Extended Mobility Tires perform so well without any air that a Low Tire Pressure Warning System (LTPWS) is used to alert you if a tire has lost pressure. A LOW/FLAT TIRE light will appear on your Driver Information Center if a tire's inflation pressure is less than 25 psi (170 kPa). If the LOW/FLAT TIRE light comes on, check your tire pressures as soon as you can. See "Low Tire Pressure Warning Light" in the Index for additional information.



CAUTION:

When the LOW/FLAT TIRE warning light is on, your vehicle's handling capabilities will be reduced during severe maneuvers. If you drive too fast, you could lose control of your vehicle. You or others could be injured. Don't drive over 55 mph (90 km/h) when the LOW/FLAT TIRE warning light is on. Drive cautiously, and check your tire pressures as soon as you can.

If a tire goes flat, you won't need to stop on the side of the road to change the tire. You can just keep on driving. The shorter the distance you drive and the slower the speed, the greater the chance that the tire will not have to be replaced. If you drive on a deflated EMT for distances of 50 miles (80 km) or less and at speeds of 55 mph (90 km/h) or less, there is a good chance that the tire can be repaired. The tire can operate effectively with no air pressure for up to 200 miles (320 km) at speeds up to 55 mph (90 km/h), but the tire would then have to be replaced. Also remember: When a tire is filled with air, it provides a cushion between the road and the wheel. Because you do not have this cushion when driving on a deflated tire, try to avoid potholes that could damage your wheel and require replacement of it.

Some road hazards can damage a tire beyond repair. This damage could occur before you've driven on the tire in a deflated condition. Whenever a tire has been damaged, or if you've driven any distance on a deflated EMT, check with a Goodyear EMT Service Center to determine whether the tire can be repaired or should be replaced. To maintain your vehicle's extended mobility feature, all replacement tires must be Extended Mobility Tires.

See the Goodyear Extended Mobility Tire Owner's Manual and Limited Warranty supplied with your Corvette for additional information.

Inflation -- Tire Pressure

The Tire-Loading Information label, which is on the rear edge of the driver's door, shows the correct inflation pressures for your tires when they're cold. "Cold" means your vehicle has been sitting for at least three hours or driven no more than 1 mile (1.6 km).

For competitive driving or high-speed driving (over 150 mph or 240 km/h), make sure your tires are inflated to 35 psi (240 kPa). When you end this type of driving, reduce the cold inflation pressures (if necessary) to those listed on the Tire-Loading Information label.

NOTICE:

Don't let anyone tell you that underinflation or overinflation is all right. It's not. If your tires don't have enough air (underinflation), you can get the following:

- Too much flexing
- Too much heat
- Tire overloading
- Bad wear
- Bad handling
- Bad fuel economy.

NOTICE: (Continued)

NOTICE: (Continued)

If your tires have too much air (overinflation), you can get the following:

- Unusual wear
- Bad handling
- Rough ride
- Needless damage from road hazards.

When to Check

Check your tires once a month or more.

If you have a compact spare tire, it should be at 60 psi (420 kPa).

How to Check

Use a good quality pocket-type gage to check tire pressure. You can't tell if your tires are properly inflated simply by looking at them. Radial tires may look properly inflated even when they're underinflated.

Be sure to put the valve caps back on the valve stems. They help prevent leaks by keeping out dirt and moisture.

Tire Rotation

The tires on your Corvette are directional, asymmetrical and are different sizes front to rear. Due to this, your tires should not be rotated. Each tire and wheel should be used only in the position it is in.

When It's Time for New Tires

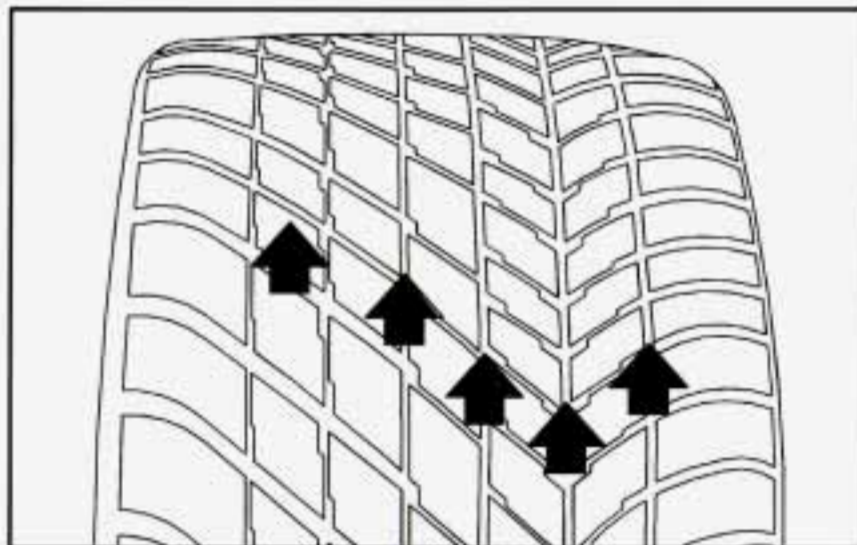

One way to tell when it's time for new tires is to check the treadwear indicators, which will appear when your tires have only 1/16 inch (1.6 mm) or less of tread remaining.

You need a new tire if any of the following statements are true:

- You can see the indicators at three or more places around the tire.
- You can see cord or fabric showing through the tire's rubber.
- The tread or sidewall is cracked, cut or snagged deep enough to show cord or fabric.
- The tire has a bump, bulge or split.
- The tire has a puncture, cut or other damage that can't be repaired well because of the size or location of the damage.

Buying New Tires

To find out what kind and size of tires you need, look at the Tire-Loading Information label.

The tires installed on your vehicle when it was new had a Tire Performance Criteria Specification (TPC Spec) number on each tire's sidewall. When you get new tires, get ones with that same TPC Spec number. That way your vehicle will continue to have tires that are designed to give proper endurance, handling, speed rating, traction, ride and other things during normal service on

your vehicle. If your tires have an all-season tread design, the TPC number will be followed by an "MS" (for mud and snow).

If you ever replace your tires with those not having a TPC Spec number, make sure they are the same size, load range, speed rating and construction type (bias, bias-belted or radial) as your original tires.

CAUTION:

Mixing tires could cause you to lose control while driving. If you mix tires of different sizes (other than those originally installed on your Corvette) or types (radial and bias-belted tires), the vehicle may not handle properly, and you could have a crash. Using tires of different sizes (other than those originally installed on your Corvette) may also cause damage to your vehicle. Be sure to use the correct size and type tires on all four wheels. It's all right to drive with your compact spare (if you have one). It was developed for use on your vehicle.

Uniform Tire Quality Grading

The following information relates to the system developed by the United States National Highway Traffic Safety Administration, which grades tires by treadwear, traction and temperature performance. (This applies only to vehicles sold in the United States.) The grades are molded on the sidewalls of most passenger car tires. The Uniform Tire Quality Grading system does not apply to deep tread, winter-type snow tires, space-saver or temporary use spare tires, tires with nominal rim diameters of 10 to 12 inches (25 to 30 cm), or to some limited-production tires.

While the tires available on General Motors passenger cars and light trucks may vary with respect to these grades, they must also conform to Federal safety requirements and additional General Motors Tire Performance Criteria (TPC) standards.

Treadwear

The treadwear grade is a comparative rating based on the wear rate of the tire when tested under controlled conditions on a specified government test course. For example, a tire graded 150 would wear one and a half (1 1/2) times as well on the government course as a tire graded 100. The relative performance of tires depends

upon the actual conditions of their use, however, and may depart significantly from the norm due to variations in driving habits, service practices and differences in road characteristics and climate.

Traction - A, B, C

The traction grades, from highest to lowest, are A, B, and C, and they represent the tire's ability to stop on wet pavement as measured under controlled conditions on specified government test surfaces of asphalt and concrete. A tire marked C may have poor traction performance.

Warning: The traction grade assigned to this tire is based on braking (straightahead) traction tests and does not include cornering (turning) traction.

Temperature - A, B, C

The temperature grades are A (the highest), B, and C, representing the tire's resistance to the generation of heat and its ability to dissipate heat when tested under controlled conditions on a specified indoor laboratory test wheel. Sustained high temperature can cause the material of the tire to degenerate and reduce tire life, and excessive temperature can lead to sudden tire failure. The grade C corresponds to a level of performance which all passenger car tires must meet under the Federal Motor Vehicle Safety Standard No. 109.

Grades B and A represent higher levels of performance on the laboratory test wheel than the minimum required by law.

Warning: The temperature grade for this tire is established for a tire that is properly inflated and not overloaded. Excessive speed, underinflation, or excessive loading, either separately or in combination, can cause heat buildup and possible tire failure.

Wheel Alignment and Tire Balance

The wheels on your vehicle were aligned and balanced carefully at the factory to give you the longest tire life and best overall performance.

In most cases, you will not need to have your wheels aligned again. However, if you notice unusual tire wear or your vehicle pulling one way or the other, the alignment may need to be reset. If you notice your vehicle vibrating when driving on a smooth road, your wheels may need to be rebalanced.

Wheel Replacement

Replace any wheel that is bent, cracked, or badly rusted or corroded. If wheel nuts keep coming loose, the wheel, wheel bolts and wheel nuts should be replaced. If the wheel leaks air, replace it (except some aluminum wheels, which can sometimes be repaired). See your Corvette dealer if any of these conditions exist.

Your dealer will know the kind of wheel you need.

Each new wheel should have the same load-carrying capacity, diameter, width, offset and be mounted the same way as the one it replaces.

If you need to replace any of your wheels, wheel bolts or wheel nuts, replace them only with new GM original equipment parts. This way, you will be sure to have the right wheel, wheel bolts and wheel nuts for your Corvette model.

 **CAUTION:**

Using the wrong replacement wheels, wheel bolts or wheel nuts on your vehicle can be dangerous. It could affect the braking and handling of your vehicle, make your tires lose air and make you lose control. You could have a collision in which you or others could be injured. Always use the correct wheel, wheel bolts and wheel nuts for replacement.

NOTICE:

The wrong wheel can also cause problems with bearing life, brake cooling, speedometer/odometer calibration, headlamp aim, bumper height, vehicle ground clearance and tire clearance to the body and chassis.

See “Changing a Flat Tire” in the Index for more information.

Used Replacement Wheels

 **CAUTION:**

Putting a used wheel on your vehicle is dangerous. You can't know how it's been used or how many miles it's been driven. It could fail suddenly and cause an accident. If you have to replace a wheel, use a new GM original equipment wheel.

Tire Chains

NOTICE:

Don't use tire chains. They can damage your vehicle.

Appearance Care

Remember, cleaning products can be hazardous. Some are toxic. Others can burst into flame if you strike a match or get them on a hot part of the vehicle. Some are dangerous if you breathe their fumes in a closed space. When you use anything from a container to clean your Corvette, be sure to follow the manufacturer's warnings and instructions. And always open your doors or windows when you're cleaning the inside.

Never use these to clean your vehicle:

- Gasoline
- Benzene
- Naphtha
- Carbon Tetrachloride
- Acetone
- Paint Thinner
- Turpentine
- Lacquer Thinner
- Nail Polish Remover

They can all be hazardous -- some more than others -- and they can all damage your vehicle, too.

Don't use any of these unless this manual says you can. In many uses, these will damage your vehicle:

- Alcohol
- Laundry Soap
- Bleach
- Reducing Agents

Cleaning the Inside of Your Corvette

Use a vacuum cleaner often to get rid of dust and loose dirt. Wipe vinyl or leather with a clean, damp cloth.

Your Corvette dealer has two GM cleaners, a solvent-type spot lifter and a foam-type powdered cleaner. They will clean normal spots and stains very well. Do not use them on vinyl or leather.

Here are some cleaning tips:

- Always read the instructions on the cleaner label.
- Clean up stains as soon as you can -- before they set.
- Use a clean cloth or sponge, and change to a clean area often. A soft brush may be used if stains are stubborn.
- Use solvent-type cleaners in a well-ventilated area only. If you use them, don't saturate the stained area.

- If a ring forms after spot cleaning, clean the entire area immediately or it will set.

Fabric Protection

Your Corvette has carpet that has been treated with Scotchgard™ Fabric Protector, a 3M product. It protects fabrics by repelling oil and water, which are the carriers of most stains. Even with this protection, you still need to clean your carpet often to keep it looking new.

Further information on cleaning is available by calling 1-800-433-3296 (in Minnesota, 1-800-642-6167).

Cleaning Vinyl

Use warm water and a clean cloth.

- Rub with a clean, damp cloth to remove dirt. You may have to do it more than once.
- Things like tar, asphalt and shoe polish will stain if you don't get them off quickly. Use a clean cloth and a GM Vinyl/Leather Cleaner or equivalent product.

Cleaning Coated Moldings

These moldings are around the hatch opening in your Corvette's rear area.

- When lightly soiled, wipe with a sponge or soft lint-free cloth dampened with water.
- When heavily soiled, use warm soapy water.

You can remove scratches from a coated molding by wiping briskly with the solvent-type cleaner described earlier. If a ring forms, repeat the procedure over a larger area, wiping toward the center of the ring. If the ring still remains, wipe the whole molding.

Cleaning Leather

Use a soft cloth with lukewarm water and a mild soap or saddle soap.

- For stubborn stains, use a GM Vinyl/Leather Cleaner or equivalent product.
- *Never* use oils, varnishes, solvent-based or abrasive cleaners, furniture polish or shoe polish on leather.
- Soiled leather should be cleaned immediately. If dirt is allowed to work into the finish, it can harm the leather.

Cleaning the Top of the Instrument Panel

Use only mild soap and water to clean the top surfaces of the instrument panel. Sprays containing silicones or waxes may cause annoying reflections in the windshield and even make it difficult to see through the windshield under certain conditions.

Cleaning Soft-Touch Paint Surfaces

Use only mild soap and water to clean the Soft-Touch paint surfaces in your Corvette.

Cleaning Speaker Covers

Vacuum around a speaker cover gently, so that the speaker won't be damaged. Some spots and stains will clean off better with just water and mild soap. If something gets on one of them and you need to use a solvent, follow these steps:

- Gently scrape excess soil from the trim material with a clean, dull knife or scraper. Use very little cleaner, light pressure and clean cloths (preferably cheesecloth). Cleaning should start at the outside of the stain, "feathering" toward the center. Keep changing to a clean section of the cloth.
- When you clean a stain from fabric, immediately dry the area with a blow dryer to help prevent a cleaning ring.

Care of Safety Belts

Keep belts clean and dry.



CAUTION:

Do not bleach or dye safety belts. If you do, it may severely weaken them. In a crash they might not be able to provide adequate protection. Clean safety belts only with mild soap and lukewarm water.

Glass

Glass should be cleaned often. GM Glass Cleaner (GM Part No. 1050427) or a liquid household glass cleaner will remove normal tobacco smoke and dust films.

Don't use abrasive cleaners on glass, because they may cause scratches. Avoid placing decals on the inside rear window, since they may have to be scraped off later. If abrasive cleaners are used on the inside of the rear window, an electric defogger element may be damaged. Any temporary license should not be attached across the defogger grid.

Cleaning the Outside of the Windshield and Wiper Blades

If the windshield is not clear after using the windshield washer, or if the wiper blade chatters when running, wax or other material may be on the blade or windshield.

Clean the outside of the windshield with GM Windshield Cleaner, Bon-Ami Powder[®] (GM Part No. 1050011). The windshield is clean if beads do not form when you rinse it with water.

If you use a glass treatment or conditioner containing ethyl alcohol or ethyl sulfate on your glass, be sure to remove the acrylic roof panel, if so equipped. These products may damage the panel.

Clean the blade by wiping vigorously with a cloth soaked in full-strength windshield washer solvent. Then rinse the blade with water.

Wiper blades should be checked on a regular basis and replaced when worn.

Weatherstrips

Silicone grease on weatherstrips will make them last longer, seal better, and not stick or squeak. Apply silicone grease with a clean cloth at least every six months. During very cold, damp weather more frequent

application may be required. (See “Recommended Fluids and Lubricants” in the Index.)

Cleaning a Removable Roof Panel

Special care is necessary when cleaning, removing and/or storing the roof panel.

- Flush with water to remove dust and dirt, then dry the panel.
- Clean the panel with GM Glass Cleaner. Leave the cleaner on the panel for one minute, then wipe the panel with a soft, lint-free cloth.
- Don't use abrasive cleaning materials.

If water drops are frequently allowed to dry on the roof panel, impurities in the water will adhere to the top. These impurities may destroy the finish. When the panel gets wet, you should dry it off.

NOTICE:

Do not use a glass treatment or conditioner containing ethyl alcohol or ethyl sulfate on the roof panel. These products may damage the panel.

Cleaning the Outside of Your Corvette

The paint finish on your vehicle provides beauty, depth of color, gloss retention and durability.

Washing Your Vehicle

The best way to preserve your vehicle's finish is to keep it clean by washing it often with lukewarm or cold water.

Don't wash your vehicle in the direct rays of the sun. Don't use strong soaps or chemical detergents. Use liquid hand, dish or car washing (mild detergent) soaps. Don't use cleaning agents that are petroleum based, or that contain acid or abrasives. All cleaning agents should be flushed promptly and not allowed to dry on the surface, or they could stain. Dry the finish with a soft, clean chamois or a 100% cotton towel to avoid surface scratches and water spotting.

High pressure car washes may cause water to enter your vehicle.

NOTICE:

Conveyor systems on some automatic car washes may damage a Corvette. They may not have enough clearance for the undercarriage or for the extra wide rear tires on Grand Sport Coupe models.

Check with the manager before using a car wash.

Finish Care

Occasional waxing or mild polishing of your Corvette by hand may be necessary to remove residue from the paint finish. You can get GM-approved cleaning products from your dealer. (See "Appearance Care and Materials" in the Index.)

Your Corvette has a “basecoat/clearcoat” paint finish. The clearcoat gives more depth and gloss to the colored basecoat. Always use waxes and polishes that are non-abrasive and made for a basecoat/clearcoat paint finish.

NOTICE:

Machine compounding or aggressive polishing on a basecoat/clearcoat paint finish may dull the finish or leave swirl marks.

Foreign materials such as calcium chloride and other salts, ice melting agents, road oil and tar, tree sap, bird droppings, chemicals from industrial chimneys, etc. can damage your vehicle’s finish if they remain on painted surfaces. Wash the vehicle as soon as possible. If necessary, use non-abrasive cleaners that are marked safe for painted surfaces to remove foreign matter.

Exterior painted surfaces are subject to aging, weather and chemical fallout that can take their toll over a period of years. You can help to keep the paint finish looking new by keeping your Corvette garaged or covered whenever possible.

Cleaning Your Convertible Top

Your convertible top should be cleaned often. If you use an automatic car wash, use one with water jets and hanging cloths.

When you hand wash the top, do it in partial shade. Use a mild soap, lukewarm water and a soft sponge. A chamois or cloth may leave lint on the top, and a brush can chafe the threads in the top fabric. Don’t use detergents, harsh cleaners, solvents or bleaching agents.

When you clean the top, put one hand under it to support it. Wet the entire vehicle and wash the top evenly to avoid spots or rings. Let the soap remain on the fabric for a few minutes. When the top is really dirty, use a mild foam-type cleaner. Thoroughly rinse the entire vehicle, then let the top dry in direct sunlight.

To protect the convertible top:

- After you wash the vehicle, make sure the top is completely dry before you lower it.
- Don’t get any cleaner on the vehicle’s painted finish; it could leave streaks.
- If you decide to go through an automatic car wash, ask the manager if the equipment could damage your top.

Cleaning and Storage of Your Hardtop

The optional hardtop has the same durable finish as the painted surfaces of your Corvette. You can wash, polish and wax it.

If you store the hardtop for a long time, keep it covered in a dry place. Apply silicone grease to all the weatherstrips.

Aluminum Wheels

Your aluminum wheels have a protective coating similar to the painted surface of your vehicle. Don't use strong soaps, chemicals, chrome polish, abrasive cleaners or abrasive cleaning brushes on them because you could damage this coating. After rinsing thoroughly, a wax may be applied.

NOTICE:

Don't use an automatic car wash that has hard silicon carbide cleaning brushes. These brushes can take the protective coating off your aluminum wheels.

Tires

To clean your tires, use a stiff brush with a tire cleaner.

NOTICE:

When applying a tire dressing always take care to wipe off any overspray or splash from all painted surfaces on the body or wheels of the vehicle. Petroleum-based products may damage the paint finish.

Finish Damage

Any stone chips, fractures or deep scratches in the finish should be repaired right away.

Minor chips and scratches can be repaired with touch-up materials available from your dealer or other service outlets. Larger areas of finish damage can be corrected in your dealer's body and paint shop.

Underbody Maintenance

Chemicals used for ice and snow removal and dust control can collect on the underbody. If these are not removed, accelerated corrosion (rust) can occur on the underbody parts such as fuel lines, frame, floor pan, and exhaust system even though they have corrosion protection.

At least every spring, flush these materials from the underbody with plain water. Clean any areas where mud and other debris can collect. Dirt packed in closed areas of the frame should be loosened before being flushed. Your dealer or an underbody vehicle washing system can do this for you.

Fiberglass Springs

NOTICE:

Don't use corrosive or acidic cleaning agents, engine degreasers, aluminum cleaning agents or other harsh solvents to clean fiberglass springs; they'll damage the springs.

Chemical Paint Spotting

Some weather and atmospheric conditions can create a chemical fallout. Airborne pollutants can fall upon and attack painted surfaces on your vehicle. This damage can take two forms: blotchy, ringlet-shaped discolorations, and small irregular dark spots etched into the paint surface.

Although no defect in the paint job causes this, Corvette will repair, at no charge to the owner, the surfaces of new vehicles damaged by this fallout condition within 12 months or 12,000 miles (20 000 km) of purchase, whichever occurs first.

Appearance Care Materials Chart

| PART NUMBER | SIZE | DESCRIPTION | USAGE |
|---|------------------|---|--|
| 1050004 | 2.75 sq. ft. | Chamois | Shines vehicle without scratching |
| 1050172 | 16 oz. (0.473 L) | Tar and Road Oil Remover | Also removes old waxes and polishes |
| 1050173 | 16 oz. (0.473 L) | Chrome Cleaner and Polish | Removes rust and corrosion |
| 1050174 | 16 oz. (0.473 L) | White Sidewall Tire Cleaner | Removes soil and black marks |
| 1050201 | 16 oz. (0.473 L) | Magic Mirror Cleaner Polish | Exterior cleaner and polish |
| 1050214 | 32 oz. (0.946 L) | Vinyl and Leather Cleaner | Spot and stain removal |
| 1050427 | 23 oz. (0.680 L) | Glass Cleaner | Cleans grease, grime and smoke film |
| 1050429 | 6 lbs. (2.72 kg) | Multi-Purpose Powdered Cleaner | Cleans vinyl, cloth, tires and mats |
| 1051398* | 8 oz. (0.237 L) | Spot Lifter | For cloth |
| 1051515 | 32 oz. (0.946 L) | Optikleen | Windshield washer solvent and antifreeze |
| 1052870 | 16 oz. (0.473 L) | Wash and Wax Concentrate | Exterior wash |
| 1052918** | 8 oz. (0.237 L) | Armor All™ Protector | Protects vinyl, leather and rubber |
| 1052929 | 16 oz. (0.473 L) | Wheel Cleaner | Spray on wheel cleaner |
| 1052930 | 8 oz. (0.237 L) | Capture Dry Spot Remover | Attracts and absorbs soils |
| 12345002** | 16 oz. (0.473 L) | Armor All™ Cleaner | Cleans vinyl, leather and rubber |
| 12345725 | 12 oz. (0.354 L) | Silicone Tire Shine | Shines tires |
| See your General Motors Parts Department for these products. See "Fluids and Lubricants" in the Index. | | * Not recommended for pigskin suede leather. ** Not recommended for use on instrument panel vinyl. | |

Vehicle Identification Number (VIN)

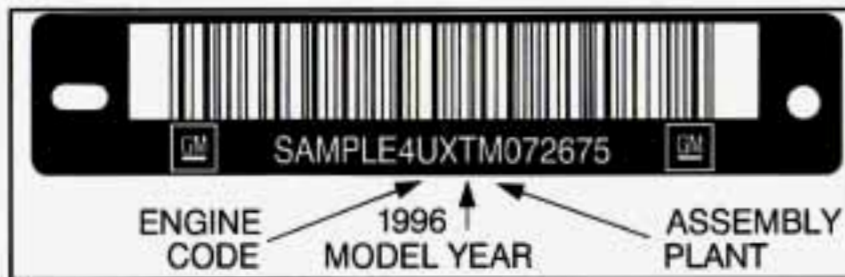

This is the legal identifier for your Corvette. It appears on a plate in the front corner of the instrument panel, on the driver's side. You can see it if you look through the windshield from outside your vehicle. The VIN also appears on the Vehicle Certification and Service Parts labels and the certificates of title and registration.

Engine Identification

The eighth character in your VIN is the engine code. This code will help you identify your engine, specifications, and replacement parts.

Service Parts Identification Label

You'll find this label on the inside of your rear storage compartment. It's very helpful if you ever need to order parts. On this label is:

- your VIN,
- the model designation,
- paint information, and
- a list of all production options and special equipment.

Be sure that this label is not removed from the vehicle.

Electrical System

Add-On Electrical Equipment

NOTICE:

Don't add anything electrical to your Corvette unless you check with your dealer first. Some electrical equipment can damage your vehicle and the damage wouldn't be covered by your warranty. Some add-on electrical equipment can keep other components from working as they should.

Your vehicle has an air bag system. Before attempting to add anything electrical to your Corvette, see "Servicing Your Air Bag-Equipped Corvette" in the Index.

Headlamps

The headlamp wiring is protected by a circuit breaker. An electrical overload will cause the lamps to go on and off, or in some cases to remain off. If this happens, have your headlamp wiring checked right away.

Windshield Wipers

The windshield wiper motor is protected by a fuse and an internal circuit breaker. If the motor overheats due to heavy snow, etc., the wiper will stop until the motor cools. If the overload is caused by some electrical problem and not snow, etc., be sure to get it fixed.

Power Windows and Other Power Options

Circuit breakers protect the power windows and other power accessories. When the current load is too heavy, the circuit breaker opens and closes, protecting the circuit until the problem is fixed or goes away.

Fuses and Circuit Breakers

The wiring circuits in your vehicle are protected from short circuits by a combination of maxi-fuses, mini-fuses and circuit breakers. This greatly reduces the chance of fires caused by electrical problems.

Look at the silver-colored band inside the fuse. If the band is broken or melted, replace the fuse. Be sure you replace a bad fuse with a new one of the identical size and rating.

If you ever have a problem on the road and don't have a spare fuse, you can borrow one that has the same amperage. Just pick some feature of your vehicle that you can get along without -- like the radio or cigarette lighter -- and use its fuse, if it is the correct amperage. Replace it as soon as you can.

Instrument Panel Fuse Block



The interior fuse center is on the right side of your instrument panel. Turn the knob and pull the door to access the fuses.

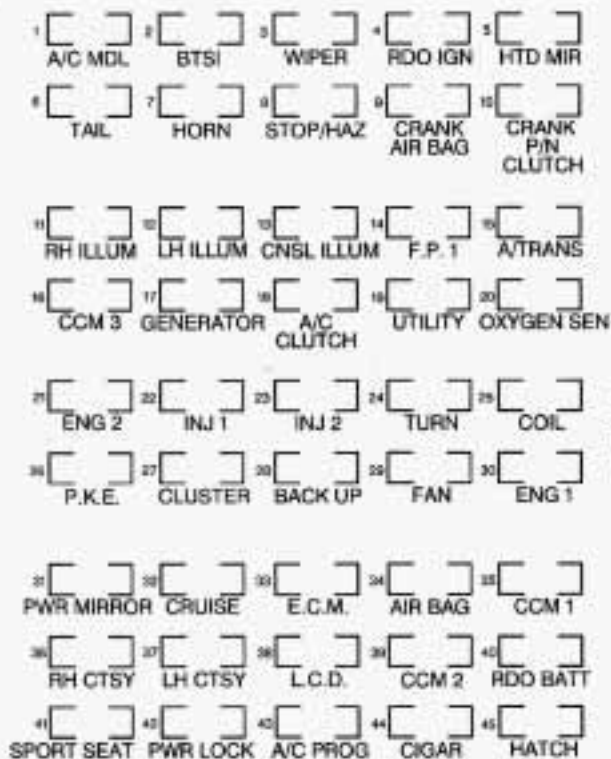

CIRCUIT BREAKERS

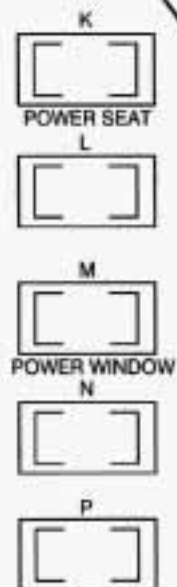

Two maxi - fuse blocks are located under hood near battery.

| Fuse | Usage | Fuse | Usage |
|-------------|--|-------------|---|
| 1 | Heater, A/C Programmer | 13 | Console Illumination |
| 2 | Brake-Transmission Shift Interlock | 14 | Fuel Pump 1 |
| 3 | Windshield Wiper/Washer Switch Assembly | 15 | Automatic Transmission |
| 4 | Radio Receiver (Ignition) | 16 | Central Control Module, Daytime Running Lamps Module |
| 5 | Heated Mirrors, Heater and A/C Control Head, Heater and A/C Programmer | 17 | Generator |
| 6 | Light Switch, Daytime Running Lamps Module | 18 | A/C Compressor Clutch, Heater and A/C Control Head, Heater and A/C Programmer, Rear Defog Relay |
| 7 | Horn Relay | 19 | Accessory Plug |
| 8 | Hazard Flashers, Brake Switch | 20 | Heated Oxygen Sensors |
| 9 | Crank-Air Bag | 21 | Real Time Damping Module, ABS Module, HVAC Solenoid Assembly |
| 10 | Crank-Park/Neutral Switch (Automatic), Clutch Switch (Manual) | 22 | Injectors #1, 4, 6, 7 |
| 11 | RH Illumination | 23 | Injectors #2, 3, 5, 8 |
| 12 | LH Illumination | 24 | Turn Signal Flashers |
| | | 25 | Ignition Coil and Ignition Coil Module |

| Fuse | Usage | Fuse | Usage |
|-------------|--|-------------|--|
| 26 | Passive Keyless Entry Module | 34 | Air Bag System |
| 27 | Instrument Cluster, Driver Information Center, Air Bag System | 35 | Central Control Module |
| 28 | Back-up Lamps Switch, Transmission Position Switch, One to Four Shift Solenoid | 36 | Footwell Courtesy Lamps, Door Courtesy Lamps, Glove Compartment Lamps, Lighted Rearview Mirror |
| 29 | Cooling Fan Relay Coil #1, 2, 3 | 37 | Bose Amplifier Relay, Power Antenna Relay, Cargo Compartment Lamps |
| 30 | Canister Purge Solenoid, EGR Circuit (LT1), Mass Airflow Sensor, One to Four Shift Relay, Brake Switch (Automatic), Air Pump Relay | 38 | Instrument Cluster, Tone Generator, Dome Lamp Relay |
| 31 | Power Mirror Adjuster Control, Lighted Rearview Mirror, Visor Vanity Mirrors | 39 | Central Control Module |
| 32 | Cruise Control Engage Switch, Daytime Running Lamps Module, Low Tire Pressure Warning Module, Cruise Control Cut-off Relay | 40 | Radio Receiver (Battery), Radio Control Head, Passive Keyless Entry Module |
| 33 | Engine Control Module | 41 | Sport Seats |
| | | 42 | Power Door Lock Switches, Driver Information Center, Passive Keyless Entry Module |
| | | 43 | Heater and A/C Programmer |

| Fuse | Usage |
|------|-----------------------------------|
| 44 | Cigarette Lighter, Accessory Plug |
| 45 | Hatch or Deck Lid Release Relay |
| K | Power Seats |
| L | Blank |
| M | Power Windows |
| N | Blank |
| P | Blank |

Engine Compartment Fuse Blocks

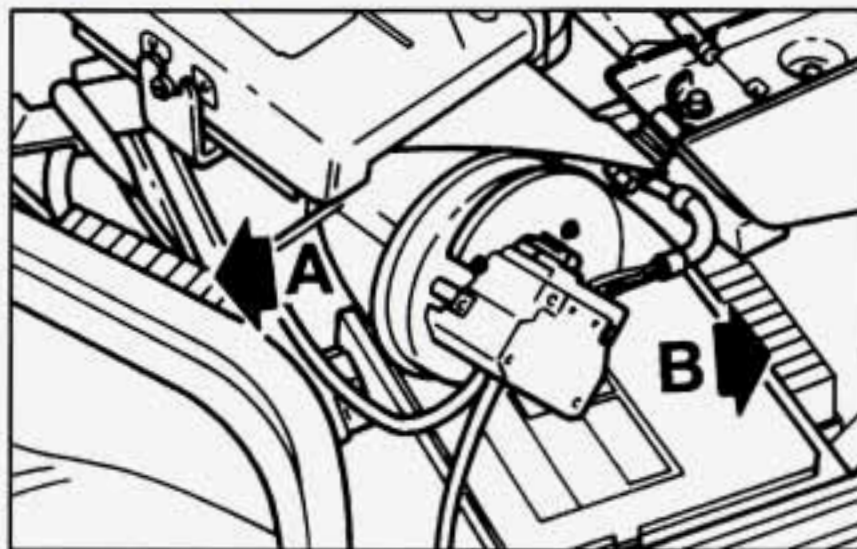

There are two maxi-fuse blocks in the engine compartment. One is part of the forward lamp wiring harness (A), and the other is part of the ECM-engine wiring harness (B).

Forward Lamp Fuse Block

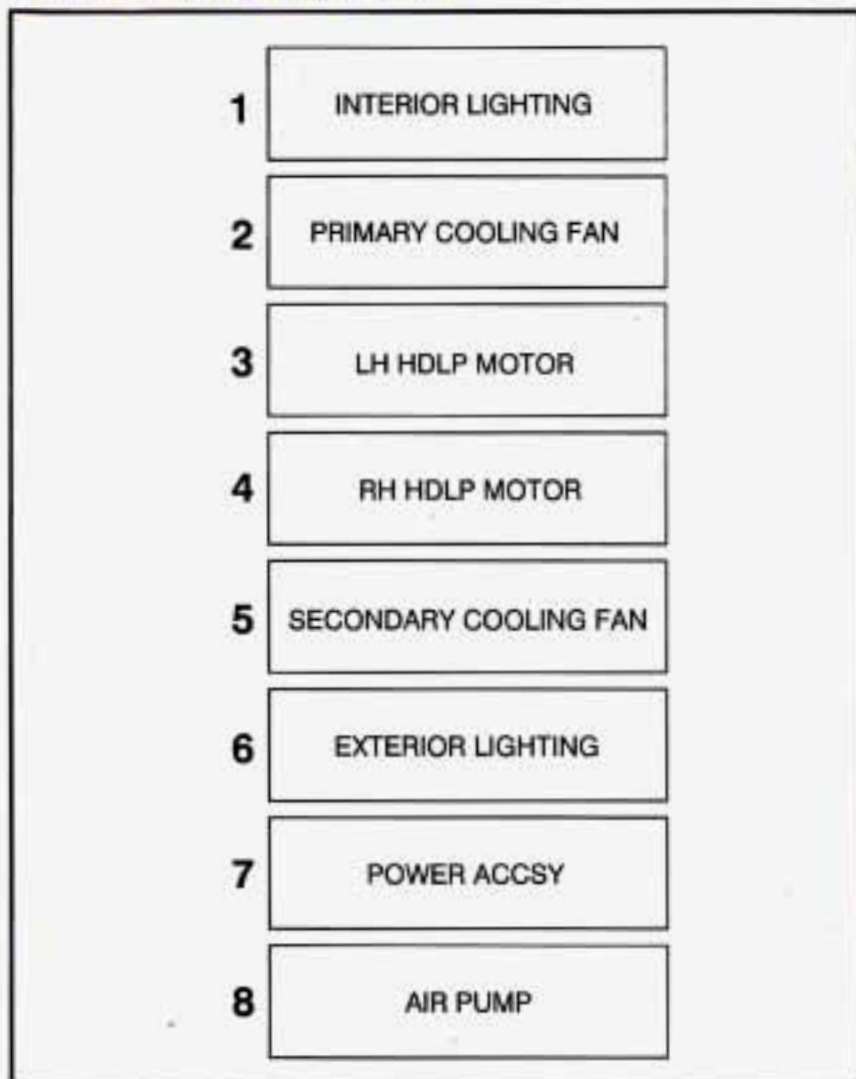

| Fuse | Usage |
|------|--|
| 1 | Interior Lighting |
| 2 | Primary Cooling Fan |
| 3 | LH Headlamp Motor |
| 4 | RH Headlamp Motor |
| 5 | Secondary Cooling Fan |
| 6 | Exterior Lighting |
| 7 | Power Accessory (Power Locks, Hatch, Lighter, Seats) |
| 8 | Air Pump |

ECM Engine Fuse Block

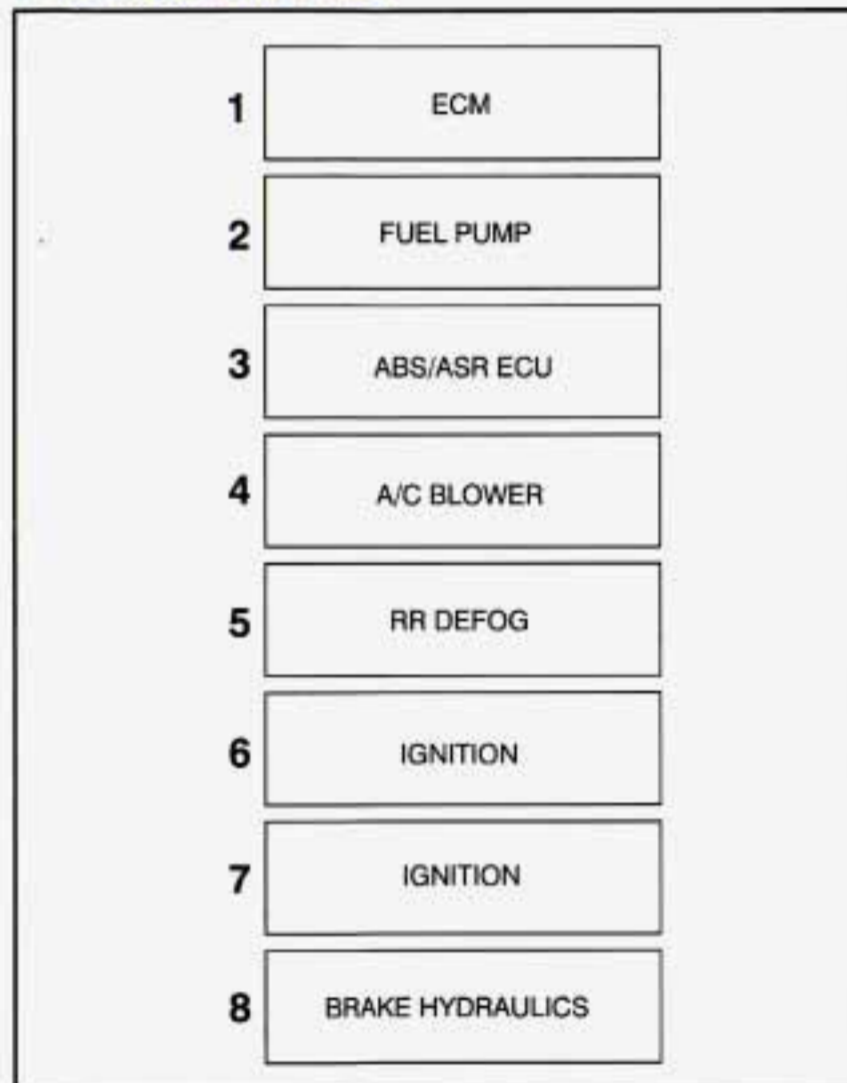

| Fuse | Usage |
|------|---|
| 1 | Engine Control Module |
| 2 | Fuel Pump |
| 3 | Anti-Lock Brakes, Acceleration Slip Regulation System |
| 4 | A/C Blower |
| 5 | Rear Defogger |
| 6 | Ignition |
| 7 | Ignition |
| 8 | Brake Hydraulics |

Underhood Lamps Fuse



Your Corvette has one single fuse underhood for the underhood lamps. The fuse is under the hood on the driver's sidemarker lamp assembly.

Leaving your hood open and your underhood lamps on can drain your battery. If you need to keep the hood open for an extended period of time, remove the underhood lamps fuse.

Ride Control Fuse

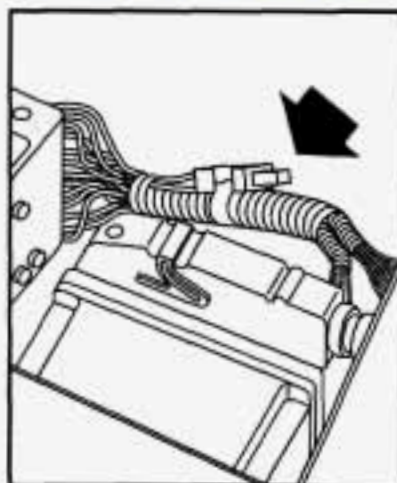

Vehicles equipped with the optional Real Time Damping ride control system are fuse protected with a fuse located in the ABS compartment behind the driver's seat.

To access this fuse, pull back the carpet, remove the screw and lift the cover.

Replacement Bulbs

| | | | |
|---|--------|--|--------|
| Air Conditioning and Heater Control | 37 | Headlamp | HP6054 |
| Automatic Transmission Indicator | 194NA | Instrument Cluster | * |
| Back-up | 1156 | License | 24 |
| Center High-Mounted Stoplamp | 1156 | Mirror Flood | 74 |
| Console | 564 | Mirror Reading | 168 |
| Cornering | 1156 | Radio | * |
| Door Courtesy | 212-2 | Rear Courtesy (Convertible) | 562 |
| Door Flood | 73 | Rear Courtesy (except Convertible) | 906 |
| Driver Information Center | * | Sidemarkers | 24 |
| Floor Courtesy | 562 | Tail/Stop/Turn | 2057 |
| Fog | 896 | Underhood | 212-2 |
| Front Parking/Turn Signal | 2057NA | Visor Vanity Mirror | 74 |

** These bulbs are not owner-serviceable. See your dealer.*

Capacities and Specifications

Engine

| | |
|--|---|
| Type | V8 |
| VIN Engine Code | |
| LT1 | P |
| LT4 | 5 |
| Fuel Delivery | Sequential Multiport Fuel Injection (SFI) |
| Valve Arrangement | Overhead Valve |
| Piston Displacement | 350 CID (5.7L) |
| Bore | 4.00 inches (101.6 mm) |
| Stroke | 3.48 inches (88.39 mm) |
| Compression Ratio | |
| LT1 | 10.5:1 |
| LT4 | 10.67:1 |
| Horsepower | |
| LT1 | 300 |
| LT4 | 330 |
| Firing Order | 1-8-4-3-6-5-7-2 |
| Thermostat Temperature Specification | 180°F (82°C) |

Replacement Parts

| | |
|--|---|
| Air Cleaner Filter | A1097C GM Part No. 25096933 or equivalent |
| Battery | 75B-72 |
| Coolant High Fill Reservoir Cap | RC27 15 psi (105 kPa) GM Part No. 6410782 or equivalent |
| Crankcase Ventilation Valve | CV895C |
| Engine Oil Filter | PF52 GM Part No. 25010908 or equivalent |
| Flat Ratchet Wrench (Convertible Hardtop Only) | GM Part No. 10137741 or equivalent |
| PCV Valve | AC Type CV895C |
| Serpentine Belt | GM Part No. 10230259 or equivalent |
| Spark Plug | 41-943 (0.050 inch Gap) GM Part No. 5614244 or equivalent |
| Thermostat | GM Part No. 10223370 or equivalent |
| Torx [®] Wrench | GM Part No. 10172311 or equivalent |
| Windshield Wiper Blade | |
| Length | 20 inches (508 mm) |
| Type | 0.25 inch (6.35 mm) pin |

Wheel Nuts

| | |
|------------------|---------------------|
| Wheel Nut Torque | 100 lb-ft (140 N·m) |
|------------------|---------------------|

Capacities (Approximate)

The following approximate capacities are given in English and metric conversions.

| | |
|--------------------------------|--|
| Air Conditioning | See the refrigerant information label under the hood. |
| Automatic Transmission | |
| Drain and Refill | 5 quarts (4.7 L)* |
| Overhaul | 10.8 quarts (10.2 L)* |
| Cooling System | |
| LT1 | 14.5 quarts (13.7 L) |
| LT4 | 14.6 quarts (13.8 L) |
| Crankcase | |
| Without Filter Change | 4.0 quarts (3.8 L)* |
| With Filter Change | 4.5 quarts (4.3 L)* |
| Fuel Tank | 20.0 gallons (75.7 L) |
| Manual Transmission (Overhaul) | 2.2 quarts (2.1 L)* |
| Rear Axle | |
| Lubricant | 1.5 quarts (1.42 L) |
| Limited Slip Additive | 4.0 ounces (118 ml) |
| Tire Pressures | See Tire-Loading Information label on rear edge of driver's door |

* Recheck fluid level after filling. See Section 6 or the Index.

Vehicle Dimensions

| | |
|-----------------------------|-------------------------|
| Wheelbase | 96.2 inches (2 444 mm) |
| Tread | |
| Front/Rear | 57.7 inches (1 466 mm) |
| Coupe and Convertible | 59.1 inches (1 500 mm) |
| Grand Sport | 60.6 inches (1 539 mm) |
| Length | 178.5 inches (4 535 mm) |
| Width | |
| Coupe | 70.7 inches (1 796 mm) |
| Convertible | 73.1 inches (1 856 mm) |
| Height | |
| Coupe | 46.3 inches (1 177 mm) |
| Convertible | 47.3 inches (1 202 mm) |

Power Curves -- LT1 Engine

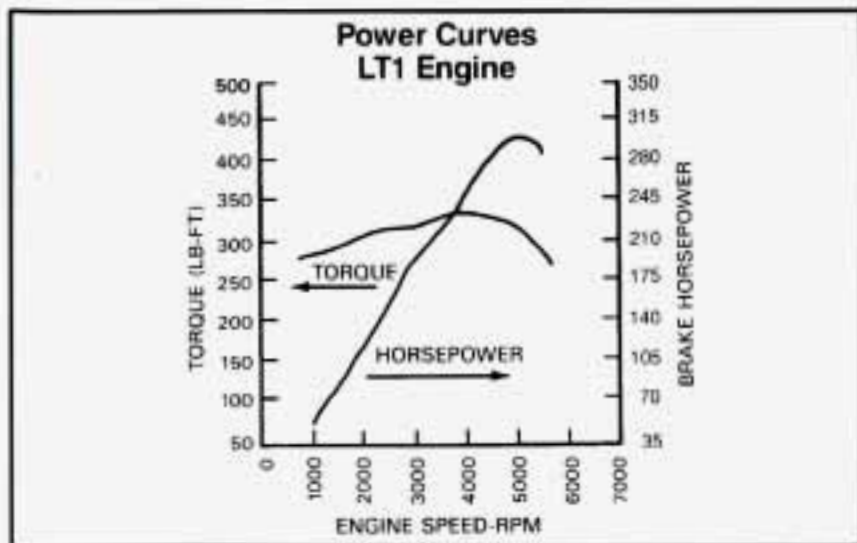

Power Curves -- LT4 Engine

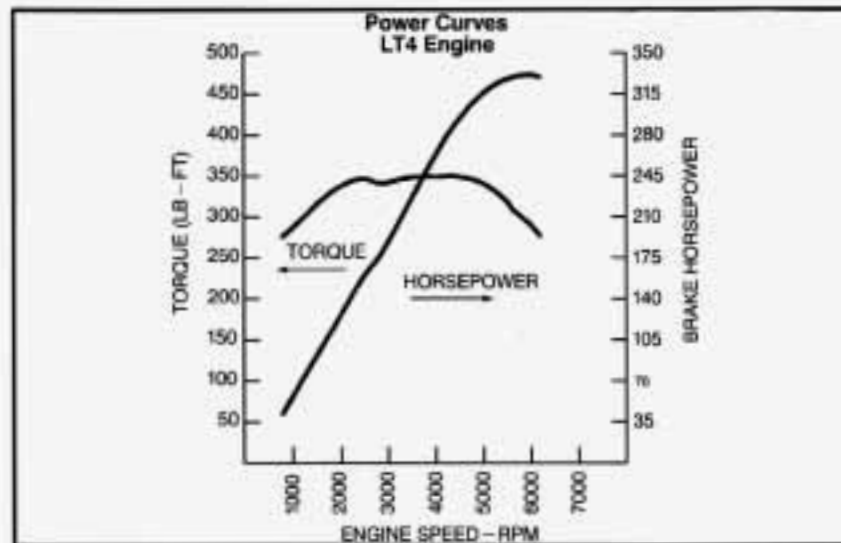

Accessory Belt Routing

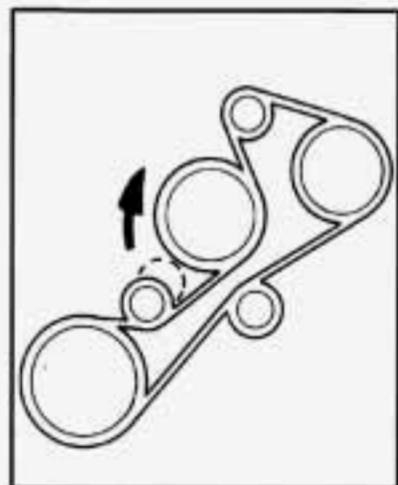

Air Conditioning Refrigerants

Not all air conditioning refrigerants are the same. If the air conditioning system in your vehicle needs refrigerant, be sure the proper refrigerant is used. If you're not sure, ask your Corvette dealer.

NOTES



Section 7 Maintenance Schedule

**IMPORTANT:
KEEP ENGINE OIL
AT THE PROPER
LEVEL AND CHANGE AS
RECOMMENDED**

This section covers the maintenance required for your Corvette. Your vehicle needs these services to retain its safety, dependability and emission control performance.



***Protection
Plan***

Have you purchased the GM Protection Plan? The Plan supplements your new vehicle warranties. See your Warranty and Owner Assistance booklet, or your Corvette dealer for details.

Introduction

Your Vehicle and the Environment

Proper vehicle maintenance not only helps to keep your vehicle in good working condition, but also helps the environment. All recommended maintenance procedures are important. Improper vehicle maintenance can even affect the quality of the air we breathe. Improper fluid levels or the wrong tire inflation can increase the level of emissions from your vehicle. To help protect our environment, and to keep your vehicle in good condition, please maintain your vehicle properly.

How This Section is Organized

The remainder of this section is divided into five parts:

“Part A: Scheduled Maintenance Services” shows what to have done and how often. Some of these services can be complex, so unless you are technically qualified and have the necessary equipment, you should let your dealer’s service department or another qualified service center do these jobs.

CAUTION:

Performing maintenance work on a vehicle can be dangerous. In trying to do some jobs, you can be seriously injured. Do your own maintenance work only if you have the required know-how and the proper tools and equipment for the job. If you have any doubt, have a qualified technician do the work.

If you are skilled enough to do some work on your vehicle, you will probably want to get the service information GM publishes. See “Service and Owner Publications” in the Index.

“Part B: Owner Checks and Services” tells you what should be checked whenever you stop for fuel. It also explains what you can easily do to help keep your vehicle in good condition.

“Part C: Periodic Maintenance Inspections” explains important inspections that your Corvette dealer’s service department or another qualified service center should perform.

“Part D: Recommended Fluids and Lubricants” lists some products GM recommends to help keep your vehicle properly maintained. These products, or their equivalents, should be used whether you do the work yourself or have it done.

“Part E: Maintenance Record” provides a place for you to record the maintenance performed on your vehicle. Whenever any maintenance is performed, be sure to write it down in this part. This will help you determine when your next maintenance should be done. In addition, it is a good idea to keep your maintenance receipts. They may be needed to qualify your vehicle for warranty repairs.

Part A: Scheduled Maintenance Services

Using Your Maintenance Schedule

We at General Motors want to help you keep your vehicle in good working condition. But we don't know exactly how you'll drive it. You may drive very short distances only a few times a week. Or you may drive long distances all the time in very hot, dusty weather. You may use your vehicle in making deliveries. Or you may drive it to work, to do errands or in many other ways.

Because of all the different ways people use their GM vehicles, maintenance needs vary. You may even need more frequent checks and replacements than you'll find in the schedules in this section. So please read this section and note how you drive. If you have any questions on how to keep your vehicle in good condition, see your Corvette dealer.

This part tells you the maintenance services you should have done and when you should schedule them. If you go to your dealer for your service needs, you'll know that GM-trained and supported service people will perform the work using genuine GM parts.

The proper fluids and lubricants to use are listed in Part D. Make sure whoever services your vehicle uses these. All parts should be replaced and all necessary repairs done before you or anyone else drives the vehicle.

These schedules are for vehicles that:

- carry passengers and cargo within recommended limits. You will find these limits on your vehicle's Tire-Loading Information label. See "Loading Your Vehicle" in the Index.
- are driven on reasonable road surfaces within legal driving limits.
- use the recommended fuel. See "Fuel" in the Index.

Selecting the Right Schedule

First you'll need to decide which of the two schedules is right for your vehicle. Here's how to decide which schedule to follow:

Maintenance Schedule

Short Trip/City Definition

Follow the Short Trip/City Maintenance Schedule if any one of these conditions is true for your vehicle:

- Most trips are less than 5 to 10 miles (8 to 16 km). This is particularly important when outside temperatures are below freezing.
- Most trips include extensive idling (such as frequent driving in stop-and-go traffic).
- Most trips are through dusty areas.
- If the vehicle is used for delivery service, police, taxi or other commercial application.

One of the reasons you should follow this schedule if you operate your vehicle under any of these conditions is that these conditions cause engine oil to break down sooner.

Short Trip/City Intervals

Every 3,000 Miles (5 000 km): Engine Oil and Filter Change (or 3 months, whichever occurs first).

Every 6,000 Miles (10 000 km): Chassis Lubrication (or 6 months, whichever occurs first).

Every 15,000 Miles (25 000 km): Air Cleaner Filter Inspection, if driving in dusty conditions. Automatic Transmission Service (severe conditions only).

Every 30,000 Miles (50 000 km): Air Cleaner Filter Replacement. Fuel Tank, Cap and Lines Inspection.

Every 60,000 Miles (100 000 km): Engine Accessory Drive Belt Inspection.

Every 100,000 Miles (166 000 km): Cooling System Service (or every 60 months, whichever occurs first). Spark Plug Wire Inspection. Spark Plug Replacement. Automatic Transmission Service (normal conditions).

These intervals only summarize maintenance services. Be sure to follow the complete maintenance schedule on the following pages.

Maintenance Schedule

Long Trip/Highway Definition

Follow this maintenance schedule *only* if none of the conditions from the Short Trip/City Maintenance Schedule is true.

Driving a vehicle with a fully warmed engine under highway conditions causes engine oil to break down slower.

Long Trip/Highway Intervals

Every 7,500 Miles (12 500 km): Engine Oil and Filter Change (or every 12 months, whichever occurs first). Chassis Lubrication (or every 12 months, whichever occurs first).

Every 15,000 Miles (25 000 km): Automatic Transmission Service (severe conditions only).

Every 30,000 Miles (50 000 km): Air Cleaner Filter Replacement. Fuel Tank, Cap and Lines Inspection.

Every 60,000 Miles (100 000 km): Engine Accessory Drive Belt Inspection.

Every 100,000 Miles (166 000 km): Cooling System Service (or every 60 months, whichever occurs first). Spark Plug Wire Inspection. Spark Plug Replacement. Automatic Transmission Service (normal conditions).

These intervals only summarize maintenance services. Be sure to follow the complete maintenance schedule on the following pages.

Short Trip/City Maintenance Schedule

The services shown in this schedule up to 100,000 miles (166 000 km) should be performed after 100,000 miles (166 000 km) at the same intervals.

Footnotes

† The U.S. Environmental Protection Agency or the California Air Resources Board has determined that the failure to perform this maintenance item will not nullify the emission warranty or limit recall liability prior to the completion of the vehicle's useful life. We, however, urge that all recommended maintenance services be performed at the indicated intervals and the maintenance be recorded.

* Your vehicle has an Engine Oil Life Monitor. This monitor will show you when to change the oil -- usually between 3,000 miles (5 000 km) and 7,500 miles (12 500 km) since your last oil change. Under severe conditions the indicator may come on before 3,000 miles (5 000 km). Never drive your vehicle more than 7,500 miles (12 500 km) or 12 months whichever occurs first, without an oil change.

The system won't detect dust in the oil. So if you drive in a dusty area be sure to change your oil every 3,000 miles (5 000 km) or sooner if the CHANGE OIL light comes on. Remember to reset the Oil Life Monitor when the oil has been changed. For more information, see "Engine Oil Life Monitor" in the Index.

Short Trip/City Maintenance Schedule

3,000 Miles (5 000 km)

- Change engine oil and filter (or every 3 months, whichever occurs first).

*An Emission Control Service. **

6,000 Miles (10 000 km)

- Change engine oil and filter (or every 3 months, whichever occurs first).
*An Emission Control Service. **
- Lubricate the suspension, steering and transmission shift linkage, parking brake cable guides, underbody contact points and linkage (or every 6 months, whichever occurs first).

| DATE | ACTUAL MILEAGE | SERVICED BY: |
|------|----------------|--------------|
| | | |

| DATE | ACTUAL MILEAGE | SERVICED BY: |
|------|----------------|--------------|
| | | |

Short Trip/City Maintenance Schedule

9,000 Miles (15 000 km)

- Change engine oil and filter (or every 3 months, whichever occurs first).

*An Emission Control Service. **

| DATE | ACTUAL MILEAGE | SERVICED BY: |
|------|----------------|--------------|
| | | |

12,000 Miles (20 000 km)

- Change engine oil and filter (or every 3 months, whichever occurs first).
*An Emission Control Service. **
- Lubricate the suspension, steering and parking brake cable guides, underbody contact points and linkage (or every 6 months, whichever occurs first).

| DATE | ACTUAL MILEAGE | SERVICED BY: |
|------|----------------|--------------|
| | | |

Short Trip/City Maintenance Schedule

15,000 Miles (25 000 km)

- Change engine oil and filter (or every 3 months, whichever occurs first).
*An Emission Control Service. **
- Inspect air cleaner filter if you are driving in dusty conditions. Replace filter if necessary. *An Emission Control Service. †*
- Change automatic transmission fluid and filter if the vehicle is mainly driven under one or more of these conditions:
 - In heavy city traffic where the outside temperature regularly reaches 90°F (32°C) or higher.

- In hilly or mountainous terrain.
- Uses such as found in taxi, police or delivery service.

If you do not use your vehicle under any of these conditions, change the fluid and filter at 100,000 miles (166 000 km).

Manual transmission fluid doesn't require change.

| DATE | ACTUAL MILEAGE | SERVICED BY: |
|------|----------------|--------------|
| | | |

Short Trip/City Maintenance Schedule

18,000 Miles (30 000 km)

- Change engine oil and filter (or every 3 months, whichever occurs first).
*An Emission Control Service. **
- Lubricate the suspension, steering and parking brake cable guides, underbody contact points and linkage (or every 6 months, whichever occurs first).

| DATE | ACTUAL MILEAGE | SERVICED BY: |
|------|----------------|--------------|
| | | |

21,000 Miles (35 000 km)

- Change engine oil and filter (or every 3 months, whichever occurs first).
*An Emission Control Service. **

| DATE | ACTUAL MILEAGE | SERVICED BY: |
|------|----------------|--------------|
| | | |

Short Trip/City Maintenance Schedule

24,000 Miles (40 000 km)

- Change engine oil and filter (or every 3 months, whichever occurs first).
*An Emission Control Service. **
- Lubricate the suspension, steering and parking brake cable guides, underbody contact points and linkage (or every 6 months, whichever occurs first).

| DATE | ACTUAL MILEAGE | SERVICED BY: |
|------|----------------|--------------|
| | | |

27,000 Miles (45 000 km)

- Change engine oil and filter (or every 3 months, whichever occurs first).
*An Emission Control Service. **

| DATE | ACTUAL MILEAGE | SERVICED BY: |
|------|----------------|--------------|
| | | |

Short Trip/City Maintenance Schedule

30,000 Miles (50 000 km)

- Change engine oil and filter (or every 3 months, whichever occurs first).
*An Emission Control Service. **
- Lubricate the suspension, steering and parking brake cable guides, underbody contact points and linkage (or every 6 months, whichever occurs first).
- Replace air cleaner filter.
An Emission Control Service.
- Inspect fuel tank, cap and lines for damage or leaks. Inspect fuel cap gasket for any damage. Replace parts as needed.
An Emission Control Service. †
- Change automatic transmission fluid and filter if the vehicle is mainly driven under one or more of these conditions:

- In heavy city traffic where the outside temperature regularly reaches 90°F (32°C) or higher.
- In hilly or mountainous terrain.
- Uses such as found in taxi, police or delivery service.

If you do not use your vehicle under any of these conditions, change the fluid and filter at 100,000 miles (166 000 km).

Manual transmission fluid doesn't require change.

| DATE | ACTUAL MILEAGE | SERVICED BY: |
|------|----------------|--------------|
| | | |

Short Trip/City Maintenance Schedule

33,000 Miles (55 000 km)

- Change engine oil and filter (or every 3 months, whichever occurs first).

*An Emission Control Service. **

36,000 Miles (60 000 km)

- Change engine oil and filter (or every 3 months, whichever occurs first).
*An Emission Control Service. **
- Lubricate the suspension, steering and parking brake cable guides, underbody contact points and linkage (or every 6 months, whichever occurs first).

| DATE | ACTUAL MILEAGE | SERVICED BY: |
|------|----------------|--------------|
| | | |

| DATE | ACTUAL MILEAGE | SERVICED BY: |
|------|----------------|--------------|
| | | |

Short Trip/City Maintenance Schedule

39,000 Miles (65 000 km)

- Change engine oil and filter (or every 3 months, whichever occurs first).
*An Emission Control Service. **

| DATE | ACTUAL MILEAGE | SERVICED BY: |
|------|----------------|--------------|
| | | |

42,000 Miles (70 000 km)

- Change engine oil and filter (or every 3 months, whichever occurs first).
*An Emission Control Service. **
- Lubricate the suspension, steering and parking brake cable guides, underbody contact points and linkage (or every 6 months, whichever occurs first).

| DATE | ACTUAL MILEAGE | SERVICED BY: |
|------|----------------|--------------|
| | | |

Short Trip/City Maintenance Schedule

45,000 Miles (75 000 km)

- Change engine oil and filter (or every 3 months, whichever occurs first).
*An Emission Control Service. **
- Change automatic transmission fluid and filter if the vehicle is mainly driven under one or more of these conditions:
 - In heavy city traffic where the outside temperature regularly reaches 90°F (32°C) or higher.
 - In hilly or mountainous terrain.
 - Uses such as found in taxi, police or delivery service.

If you do not use your vehicle under any of these conditions, change the fluid and filter at 100,000 miles (166 000 km).

Manual transmission fluid doesn't require change.

- Inspect air cleaner filter if you are driving in dusty conditions. Replace filter if necessary. *An Emission Control Service. †*

| DATE | ACTUAL MILEAGE | SERVICED BY: |
|------|----------------|--------------|
| | | |

Short Trip/City Maintenance Schedule

48,000 Miles (80 000 km)

- Change engine oil and filter (or every 3 months, whichever occurs first).
*An Emission Control Service. **
- Lubricate the suspension, steering and parking brake cable guides, underbody contact points and linkage (or every 6 months, whichever occurs first).

| DATE | ACTUAL MILEAGE | SERVICED BY: |
|------|----------------|--------------|
| | | |

51,000 Miles (85 000 km)

- Change engine oil and filter (or every 3 months, whichever occurs first).
*An Emission Control Service. **

| DATE | ACTUAL MILEAGE | SERVICED BY: |
|------|----------------|--------------|
| | | |

Short Trip/City Maintenance Schedule

54,000 Miles (90 000 km)

- Change engine oil and filter (or every 3 months, whichever occurs first).
*An Emission Control Service. **
- Lubricate the suspension, steering and parking brake cable guides, underbody contact points and linkage (or every 6 months, whichever occurs first).

| DATE | ACTUAL MILEAGE | SERVICED BY: |
|------|----------------|--------------|
| | | |

57,000 Miles (95 000 km)

- Change engine oil and filter (or every 3 months, whichever occurs first).
*An Emission Control Service. **

| DATE | ACTUAL MILEAGE | SERVICED BY: |
|------|----------------|--------------|
| | | |

Short Trip/City Maintenance Schedule

60,000 Miles (100 000 km)

- Change engine oil and filter (or every 3 months, whichever occurs first).
*An Emission Control Service. **
- Lubricate the suspension, steering and parking brake cable guides, underbody contact points and linkage (or every 6 months, whichever occurs first).
- Change automatic transmission fluid and filter if the vehicle is mainly driven under one or more of these conditions:
 - In heavy city traffic where the outside temperature regularly reaches 90°F (32°C) or higher.
 - In hilly or mountainous terrain.
 - Uses such as found in taxi, police or delivery service.

If you do not use your vehicle under any of these conditions, change the fluid and filter at 100,000 miles (166 000 km).

Manual transmission fluid doesn't require change.

- Inspect engine accessory drive belt.
An Emission Control Service.
- Replace air cleaner filter.
An Emission Control Service.
- Inspect fuel tank, cap and lines for damage or leaks. Inspect fuel cap gasket for any damage. Replace parts as needed.
An Emission Control Service. †

| DATE | ACTUAL MILEAGE | SERVICED BY: |
|------|----------------|--------------|
| | | |

Short Trip/City Maintenance Schedule

63,000 Miles (105 000 km)

- Change engine oil and filter (or every 3 months, whichever occurs first).
*An Emission Control Service. **

| DATE | ACTUAL MILEAGE | SERVICED BY: |
|------|----------------|--------------|
| | | |

66,000 Miles (110 000 km)

- Change engine oil and filter (or every 3 months, whichever occurs first).
*An Emission Control Service. **
- Lubricate the suspension, steering and parking brake cable guides, underbody contact points and linkage (or every 6 months, whichever occurs first).

| DATE | ACTUAL MILEAGE | SERVICED BY: |
|------|----------------|--------------|
| | | |

Short Trip/City Maintenance Schedule

69,000 Miles (115 000 km)

- Change engine oil and filter (or every 3 months, whichever occurs first).

*An Emission Control Service. **

| DATE | ACTUAL MILEAGE | SERVICED BY: |
|------|----------------|--------------|
| | | |

72,000 Miles (120 000 km)

- Change engine oil and filter (or every 3 months, whichever occurs first).
*An Emission Control Service. **
- Lubricate the suspension, steering and parking brake cable guides, underbody contact points and linkage (or every 6 months, whichever occurs first).

| DATE | ACTUAL MILEAGE | SERVICED BY: |
|------|----------------|--------------|
| | | |

Short Trip/City Maintenance Schedule

75,000 Miles (125 000 km)

- Change engine oil and filter (or every 3 months, whichever occurs first).
*An Emission Control Service. **
- Change automatic transmission fluid and filter if the vehicle is mainly driven under one or more of these conditions:
 - In heavy city traffic where the outside temperature regularly reaches 90°F (32°C) or higher.
 - In hilly or mountainous terrain.
 - Uses such as found in taxi, police or delivery service.

If you do not use your vehicle under any of these conditions, change the fluid and filter at 100,000 miles (166 000 km).

Manual transmission fluid doesn't require change.

- Inspect air cleaner filter if you are driving in dusty conditions. Replace filter if necessary. *An Emission Control Service. †*

| DATE | ACTUAL MILEAGE | SERVICED BY: |
|------|----------------|--------------|
| | | |

Short Trip/City Maintenance Schedule

78,000 Miles (130 000 km)

- Change engine oil and filter (or every 3 months, whichever occurs first).
*An Emission Control Service. **
- Lubricate the suspension, steering and parking brake cable guides, underbody contact points and linkage (or every 6 months, whichever occurs first).

| DATE | ACTUAL MILEAGE | SERVICED BY: |
|------|----------------|--------------|
| | | |

81,000 Miles (135 000 km)

- Change engine oil and filter (or every 3 months, whichever occurs first).
*An Emission Control Service. **

| DATE | ACTUAL MILEAGE | SERVICED BY: |
|------|----------------|--------------|
| | | |

Short Trip/City Maintenance Schedule

84,000 Miles (140 000 km)

- Change engine oil and filter (or every 3 months, whichever occurs first).
*An Emission Control Service. **
- Lubricate the suspension, steering and parking brake cable guides, underbody contact points and linkage (or every 6 months, whichever occurs first).

| DATE | ACTUAL MILEAGE | SERVICED BY: |
|------|----------------|--------------|
| | | |

87,000 Miles (145 000 km)

- Change engine oil and filter (or every 3 months, whichever occurs first).
*An Emission Control Service. **

| DATE | ACTUAL MILEAGE | SERVICED BY: |
|------|----------------|--------------|
| | | |

Short Trip/City Maintenance Schedule

90,000 Miles (150 000 km)

- Change engine oil and filter (or every 3 months, whichever occurs first).
*An Emission Control Service. **
- Lubricate the suspension, steering and parking brake cable guides, underbody contact points and linkage (or every 6 months, whichever occurs first).
- Change automatic transmission fluid and filter if the vehicle is mainly driven under one or more of these conditions:
 - In heavy city traffic where the outside temperature regularly reaches 90°F (32°C) or higher.
 - In hilly or mountainous terrain.
 - Uses such as found in taxi, police or delivery service.

If you do not use your vehicle under any of these conditions, change the fluid and filter at 100,000 miles (166 000 km).

Manual transmission fluid doesn't require change.

- Replace air cleaner filter.
An Emission Control Service.
- Inspect fuel tank, cap and lines for damage or leaks. Inspect fuel cap gasket for any damage. Replace parts as needed.
An Emission Control Service. †

| DATE | ACTUAL MILEAGE | SERVICED BY: |
|------|----------------|--------------|
| | | |

Short Trip/City Maintenance Schedule

93,000 Miles (155 000 km)

- Change engine oil and filter (or every 3 months, whichever occurs first).
*An Emission Control Service. **

| DATE | ACTUAL MILEAGE | SERVICED BY: |
|------|----------------|--------------|
| | | |

96,000 Miles (160 000 km)

- Change engine oil and filter (or every 3 months, whichever occurs first).
*An Emission Control Service. **
- Lubricate the suspension, steering and parking brake cable guides, underbody contact points and linkage (or every 6 months, whichever occurs first).

| DATE | ACTUAL MILEAGE | SERVICED BY: |
|------|----------------|--------------|
| | | |

Short Trip/City Maintenance Schedule

99,000 Miles (165 000 km)

- Change engine oil and filter (or every 3 months, whichever occurs first).

*An Emission Control Service. **

100,000 Miles (166 000 km)

- Drain, flush and refill cooling system (or every 60 months since last service, whichever occurs first). See "Engine Coolant" in the Index for what to use. Inspect hoses. Clean radiator, condenser, pressure cap and neck. Pressure test cooling system and pressure cap.

An Emission Control Service. †

| DATE | ACTUAL MILEAGE | SERVICED BY: |
|------|----------------|--------------|
| | | |

Short Trip/City Maintenance Schedule

- Inspect spark plug wires.
An Emission Control Service.
- Replace spark plugs.
An Emission Control Service.

- If you haven't used your vehicle under severe service conditions listed previously and, therefore, haven't changed your automatic transmission fluid, change both the fluid and filter.

| DATE | ACTUAL MILEAGE | SERVICED BY: |
|------|----------------|--------------|
| | | |

Long Trip/Highway Maintenance Schedule

The services shown in this schedule up to 100,000 miles (166 000 km) should be performed after 100,000 miles (166 000 km) at the same intervals.

Footnotes

† The U.S. Environmental Protection Agency or the California Air Resources Board has determined that the failure to perform this maintenance item will not nullify the emission warranty or limit recall liability prior to the completion of the vehicle's useful life. We, however, urge that all recommended maintenance services be performed at the indicated intervals and the maintenance be recorded.

* Your vehicle has an Engine Oil Life Monitor. This monitor will show you when to change the oil -- usually between 3,000 miles (5 000 km) and 7,500 miles (12 500 km) since your last oil change. Under severe conditions, the indicator may come on before 3,000 miles (5 000 km). Never drive your vehicle more than 7,500 miles (12 500 km) or 12 months whichever occurs first, without an oil change.

The system won't detect dust in the oil. So if you drive in a dusty area, be sure to change your oil every 3,000 miles (5 000 km) or sooner if the CHANGE OIL light comes on. Remember to reset the Oil Life Monitor when the oil has been changed. For more information, see "Engine Oil Life Monitor" in the Index.

Long Trip/Highway Maintenance Schedule

7,500 Miles (12 500 km)

- Change engine oil and filter (or every 12 months, whichever occurs first).
*An Emission Control Service. **
- Lubricate the suspension, steering and parking brake cable guides, underbody contact points and linkage (or every 12 months, whichever occurs first).

15,000 Miles (25 000 km)

- Change engine oil and filter (or every 12 months, whichever occurs first).
*An Emission Control Service. **
- Lubricate the suspension, steering and parking brake cable guides, underbody contact points and linkage (or every 12 months, whichever occurs first).
- Change automatic transmission fluid and filter if the vehicle is mainly driven under one or more of these conditions:
 - In heavy city traffic where the outside temperature regularly reaches 90°F (32°C) or higher.

| DATE | ACTUAL MILEAGE | SERVICED BY: |
|------|----------------|--------------|
| | | |

(Continued)

Long Trip/Highway Maintenance Schedule

15,000 Miles (25 000 km) (Continued)

- In hilly or mountainous terrain.
- Uses such as found in taxi, police or delivery service.

If you do not use your vehicle under any of these conditions, change the fluid and filter at 100,000 miles (166 000 km).

Manual transmission fluid doesn't require change.

| DATE | ACTUAL MILEAGE | SERVICED BY: |
|------|----------------|--------------|
| | | |

22,500 Miles (37 500 km)

- Change engine oil and filter (or every 12 months, whichever occurs first).
*An Emission Control Service. **
- Lubricate the suspension, steering and parking brake cable guides, underbody contact points and linkage (or every 12 months, whichever occurs first).

| DATE | ACTUAL MILEAGE | SERVICED BY: |
|------|----------------|--------------|
| | | |

Long Trip/Highway Maintenance Schedule

30,000 Miles (50 000 km)

- Change engine oil and filter (or every 12 months, whichever occurs first).
*An Emission Control Service. **
- Lubricate the suspension, steering and parking brake cable guides, underbody contact points and linkage (or every 12 months, whichever occurs first).
- Change automatic transmission fluid and filter if the vehicle is mainly driven under one or more of these conditions:
 - In heavy city traffic where the outside temperature regularly reaches 90°F (32°C) or higher.
 - In hilly or mountainous terrain.
 - Uses such as found in taxi, police or delivery service.

If you do not use your vehicle under any of these conditions, change the fluid and filter at 100,000 miles (166 000 km).

Manual transmission fluid doesn't require change.

- Replace air cleaner filter.
An Emission Control Service.
- Inspect fuel tank, cap and lines for damage or leaks. Inspect fuel cap gasket for any damage. Replace parts as needed.
An Emission Control Service. †

| DATE | ACTUAL MILEAGE | SERVICED BY: |
|------|----------------|--------------|
| | | |

Long Trip/Highway Maintenance Schedule

37,500 Miles (62 500 km)

- Change engine oil and filter (or every 12 months, whichever occurs first).
*An Emission Control Service. **
- Lubricate the suspension, steering and parking brake cable guides, underbody contact points and linkage (or every 12 months, whichever occurs first).

45,000 Miles (75 000 km)

- Change engine oil and filter (or every 12 months, whichever occurs first).
*An Emission Control Service. **
- Lubricate the suspension, steering and parking brake cable guides, underbody contact points and linkage (or every 12 months, whichever occurs first).
- Change automatic transmission fluid and filter if the vehicle is mainly driven under one or more of these conditions:
 - In heavy city traffic where the outside temperature regularly reaches 90°F (32°C) or higher.

| DATE | ACTUAL MILEAGE | SERVICED BY: |
|------|----------------|--------------|
| | | |

Long Trip/Highway Maintenance Schedule

- In hilly or mountainous terrain.
- Uses such as found in taxi, police or delivery service.

If you do not use your vehicle under any of these conditions, change the fluid and filter at 100,000 miles (166 000 km).

Manual transmission fluid doesn't require change.

52,500 Miles (87 500 km)

- Change engine oil and filter (or every 12 months, whichever occurs first).
*An Emission Control Service. **
- Lubricate the suspension, steering and parking brake cable guides, underbody contact points and linkage (or every 12 months, whichever occurs first).

| DATE | ACTUAL MILEAGE | SERVICED BY: |
|------|----------------|--------------|
| | | |

| DATE | ACTUAL MILEAGE | SERVICED BY: |
|------|----------------|--------------|
| | | |

Long Trip/Highway Maintenance Schedule

60,000 Miles (100 000 km)

- Change engine oil and filter (or every 12 months, whichever occurs first).
*An Emission Control Service. **
- Lubricate the suspension, steering and parking brake cable guides, underbody contact points and linkage (or every 12 months, whichever occurs first).
- Change automatic transmission fluid and filter if the vehicle is mainly driven under one or more of these conditions:
 - In heavy city traffic where the outside temperature regularly reaches 90°F (32°C) or higher.
 - In hilly or mountainous terrain.
 - Uses such as found in taxi, police or delivery service.

If you do not use your vehicle under any of these conditions, change the fluid and filter at 100,000 miles (166 000 km).

Manual transmission fluid doesn't require change.

- Inspect engine accessory drive belt.
An Emission Control Service.
- Replace air cleaner filter.
An Emission Control Service.
- Inspect fuel tank, cap and lines for damage or leaks. Inspect fuel cap gasket for any damage. Replace parts as needed.
An Emission Control Service. †

| DATE | ACTUAL MILEAGE | SERVICED BY: |
|------|----------------|--------------|
| | | |

Long Trip/Highway Maintenance Schedule

67,500 Miles (112 500 km)

- Change engine oil and filter (or every 12 months, whichever occurs first).
*An Emission Control Service. **
- Lubricate the suspension, steering and parking brake cable guides, underbody contact points and linkage (or every 12 months, whichever occurs first).

75,000 Miles (125 000 km)

- Change engine oil and filter (or every 12 months, whichever occurs first).
*An Emission Control Service. **
- Lubricate the suspension, steering and parking brake cable guides, underbody contact points and linkage (or every 12 months, whichever occurs first).
- Change automatic transmission fluid and filter if the vehicle is mainly driven under one or more of these conditions:
 - In heavy city traffic where the outside temperature regularly reaches 90°F (32°C) or higher.

| DATE | ACTUAL MILEAGE | SERVICED BY: |
|------|----------------|--------------|
| | | |

(Continued)

Long Trip/Highway Maintenance Schedule

75,000 Miles (125 000 km) (Continued)

- In hilly or mountainous terrain.
- Uses such as found in taxi, police or delivery service.

If you do not use your vehicle under any of these conditions, change the fluid and filter at 100,000 miles (166 000 km).

Manual transmission fluid doesn't require change.

| DATE | ACTUAL MILEAGE | SERVICED BY: |
|------|----------------|--------------|
| | | |

82,500 Miles (137 500 km)

- Change engine oil and filter (or every 12 months, whichever occurs first).
*An Emission Control Service. **
- Lubricate the suspension, steering and parking brake cable guides, underbody contact points and linkage (or every 12 months, whichever occurs first).

| DATE | ACTUAL MILEAGE | SERVICED BY: |
|------|----------------|--------------|
| | | |

Long Trip/Highway Maintenance Schedule

90,000 Miles (150 000 km)

- Change engine oil and filter (or every 12 months, whichever occurs first).
*An Emission Control Service. **
- Lubricate the suspension, steering and parking brake cable guides, underbody contact points and linkage (or every 12 months, whichever occurs first).
- Change automatic transmission fluid and filter if the vehicle is mainly driven under one or more of these conditions:
 - In heavy city traffic where the outside temperature regularly reaches 90°F (32°C) or higher.
 - In hilly or mountainous terrain.
 - Uses such as found in taxi, police or delivery service.

If you do not use your vehicle under any of these conditions, change the fluid and filter at 100,000 miles (166 000 km).

Manual transmission fluid doesn't require change.

- Replace air cleaner filter.
An Emission Control Service.
- Inspect fuel tank, cap and lines for damage or leaks. Inspect fuel cap gasket for any damage. Replace parts as needed.
An Emission Control Service. †

| DATE | ACTUAL MILEAGE | SERVICED BY: |
|------|----------------|--------------|
| | | |

Long Trip/Highway Maintenance Schedule

97,500 Miles (162 500 km)

- Change engine oil and filter (or every 12 months, whichever occurs first).
*An Emission Control Service. **
- Lubricate the suspension, steering and parking brake cable guides, underbody contact points and linkage (or every 12 months, whichever occurs first).

100,000 Miles (166 000 km)

- Drain, flush and refill cooling system (or every 60 months since last service, whichever occurs first). See "Engine Coolant" in the Index for what to use. Inspect hoses. Clean radiator, condenser, pressure cap and neck. Pressure test the cooling system and pressure cap.
An Emission Control Service. †

| DATE | ACTUAL MILEAGE | SERVICED BY: |
|------|----------------|--------------|
| | | |

Long Trip/Highway Maintenance Schedule

- Inspect spark plug wires.
An Emission Control Service.
- Replace spark plugs.
An Emission Control Service.

- If you haven't used your vehicle under severe service conditions listed previously and, therefore, haven't changed your automatic transmission fluid, change both the fluid and filter.

| DATE | ACTUAL MILEAGE | SERVICED BY: |
|------|----------------|--------------|
| | | |

Part B: Owner Checks and Services

Listed below are owner checks and services which should be performed at the intervals specified to help ensure the safety, dependability and emission control performance of your vehicle.

Be sure any necessary repairs are completed at once. Whenever any fluids or lubricants are added to your vehicle, make sure they are the proper ones, as shown in Part D.

At Each Fuel Fill

It is important for you or a service station attendant to perform these underhood checks at each fuel fill.

Engine Oil Level Check

Check the engine oil level and add the proper oil if necessary. See "Engine Oil" in the Index for further details.

Engine Coolant Level Check

Check the engine coolant level and add the proper coolant mix if necessary. See "Engine Coolant" in the Index for further details.

Windshield Washer Fluid Level Check

Check the windshield washer fluid level in the windshield washer tank and add the proper fluid if necessary. See "Windshield Washer Fluid" in the Index for further details.

At Least Once a Month

Tire Inflation Check

Make sure tires are inflated to the correct pressures. See "Tires" in the Index for further details.

Cassette Deck Service

Clean cassette deck. Cleaning should be done every 50 hours of tape play. See "Audio Systems" in the Index for further details.

Power Antenna Service

Clean power antenna mast. See "Audio Systems" in the Index for further details.

At Least Twice a Year

Restraint System Check

Make sure the safety belt reminder light and all your belts, buckles, latch plates, retractors and anchorages are working properly. Look for any other loose or damaged safety belt system parts. If you see anything that might keep a safety belt system from doing its job, have it repaired. Have any torn or frayed safety belts replaced.

Also look for any opened or broken air bag covers, and have them repaired or replaced. (The air bag system does not need regular maintenance.)

Manual Transmission Check

Check the transmission fluid level; add if needed. See “Manual Transmission” in the Index. A fluid loss may indicate a problem. Check the system and repair if needed.

Automatic Transmission Check

Check the transmission fluid level; add if needed. See “Automatic Transmission” in the Index. A fluid loss may indicate a problem. Check the system and repair if needed.

At Least Once a Year

Key Lock Cylinders Service

Lubricate the key lock cylinders with the lubricant specified in Part D.

Body Lubrication Service

Lubricate all body door hinges. Also lubricate all hinges and latches, including those for the hood, rear compartment, console door and any folding seat hardware. Part D tells you what to use. More frequent lubrication may be required when exposed to a corrosive environment.

Starter Switch Check

CAUTION:

When you are doing this check, the vehicle could move suddenly. If it does, you or others could be injured. Follow the steps below.

1. Before you start, be sure you have enough room around the vehicle.
2. Firmly apply both the parking brake (see “Parking Brake” in the Index if necessary) and the regular brake.

NOTE: Do not use the accelerator pedal, and be ready to turn off the engine immediately if it starts.

3. On automatic transmission vehicles, try to start the engine in each gear. The starter should work only in PARK (P) or NEUTRAL (N). If the starter works in any other position, your vehicle needs service.

On manual transmission vehicles, put the shift lever in NEUTRAL (N), push the clutch down halfway and try to start the engine. The starter should work only when the clutch is pushed down all the way to the floor. If the starter works when the clutch isn't pushed all the way down, your vehicle needs service.

Brake-Transmission Shift Interlock (BTSI) Check (Automatic Transmission)

CAUTION:

When you are doing this check, the vehicle could move suddenly. If it does, you or others could be injured. Follow the steps below.

1. Before you start, be sure you have enough room around the vehicle. It should be parked on a level surface.
2. Firmly apply the parking brake (see “Parking Brake” in the Index if necessary).

NOTE: Be ready to apply the regular brake immediately if the vehicle begins to move.

3. With the engine off, turn the key to the RUN position, but don't start the engine. Without applying the regular brake, try to move the shift lever out of PARK (P) with normal effort. If the shift lever moves out of PARK (P), your vehicle's BTSI needs service.

Steering Column Lock Check

While parked, and with the parking brake set, try to turn the key to LOCK in each shift lever position.

- With an automatic transmission, the key should turn to LOCK only when the shift lever is in PARK (P).
- With a manual transmission, the key should turn to LOCK only when the shift lever is in REVERSE (R).

On vehicles with a key release button, try to turn the key to LOCK without pressing the button. The key should turn to LOCK only when you press the key button.

On all vehicles, the key should come out only in LOCK.

Parking Brake and Automatic Transmission PARK (P) Mechanism Check

CAUTION:

When you are doing this check, your vehicle could begin to move. You or others could be injured and property could be damaged. Make sure there is room in front of your vehicle in case it begins to roll. Be ready to apply the regular brake at once should the vehicle begin to move.

Park on a fairly steep hill, with the vehicle facing downhill. Keeping your foot on the regular brake, set the parking brake.

- To check the parking brake: With the engine running and transmission in NEUTRAL (N), slowly remove foot pressure from the regular brake pedal. Do this until the vehicle is held by the parking brake only.
- To check the PARK (P) mechanism's holding ability: Shift to PARK (P). Then release all brakes.

Underbody Flushing Service

At least every spring, use plain water to flush any corrosive materials from the underbody. Take care to clean thoroughly any areas where mud and other debris can collect.

Part C: Periodic Maintenance Inspections

Listed below are inspections and services which should be performed at least twice a year (for instance, each spring and fall). You should let your GM dealer's service department or other qualified service center do these jobs. Make sure any necessary repairs are completed at once.

Proper procedures to perform these services may be found in a Corvette service manual. See "Service and Owner Publications" in the Index.

Steering and Suspension Inspection

Inspect the front and rear suspension and steering system for damaged, loose or missing parts, signs of wear, or lack of lubrication. Inspect the power steering lines and hoses for proper hook-up, binding, leaks, cracks, chafing, etc.

Tire and Wheel Inspection

Inspect the tires for uneven wear or damage. If there is irregular or premature wear, check the wheel alignment. Inspect for damaged wheels.

Exhaust System Inspection

Inspect the complete exhaust system. Inspect the body near the exhaust system. Look for broken, damaged, missing or out-of-position parts as well as open seams, holes, loose connections, or other conditions which could cause a heat build-up in the floor pan or could let exhaust fumes into the vehicle. See “Engine Exhaust” in the Index.

Radiator and Heater Hose Inspection

Inspect the hoses and have them replaced if they are cracked, swollen or deteriorated. Inspect all pipes, fittings and clamps; replace as needed.

Throttle Linkage Inspection

Inspect the throttle linkage for interference or binding, and for damage or missing parts. Replace parts as needed. Replace any cables that have high effort or excessive wear. Do not lubricate accelerator and cruise control cables.

Rear Axle Service

Check the gear lubricant level in the rear axle and add if needed. See “Rear Axle” in the Index. A fluid loss may indicate a problem. Check the axle and repair it if needed.

Brake System Inspection

Inspect the complete system. Inspect brake lines and hoses for proper hook-up, binding, leaks, cracks, chafing, etc. Inspect disc brake pads for wear and rotors for surface condition. Inspect other brake parts, including calipers, parking brake, etc. You may need to have your brakes inspected more often if your driving habits or conditions result in frequent braking.

Part D: Recommended Fluids and Lubricants

NOTE: Fluids and lubricants identified below by name, part number or specification may be obtained from your GM dealer.

| USAGE | FLUID/LUBRICANT |
|------------|---|
| Engine Oil | The engine requires a special oil meeting GM Standard GM4718M. Oils meeting this Standard may be identified as synthetic, and should also be identified with the American Petroleum Institute Certified For Gasoline Engines "Starburst" symbol. However, not all Synthetic API oils with the "Starburst" symbol will meet this GM Standard. You should look for and use only an oil that meets GM Standard GM4718M. For the proper viscosity, see "Engine Oil" in the Index. |

| USAGE | FLUID/LUBRICANT |
|----------------------------|---|
| Engine Coolant | 50/50 mixture of water (preferably distilled) and GM Goodwrench [®] DEX-COOL™ or Havoline [®] DEX-COOL™ (orange-colored, silicate-free) antifreeze conforming to GM Specification 6277M. See "Engine Coolant" in the Index. |
| Coolant Supplement Sealer | GM Part No. 3634621 or equivalent with a complete flush and refill. |
| Hydraulic Brake System | Delco Supreme 11 [®] Brake Fluid (GM Part No. 1052535 or equivalent DOT-3 brake fluid). |
| Hydraulic Clutch System | Hydraulic Clutch Fluid (GM Part No. 12345347 or equivalent). |
| Parking Brake Cable Guides | Chassis lubricant (GM Part No. 1052497 or equivalent) or lubricant meeting requirements of NLGI Grade 2, Category LB or GC-LB. |

| USAGE | FLUID/LUBRICANT |
|-----------------------------------|--|
| Power Steering System | GM Synthetic Power Steering Fluid (GM Part No. 12345866 or 12345867 or equivalent). |
| Manual Transmission | Manual Transmission Fluid SAE 5W-30 (GM Part No. 1052931 or equivalent). |
| Automatic Transmission | DEXRON [®] -III Automatic Transmission Fluid. |
| Key Lock Cylinders | Multi-Purpose Lubricant, Superlube [®] (GM Part No. 12346241 or equivalent). |
| Manual Transmission Shift Linkage | Chassis lubricant (GM Part No. 1052497 or equivalent) or lubricant meeting requirements of NLGI Grade 2, Category LB or GC-LB. |
| Clutch Linkage Pivot Points | Engine oil. |

| USAGE | FLUID/LUBRICANT |
|---------------------------------------|---|
| Floor Shift Linkage | Lubriplate Lubricant aerosol (GM Part No. 12346293 or equivalent) or lubricant meeting requirements of NLGI Grade 2 Category LB or GC-LB. |
| Chassis Lubrication | Chassis lubricant (GM Part No. 1052497 or equivalent) or lubricant meeting requirements of NLGI Grade 2, Category LB or GC-LB. |
| Rear Axle (Limited-Slip Differential) | Axle Lubricant (GM Part No. 12345977) and 4 ounces (118 ml) of Limited-Slip Differential Lubricant Additive (GM Part No. 1052358 or equivalent) where required. See "Rear Axle" in the Index. |
| Windshield Washer Solvent | GM Optikleen [®] Washer Solvent (GM Part No. 1051515) or equivalent. |

| USAGE | FLUID/LUBRICANT |
|--|--|
| Hood Latch Assembly Pivots, Spring Anchor and Release Pawl | Lubriplate lubricant aerosol (GM Part No. 12346293 or equivalent) or lubricant meeting requirements of NLGI Grade 2, Category LB or GC-LB. |
| Hood and Door Hinges | Multi-purpose lubricant, Superlube [®] (GM Part No. 12346241 or equivalent). |

| USAGE | FLUID/LUBRICANT |
|------------------------------|--|
| Weatherstrip Conditioning | Dielectric Silicone Grease (GM Part No. 12345579 or equivalent). |

See "Replacement Parts" in the Index for recommended replacement filters and spark plugs.

Part E: Maintenance Record

After the scheduled services are performed, record the date, odometer reading and who performed the service in the boxes provided after the maintenance interval. Any additional information from “Owner Checks and

Services” or “Periodic Maintenance” can be added on the following record pages. Also, you should retain all maintenance receipts. Your owner information portfolio is a convenient place to store them.

| Maintenance Record | | | |
|---------------------------|-------------------------|--------------------|------------------------------|
| DATE | ODOMETER READING | SERVICED BY | MAINTENANCE PERFORMED |
| | | | |
| | | | |
| | | | |
| | | | |
| | | | |
| | | | |
| | | | |
| | | | |
| | | | |
| | | | |

Maintenance Record

| DATE | ODOMETER READING | SERVICED BY | MAINTENANCE PERFORMED |
|------|---------------------|-------------|-----------------------|
| | | | |
| | | | |
| | | | |
| | | | |
| | | | |
| | | | |
| | | | |
| | | | |
| | | | |
| | | | |
| | | | |
| | | | |
| | | | |
| | | | |
| | | | |
| | | | |



Section 8 Customer Assistance Information

Here you will find out how to contact Chevrolet if you need assistance. This section also tells you how to obtain service publications and how to report any safety defects.

This section includes information on:

- The Customer Satisfaction Procedure
- Customer Assistance for Text Telephone (TTY) Users
- The Corvette Action Center
- Roadside Assistance
- Courtesy Transportation
- BBB Auto Line - Alternative Dispute Resolution Program
- Reporting Safety Defects
- Service and Owner Publications

Customer Satisfaction Procedure



Your satisfaction and goodwill are important to your dealer and Chevrolet. Normally, any concern you may have with your vehicle can be handled by your selling or servicing dealer. Your dealer has the facility, trained technicians, special tools and up-to-date information to promptly address any issue which may arise. Chevrolet has empowered its dealers to make decisions and repair vehicles, and they are eager to resolve your concern to your complete satisfaction. If your concern has not been resolved to your satisfaction, take the following steps:

STEP ONE -- Discuss your concern with a member of dealership management. Normally, concerns can be quickly resolved at that level. If the matter has already been reviewed with the Sales, Service, or Parts Manager, contact the owner of the dealership or the General Manager.

STEP TWO -- If after contacting a member of dealership management, it appears your concern cannot be resolved by the dealership without further help, contact the Chevrolet Customer Assistance Center by calling 1-800-222-1020. In Canada, contact GM of Canada Customer Assistance Center in Oshawa by calling 1-800-263-3777 (English) or 1-800-263-7854 (French).

For help outside of the United States and Canada, call the following numbers as appropriate:

- In Mexico: (525) 625-3256
- In Puerto Rico: 1-800-496-9992 (English) or 1-800-496-9993 (Spanish)
- In the U.S. Virgin Islands: 1-800-496-9994
- In the Dominican Republic: 1-800-751-4135 (English) or 1-800-751-4136 (Spanish)
- In the Bahamas: 1-800-389-0009
- In Bermuda, Barbados, Antigua and the British Virgin Islands: 1-800-534-0122
- In all other Caribbean countries: 1-809-763-1315
- In other overseas locations, call GM North American Export Sales in Canada at 1-905-644-4112

For prompt assistance, please have the following information available to give the Customer Assistance Representative:

- Your name, address, home and business telephone numbers
- Vehicle Identification Number (This is available from the vehicle registration or title, or the plate at the top left of the instrument panel and visible through the windshield.)
- Dealership name and location
- Vehicle delivery date and present mileage
- Nature of concern

We encourage you to call us so we can give your inquiry prompt attention. However, if you wish to write Chevrolet, write to:

Chevrolet Motor Division
Chevrolet Customer Assistance Center
P.O. Box 7047
Troy, MI 48007-7047

Refer to your Warranty and Owner Assistance Information booklet for addresses of Canadian and GM Overseas offices.

When contacting Chevrolet, please remember that your concern will likely be resolved in the dealership, using the dealer's facilities, equipment and personnel. That is why we suggest you follow Step One first if you have a concern.

Customer Assistance for Text Telephone (TTY) Users

To assist customers who are deaf, hard of hearing, or speech-impaired and who use Text Telephones (TTYs), Corvette has TTY equipment available at its Customer Assistance Center. Any TTY user can communicate with Corvette by dialing: 1-800-833-CHEV (1-800-833-2438). (TTY users in Canada can dial 1-800-263-3830.)

Corvette Action Center

If you have any questions, comments or problems regarding your Corvette in general, you can call the Corvette Action Center at 1-800-457-VETT. The Corvette Action Center is open between the hours of 6:00 a.m. to 2:30 p.m. CST, Monday through Friday.

Chevrolet Roadside Assistance Program

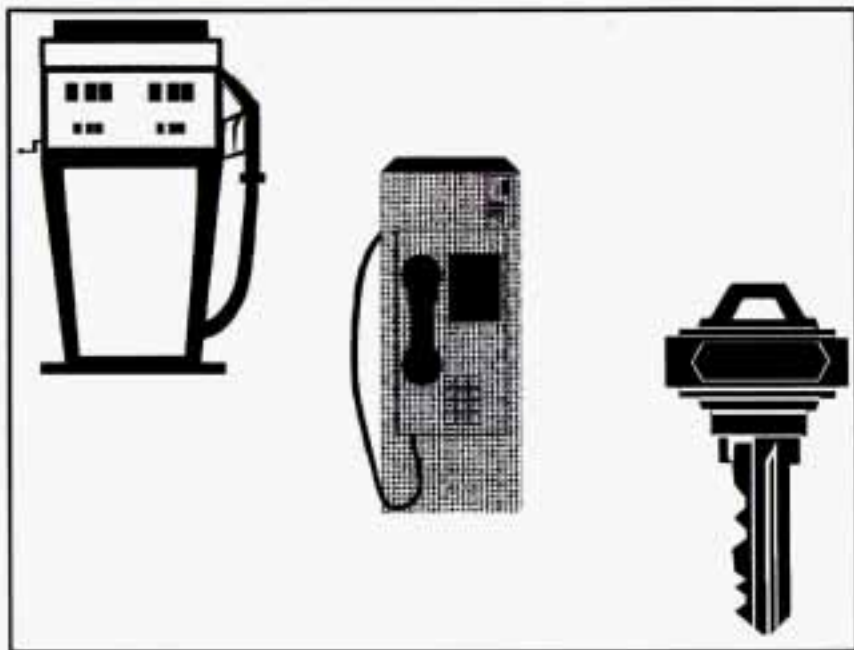

Available in the United States and Canada only to enhance Chevrolet's strong commitment to customer satisfaction, Chevrolet is excited to announce the establishment of the Chevrolet/Geo Roadside Assistance Center. As the owner of a 1996 Chevrolet/Geo, membership in Roadside Assistance is free.

Roadside Assistance is available 24 hours a day, 365 days a year, by calling 1-800-CHEV-USA (1-800-243-8872). This toll-free number will provide you over-the-phone roadside assistance with minor mechanical problems. If your problem cannot be resolved over the phone, our advisors have access to a nationwide network of dealer recommended service providers. Roadside membership is free, however, some services may incur costs.

Roadside offers two levels of service to the customer, *Basic Care* and *Courtesy™ Care*:

- Toll-free number, 1-800-CHEV-USA
- Free towing for warranty repairs
- Basic over-the-phone technical advice
- Available dealer services at reasonable costs (i.e., wrecker services, locksmith/key service, glass repair, etc.)

ROADSIDE *Courtesy Care* PROVIDES:

- Roadside *Basic Care* services (as outlined above)
Plus:
- FREE Non-Warranty Towing (to the closest dealer from a legal roadway)
- FREE Locksmith/Key Service (when keys are lost on the road or locked inside)
- FREE Flat Tire Service (spare installed on the road)
- FREE Jump Start (at home or on the road)
- FREE Fuel Delivery (\$5 of fuel delivered on the road)

Chevrolet/Geo offers *Courtesy Transportation* for customers needing warranty service. *Courtesy Transportation* will be offered in conjunction with the coverage provided by the BUMPER-TO-BUMPER New Vehicle Limited Warranty to eligible purchasers of 1996 Chevrolet/Geo passenger car and light duty trucks. (Please see your selling dealer for details.)

Note: *Courtesy Care* is available to Retail and Retail Lease Customers operating 1994 and newer Chevrolet/Geo vehicles for a period of 36 months/36,000 miles. All *Courtesy Care* services must be pre-arranged by Chevrolet Roadside or Dealer Service Management.

Basic Care and *Courtesy Care* are not part of or included in the coverage provided by the New Vehicle Limited Warranty. Chevrolet reserves the right to modify or discontinue *Basic Care* and *Courtesy Care* at any time.

For complete program details, see your Chevrolet/Geo dealer to obtain a Roadside Assistance Center brochure.

The Roadside Assistance Center uses companies that will provide you with quality and priority service. When roadside services are required, our advisors will explain any payment obligations that may be incurred for utilizing outside services.

For prompt assistance when calling, please have the following available to give to the advisor:

- Vehicle Identification Number
- License plate number
- Vehicle color
- Vehicle location
- Telephone number where you can be reached
- Vehicle mileage
- Description of problem

Please refer to the Roadside Assistance brochure inside your owner information portfolio for full program details.

In Canada, please consult your GM dealer for information on Courtesy Transportation.

Some state insurance regulations make it impractical to rent vehicles to people under 21 years of age. If you are under 21 and have difficulty renting a vehicle, Chevrolet will reimburse up to \$30/day for documented transportation you receive.

In Canada, for warranty repairs during the Complete Vehicle Coverage period in the New Vehicle Limited Warranty, interim transportation may be available under the Courtesy Transportation Program. Please consult your dealer for details.

Canadian Roadside Assistance

Vehicles purchased in Canada have an extensive Roadside Assistance program accessible from anywhere in Canada or the United States. Please refer to the separate brochure provided by the dealer or call 1-800-268-6800 for emergency services.

Courtesy Transportation

Available in the United States and Canada only, Chevrolet/Geo offers Courtesy Transportation for customers needing warranty service. Courtesy Transportation will be offered in conjunction with the coverage provided by the BUMPER-TO-BUMPER New Vehicle Limited Warranty to retail purchasers of 1996 Chevrolet/Geo passenger cars and light duty trucks (please see your selling dealer for details).

Courtesy Transportation includes:

- One way shuttle ride for any warranty repair completed during the same day.
- Up to \$30 maximum daily vehicle rental allowance for any overnight warranty repair up to 5 days, OR
- Up to \$30 maximum daily cab, bus, or other transportation allowance in lieu of rental for any overnight warranty repair up to 5 days, OR
- Up to \$10 daily fuel allowance for rides provided by another person (i.e., friend, neighbor, etc.) in lieu of rental for any overnight warranty repair up to 5 days.

Note: All Courtesy Transportation arrangements will be administered by your Chevrolet/Geo dealer service management. Claim amounts should reflect all actual costs.

- Chevrolet/Geo Courtesy Transportation is not part of the BUMPER-TO-BUMPER New Vehicle Limited Warranty. Chevrolet/Geo reserves the right to make any changes or discontinue Courtesy Transportation at any time without notification.
- For additional program details contact your Chevrolet/Geo dealer.

GM Participation in BBB AUTO LINE - Alternative Dispute Resolution Program*

*This program may not be available in all states, depending on state law. Canadian owners refer to your Warranty and Owner Assistance Information booklet. General Motors reserves the right to change eligibility limitations and/or to discontinue its participation in this program.

Both Chevrolet and your Chevrolet dealer are committed to making sure you are completely satisfied with your new vehicle. Our experience has shown that, if a situation arises where you feel your concern has not been adequately addressed, the Customer Satisfaction Procedure described earlier in this section is very successful.

There may be instances where an impartial third party can assist in arriving at a solution to a disagreement regarding vehicle repairs or interpretation of the New Vehicle Limited Warranty. To assist in resolving these disagreements, Chevrolet voluntarily participates in BBB AUTO LINE.

BBB AUTO LINE is an out-of-court program administered by the Better Business Bureau system to settle disputes between customers and automobile manufacturers. This program is available free of charge to customers who currently own or lease a GM vehicle.

If you are not satisfied after following the Customer Satisfaction Procedure, you may contact the BBB using the toll-free telephone number, or write them at the following address:

BBB AUTO LINE
Council of Better Business Bureaus
4200 Wilson Boulevard
Suite 800
Arlington, VA 22203
Telephone: 1-800-955-5100

To file a claim, you will be asked to provide your name and address, your Vehicle Identification Number (VIN), and a statement of the nature of your complaint. Eligibility is limited by vehicle age and mileage, and other factors.

We prefer you utilize the Customer Satisfaction Procedure before you resort to AUTO LINE, but you may contact the BBB at any time. The BBB will attempt to resolve the complaint serving as an intermediary between you and Chevrolet. If this mediation is unsuccessful, an informal hearing will be scheduled where eligible customers may present their case to an impartial third-party arbitrator.

The arbitrator will make a decision which you may accept or reject. If you accept the decision, GM will be bound by that decision. The entire dispute resolution procedure should ordinarily take about 40 days from the time you file a claim until a decision is made.

Some state laws may require you to use this program before filing a claim with a state-run arbitration program or in the courts. For further information, contact the BBB at 1-800-955-5100 or the Chevrolet Customer Assistance Center at 1-800-222-1020.

REPORTING SAFETY DEFECTS TO THE UNITED STATES GOVERNMENT

If you believe that your vehicle has a defect which could cause a crash or could cause injury or death, you should immediately inform the National Highway Traffic Safety Administration (NHTSA), in addition to notifying General Motors.

If NHTSA receives similar complaints, it may open an investigation, and if it finds that a safety defect exists in a group of vehicles, it may order a recall and remedy campaign. However, NHTSA cannot become involved in individual problems between you, your dealer, or General Motors.

To contact NHTSA, you may either call the Auto Safety Hotline toll-free at 1-800-424-9393 (or 366-0123 in the Washington, D.C. area) or write to:

NHTSA, U.S. Department of Transportation
Washington, D.C. 20590

You can also obtain other information about motor vehicle safety from the Hotline.

REPORTING SAFETY DEFECTS TO THE CANADIAN GOVERNMENT

If you live in Canada, and you believe that your vehicle has a safety defect, you should immediately notify Transport Canada, in addition to notifying General Motors of Canada Limited. You may write to:

Transport Canada
Box 8880
Ottawa, Ontario K1G 3J2

REPORTING SAFETY DEFECTS TO GENERAL MOTORS

In addition to notifying NHTSA (or Transport Canada) in a situation like this, we certainly hope you'll notify us. Please call us at 1-800-222-1020, or write:

Chevrolet Customer Assistance Center
P. O. Box 7047
Troy, Michigan 48007-7047

In Canada, please call us at 1-800-263-3777 (English) or 1-800-263-7854 (French). Or, write:

General Motors of Canada Limited
Customer Assistance Center
1908 Colonel Sam Drive
Oshawa, Ontario L1H 8P7

Service and Owner Publications



Service manuals, service bulletins, owner's manuals and other service literature are available for purchase for all current and many past model General Motors vehicles.

Toll-free telephone numbers for ordering information:

United States 1-800-551-4123

Canada 1-800-668-5539

Service Manuals

Service manuals contain diagnostic and repair information for all chassis and body systems. They may be useful for owners who wish to get a greater understanding of their vehicle. They are also useful for owners with the appropriate skill level or training who wish to perform “do-it-yourself” service. These are authentic General Motors service manuals meant for professional, qualified technicians.

Service Bulletins

Service bulletins covering various subjects are regularly sent to all General Motors dealers. GM monitors product performance in the field. When service methods are found which promote better service on GM vehicles, bulletins are created to help the technician perform better service. Service bulletins may involve any

number of vehicles. Some will describe inexpensive service; others will describe expensive service. Some will advise of new or unexpected conditions, and others may help avoid future costly repairs. Service bulletins are meant for qualified technicians. In some cases bulletins refer to service manuals, specialized tools, equipment and safety procedures necessary to service the vehicle. Since these bulletins are issued throughout the model year and beyond, an index is required and published quarterly to help identify specific bulletins. Subscriptions are available. You can order an index at the toll-free numbers listed previously, or ask a GM dealer to see an index or individual bulletin.

Owner Publications

Owner’s manuals, warranty folders and various owner assistance booklets provide owners with general operation and maintenance information.

NOTES



Section 9 Index

| | | | |
|--|---------------|---|------------|
| Accessory Plug | 2-52 | Appearance Care Materials | 6-62 |
| Air Bag | 1-17 | Arbitration Program | 8-7 |
| How Does it Restrain | 1-21 | Ashtray | 2-50 |
| How it Works | 1-19 | ASR Active Light | 2-81, 4-8 |
| Location | 1-19 | ASR Off Light | 2-81 |
| Servicing | 1-22 | ASR System | 4-8 |
| What Makes it Inflate | 1-20 | ASR System Warning Light | 2-80, 4-8 |
| What Will You See After it Inflates | 1-21 | Audio Equipment, Adding | 3-18 |
| When Should it Inflate | 1-20 | Audio Systems | 3-10 |
| Air Bag Readiness Light | 1-18, 2-76 | Automatic | |
| Air Bag System | 1-17 | Electronic Climate Control System | 3-4 |
| Air Cleaner | 6-15 | Overdrive | 2-23 |
| Air Conditioning | 3-2, 3-3, 3-7 | Transmission | 2-18, 2-21 |
| Alarm, Theft-Deterrent | 2-13 | Transmission Check | 7-41 |
| Alignment and Balance, Tire | 6-52 | Transmission Fluid | 6-18 |
| Aluminum Wheels, Cleaning | 6-60 | Transmission Park Mechanism Check | 7-43 |
| Antenna, Power | 3-20 | Transmission, Fluid Temperature Reading | 2-97 |
| Antifreeze | 6-25 | Transmission, Operation | 2-21 |
| Anti-Lock Brake System Active Light | 2-80, 4-8 | Transmission, Shifting | 2-21 |
| Anti-Lock Brake System Warning Light | 2-79, 4-6 | Transmission, Starting Your Engine | 2-18 |
| Anti-Lock Brakes | 4-6 | Axle, Limited-Slip Rear | 2-28 |
| Appearance Care | 6-54 | Axle, Rear | 6-24 |

| | | | |
|--|----------|---|------------------|
| B ack-up Lamp Bulb Replacement | 6-43 | C anadian Roadside Assistance | 8-6 |
| Battery | 6-35 | Capacities and Specifications | 6-74 |
| Jump Starting | 5-2 | Carbon Monoxide | 2-32, 4-27 |
| Replacement, Passive Keyless Entry | 2-8 | Cassette Deck Service | 7-40 |
| Warnings | 5-2, 5-4 | Cassette Tape Player | 3-11, 3-13, 3-15 |
| BBB Auto Line | 8-7 | Cassette Tape Player Care | 3-19 |
| Belt, Engine Accessory | 6-79 | Center Console | 2-48 |
| Better Business Bureau Mediation | 8-7 | Center High-Mounted Stoplamp Bulb Replacement | 6-41 |
| B rake | | Certification Label | 4-28 |
| Adjustment | 6-34 | Chains, Tire | 6-53 |
| Fluid | 6-32 | Changing a Flat Tire | 5-22 |
| Master Cylinder | 6-32 | Charging System Indicator Light | 2-76 |
| Parking | 2-28 | Check Gauges Light | 2-93 |
| Pedal Travel | 6-34 | Checking Your Restraint Systems | 1-31 |
| Replacing System Parts | 6-35 | Chemical Paint Spotting | 6-61 |
| System Warning Light | 2-78 | Child Restraints | 1-26 |
| Transmission Shift Interlock | 2-31 | Securing in the Passenger Seat Position | 1-26 |
| Wear | 6-34 | Top Strap | 1-26 |
| Brakes, Anti-Lock | 4-6 | Where to Put | 1-26 |
| Brake-Transmission Shift Interlock Check | 7-42 | Cigarette Lighter | 2-50 |
| Braking | 4-5 | Circuit Breakers and Fuses | 6-65 |
| Braking in Emergencies | 4-9 | Cleaner, Air | 6-15 |
| Break-In, New Vehicle | 2-15 | C leaning | |
| BTSI | 2-31 | Aluminum Wheels | 6-60 |
| BTSI Check | 7-42 | Coated Moldings | 6-55 |
| Bulb Replacement | 6-36 | Convertible Hardtop | 6-60 |
| Bulbs, Replacement | 6-73 | Convertible Top | 6-59 |

| | | | |
|---|------|--|------------|
| Fabric | 6-55 | Convex Outside Mirror | 2-47 |
| Glass | 6-56 | Coolant | 5-17, 6-25 |
| Inside of Your Corvette | 6-54 | High Fill Reservoir | 5-19 |
| Instrument Panel | 6-56 | High Fill Reservoir Cap | 6-29 |
| Leather | 6-55 | Recovery Tank | 5-17 |
| Outside of Your Corvette | 6-58 | Coolant Heater, Engine | 2-20 |
| Removable Roof Panels | 6-57 | Cooling System | 5-15 |
| Soft-Touch Paint Surfaces | 6-56 | Cornering Lamp Bulb Replacement | 6-40 |
| Speaker Covers | 6-56 | Corvette Action Center | 8-3 |
| Stains | 6-54 | Courtesy Lamps | 2-45 |
| Tires | 6-60 | Courtesy Transportation | 8-6 |
| Vinyl | 6-55 | Cruise Control | 2-38 |
| Weatherstrips | 6-57 | Customer Assistance for Text Telephone Users | 8-3 |
| Wheels | 6-60 | Customer Assistance Information | 8-1 |
| Windshield and Wiper Blades | 6-57 | Customer Satisfaction Procedure | 8-1 |
| Climate Control, Automatic Electronic | 3-4 | | |
| Climate Control, Manual | 3-1 | D amage, Finish | 6-60 |
| Clock, Setting the | 3-10 | Daytime Running Lamps | 2-44 |
| Clutch, Hydraulic | 6-22 | Dead Battery | 5-2 |
| Comfort Controls | 3-1 | Defects, Reporting Safety | 8-9 |
| Compact Disc Care | 3-19 | Defensive Driving | 4-1 |
| Compact Disc Player | 3-15 | Defogger, Rear Window | 3-8 |
| Compact Spare Tire | 5-38 | Defogging | 3-3, 3-7 |
| Competitive Driving | 2-19 | Defrosting | 3-3, 3-7 |
| Console, Center | 2-48 | Delayed Accessory Bus (DAB) | 2-17 |
| Control of a Vehicle | 4-5 | Dimensions, Vehicle | 6-77 |
| Convertible Hardtop | 2-64 | Dolby B Noise Reduction | 3-10 |
| Convertible Top | 2-58 | | |

| | |
|--------------------------------------|------------------|
| Door | |
| Ajar Light | 2-94 |
| Flood Lamps | 2-45 |
| Locks | 2-3 |
| Storage | 2-47 |
| Downshifting | 2-26 |
| Drive, Automatic Transmission | 2-23 |
| Driver Information Center | 2-98 |
| Driver Position | 1-11 |
| Driving | 4-1 |
| City | 4-19 |
| Defensive | 4-1 |
| Drunken | 4-2 |
| Freeway | 4-20 |
| In a Blizzard | 4-26 |
| In Foreign Countries | 6-4 |
| In the Rain | 4-16 |
| Night | 4-15 |
| On Curves | 4-10 |
| On Hill and Mountain Roads | 4-22 |
| On Snow and Ice | 4-25 |
| Through Deep Water | 4-18 |
| Wet Roads | 4-16 |
| Winter | 4-24 |
| Drunken Driving | 4-2 |
| E lectrical Equipment, Adding | 2-19, 3-18, 6-64 |
| Electrical System | 6-64 |
| Electronic Climate Control System | 3-4 |

| | |
|---------------------------|------|
| EMT | 6-47 |
| Engine | 6-8 |
| Accessory Belt | 6-79 |
| Coolant | 6-25 |
| Coolant Heater | 2-20 |
| Coolant Level Check | 7-40 |
| Coolant Temperature Gauge | 2-82 |
| Exhaust | 2-32 |
| Fuse Blocks | 6-69 |
| Identification | 6-63 |
| Oil | 6-10 |
| Oil, Adding | 6-11 |
| Oil, Additives | 6-13 |
| Oil, Checking | 6-11 |
| Oil Level Check | 7-40 |
| Oil, Life Monitor | 2-91 |
| Oil, Temperature Gauge | 2-90 |
| Oil, Used | 6-14 |
| Oil, When to Change | 6-14 |
| Overheating | 5-13 |
| Running While Parked | 2-33 |
| Specifications | 6-74 |
| Starting Your | 2-18 |
| Oil, Pressure Gauge | 2-89 |
| English/Metric Button | 2-74 |
| Ethanol | 6-4 |
| Exhaust, Engine | 2-32 |
| Express-Down Window | 2-34 |
| Extended Mobility Tires | 6-47 |

| | |
|---|----------|
| F abric Cleaning | 6-55 |
| Fabric Protection | 6-55 |
| Fan Control Buttons | 3-1, 3-4 |
| Fiberglass Springs | 6-61 |
| Fifth Gear, Manual Transmission | 2-24 |
| Filling Your Tank | 6-5 |
| Filter, Air Cleaner | 6-15 |
| Finish Care | 6-58 |
| Finish Damage | 6-60 |
| First Gear, Automatic Transmission | 2-23 |
| First Gear, Manual Transmission | 2-24 |
| Flashers, Hazard Warning | 5-1 |
| Flat Tire, Changing | 5-22 |
| Fluid Capacities | 6-76 |
| Fluids and Lubricants | 7-46 |
| Fog Lamp Bulb Replacement | 6-40 |
| Fog Lamps | 2-44 |
| Foreign Countries, Fuel | 6-4 |
| Fourth Gear, Manual Transmission | 2-24 |
| French Language Manual | ii |
| Front Towing | 5-8 |
| Front Turn Signal Lamp Bulb Replacement | 6-38 |
| Fuel | 6-3 |
| Canada | 6-4 |
| Gauge | 2-94 |
| In Foreign Countries | 6-4 |
| Fuel, Filling Your Tank | 6-5 |
| Fuses and Circuit Breakers | 6-65 |

| | |
|---|------------|
| G auge Markings | 2-96 |
| Gauges | |
| Engine Coolant Temperature | 2-82 |
| Engine Oil Pressure | 2-89 |
| Engine Oil Temperature | 2-90 |
| Fuel | 2-94 |
| GAWR | 4-28 |
| Gear Positions | 2-21, 2-24 |
| Gross Axle Weight Rating | 4-28 |
| Gross Vehicle Weight Rating | 4-28 |
| Guide en Français | ii |
| GVWR | 4-28 |
| H alogen Bulbs | 6-36 |
| Hardtop, Convertible | 2-64 |
| Hazard Warning Flashers | 5-1 |
| Headlamp Bulb Replacement | 6-36 |
| Headlamp Doors | 2-43 |
| Headlamps | 2-42 |
| High/Low Beam Changer | 2-36 |
| Wiring | 6-64 |
| Hearing Impaired, Customer Assistance | 8-3 |
| Heating | 3-2, 3-6 |
| Heritage Pages | iii |
| High-Beam Lamps | 2-36 |
| Highway Hypnosis | 4-22 |
| Hill and Mountain Roads | 4-22 |

| | |
|-----------------------------|------|
| Hood | 6-7 |
| Checking Things Under | 6-7 |
| Release | 6-7 |
| Horn | 2-34 |
| Hydraulic Clutch | 6-22 |
| Hydroplaning | 4-18 |

| | |
|--|------|
| I gnition Switch | 2-16 |
| Inflation, Tire | 6-48 |
| Inside Day/Night Rearview Mirror | 2-46 |
| Inspections | 7-44 |
| Brake System | 7-45 |
| Exhaust System | 7-45 |
| Radiator and Heater Hose | 7-45 |
| Steering | 7-44 |
| Suspension | 7-44 |
| Throttle Linkage | 7-45 |
| Tire | 7-44 |
| Wheel | 7-44 |
| Instrument Panel | 2-70 |
| Brightness Control | 2-45 |
| Cleaning | 6-56 |
| Cluster | 2-72 |
| Fuse Block | 6-65 |
| Interior Lamps | 2-45 |
| | |
| J ack, Tire | 5-23 |
| Jump Starting | 5-2 |

| | |
|--|------|
| K ey Lock Cylinders Service | 7-41 |
| Key Release Button | 2-17 |
| Keys | 2-1 |

| | |
|--|------------|
| L abels | 4-28 |
| Certification | 4-28 |
| Service Parts Identification | 6-63 |
| Tire-Loading Information | 4-28 |
| Vehicle Identification Number | 6-63 |
| Lamps | 2-42 |
| Courtesy | 2-45 |
| Interior | 2-45 |
| On Reminder | 2-43 |
| Latches, Seatback | 1-5 |
| Leaving Your Vehicle | 2-4 |
| Leaving Your Vehicle with the Engine Running | 2-30 |
| Lighter | 2-50 |
| Lights | |
| Air Bag Readiness | 1-18, 2-76 |
| Anti-Lock Brake System Active | 2-80, 4-8 |
| Anti-Lock Brake System Warning | 2-79, 4-6 |
| ASR Active | 2-81, 4-8 |
| ASR Off | 2-81 |
| ASR System Warning | 2-80, 4-8 |
| Brake System Warning | 2-78 |
| Charging System Indicator | 2-76 |
| Check Gauges | 2-93 |
| Door Ajar | 2-94 |
| Low Coolant Warning | 2-83, 6-27 |
| Low Oil | 2-88 |

| | | | |
|----------------------------------|------------|---|------------|
| Low Tire Pressure Warning | 2-83 | Recommended Fluids and Lubricants | 7-46 |
| Parking Brake Indicator | 2-79 | Scheduled Maintenance Services | 7-3 |
| Passive Keyless Entry | 2-92 | Short Trip/City Definition | 7-4 |
| Safety Belt Reminder | 1-6, 2-75 | Short Trip/City Intervals | 7-4, 7-6 |
| Security | 2-93 | Maintenance, Underbody | 6-61 |
| Service ASR | 2-80, 4-9 | Malfunction Indicator Lamp | 2-86 |
| Service Engine Soon | 2-86 | Manual | |
| Service LTPWS | 2-85 | Climate Control System | 3-1 |
| Service Ride Control | 2-92 | Front Seat | 1-1 |
| System Problems | 2-93 | Transmission | 2-18, 2-24 |
| Loading Your Vehicle | 4-28 | Transmission Check | 7-41 |
| Locks | 2-3 | Transmission Fluid | 6-21 |
| Cylinders | 7-41 | Transmission, Shifting | 2-24 |
| Door | 2-3 | Transmission, Starting Your Engine | 2-18 |
| Key Lock Cylinders Service | 7-41 | Map Lamps | 2-45 |
| Power Door | 2-4 | Methanol | 6-4 |
| Steering Column Lock Check | 7-43 | Mirrors | 2-46 |
| Low Coolant Warning Light | 2-83, 6-27 | Convex Outside | 2-47 |
| Low Oil Light | 2-88 | Inside Day/Night Rearview | 2-46 |
| Low Tire Pressure Warning Light | 2-83 | Power Remote Control | 2-46 |
| Lubricants and Fluids | 7-46 | Visor Vanity | 2-51 |
| Lubrication Service, Body | 7-41 | MMT | 6-4 |
| M aintenance Record | 7-49 | Mountain Roads | 4-22 |
| Maintenance Schedule | 7-1 | Multifunction Lever | 2-35 |
| Long Trip/Highway Definition | 7-5 | N eutral, Automatic Transmission | 2-22 |
| Long Trip/Highway Intervals | 7-5, 7-28 | Neutral, Manual Transmission | 2-24 |
| Owner Checks and Services | 7-40 | New Vehicle Break-In | 2-15 |
| Periodic Maintenance Inspections | 7-44 | Night Vision | 4-15 |

| | | | |
|---|------|---|------|
| O dometer | 2-74 | Plug, Accessory | 2-52 |
| Odometer, Trip | 2-74 | Power | |
| Off-Road Recovery | 4-12 | Door Locks | 2-4 |
| Oil, Engine | 6-10 | Remote Control Mirrors | 2-46 |
| One to Four Light | 2-25 | Seat | 1-2 |
| Overdrive, Automatic Transmission | 2-23 | Steering | 4-10 |
| Overheating Engine | 5-13 | Steering Fluid | 6-29 |
| Owner Checks and Services | 7-40 | Windows | 2-34 |
| Owner Publications, Ordering | 8-11 | Power Antenna Service | 7-40 |
| P aint Spotting, Chemical | 6-61 | Power Seat | 1-2 |
| P ark | | Pregnancy, Use of Safety Belts | 1-23 |
| Automatic Transmission | 2-21 | Problems on the Road | 5-1 |
| Shifting Into | 2-29 | Publications, Service and Owner | 8-10 |
| Shifting Out of | 2-31 | R acing or Other Competitive Driving | 2-19 |
| P arking | | Radio Reception | 3-18 |
| At Night | 2-12 | Radios | 3-10 |
| Brake | 2-28 | Rain, Driving In | 4-16 |
| Lots | 2-12 | R ear | |
| Over Things That Burn | 2-32 | Axle | 6-24 |
| Your Vehicle, Manual Transmission | 2-31 | Axle Service | 7-45 |
| Parking Brake Indicator Light | 2-79 | Cargo Compartment Lamp Bulb Replacement | 6-44 |
| Parking Brake Mechanism Check | 7-43 | Storage | 2-49 |
| Passenger Position | 1-23 | Towing | 5-10 |
| Passing | 4-12 | Turn Signal Lamp Bulb Replacement | 6-42 |
| Passive Keyless Entry Light | 2-92 | Window Defogger | 3-8 |
| Passive Keyless Entry System | 2-4 | Rearview Mirror, Inside Day/Night | 2-46 |
| Pass-Key [®] | 2-14 | Reclining Seatbacks | 1-3 |
| Periodic Maintenance Inspections | 7-44 | | |

| | | | |
|---------------------------------------|------|---|------------------|
| Recovery Tank, Coolant | 5-17 | Incorrect Usage | 1-13, 1-29, 1-30 |
| Remote Hatch Release | 2-9 | Lap Belt Cinch Feature | 1-12 |
| Replacement Bulbs | 6-73 | Lap-Shoulder | 1-11 |
| Replacement Parts | 6-75 | Larger Children | 1-29 |
| Replacement, Wheel | 6-53 | Passenger Position | 1-23 |
| Reporting Safety Defects | 8-9 | Questions and Answers | 1-10 |
| Restraints | | Reminder Light | 1-6, 2-75 |
| Checking | 1-31 | Replacing After a Crash | 1-32 |
| Child | 1-26 | Smaller Children and Babies | 1-24 |
| Replacing Parts After a Crash | 1-32 | Use During Pregnancy | 1-23 |
| System Check | 7-41 | Why They Work | 1-7 |
| Reverse, Automatic Transmission | 2-22 | Safety Defects, Reporting | 8-9 |
| Reverse, Manual Transmission | 2-24 | Safety Warnings and Symbols | viii |
| Ride Control | 2-27 | Scheduled Maintenance Services | 7-3 |
| Ride Control Fuse | 6-72 | Seatback | |
| Roadside Assistance | 8-4 | Latches | 1-5 |
| Roadside Assistance, Canadian | 8-6 | Reclining | 1-3 |
| Rocking Your Vehicle | 5-40 | Seats | 1-1 |
| Roof Panel | 2-53 | Manual Front | 1-1 |
| Rotation, Tire | 6-49 | Power | 1-2 |
| S afety Belts | 1-6 | Securing a Child Restraint | 1-26 |
| Adults | 1-11 | Sport | 1-3 |
| Care | 6-56 | Seats and Restraint Systems | 1-1 |
| Children | 1-24 | Seats and Seat Controls | 1-1 |
| Driver Position | 1-11 | Second Gear, Automatic Transmission | 2-23 |
| Extender | 1-31 | Second Gear, Manual Transmission | 2-24 |
| How to Wear Properly | 1-11 | Security Light | 2-93 |
| | | Security Shade | 2-48 |

| | | | |
|--|------------|---|----------|
| Service | 6-1 | Stains, Cleaning | 6-54 |
| ASR Light | 2-80, 4-9 | Starter Switch Check | 7-42 |
| Bulletins, Ordering | 8-11 | Starting Your Engine | 2-18 |
| Engine Soon Light | 2-86 | Steam | 5-13 |
| LTPWS Light | 2-85 | Steering | 4-10 |
| Manuals, Ordering | 8-11 | Column Lock Check | 7-43 |
| Parts Identification Label | 6-63 | in Emergencies | 4-11 |
| Publications, Ordering | 8-10 | Power | 4-10 |
| Ride Control Light | 2-92 | Tips | 4-10 |
| Work, Doing Your Own | 6-2 | Wheel, Tilt | 2-35 |
| Service and Appearance Care | 6-1 | Storage Compartments | 2-47 |
| Service and Owner Publications | 8-10 | Storage, Vehicle | 6-35 |
| Servicing Your Air Bag-Equipped Corvette | 1-22 | Stuck, If You Are | 5-39 |
| Shift Speeds | 2-25 | Stuck: In Sand, Mud, Ice or Snow | 5-39 |
| Shifting | 2-21, 2-24 | Sun Visors | 2-51 |
| Into Park | 2-29 | Symbols, Vehicle | x |
| Out of Park | 2-31 | System Controls, Climate Control System | 3-1, 3-4 |
| Sidemarkers Lamp Bulb Replacement | 6-39 | System Problems Light | 2-93 |
| Signaling Turns | 2-36 | | |
| Sixth Gear, Manual Transmission | 2-24 | T achometer | 2-74 |
| Skidding | 4-14 | Taillamp Bulb Replacement | 6-42 |
| Sound Equipment, Adding | 3-18 | Tape Player Care | 3-19 |
| Spare Tire, Compact | 5-38 | Temperature Control | 3-1, 3-4 |
| Speaker Covers, Cleaning | 6-56 | Theft | 2-12 |
| Specifications and Capacities | 6-74 | Theft-Deterrent Alarm System | 2-13 |
| Specifications, Engine | 6-74 | Thermostat | 6-29 |
| Speech Impaired, Customer Assistance | 8-3 | Third Gear, Manual Transmission | 2-24 |
| Speedometer | 2-74 | Tilt Steering Wheel | 2-35 |
| Sport Seat | 1-3 | Time, Setting the | 3-10 |
| Springs, Fiberglass | 6-61 | | |

| | |
|--------------------------------|------------|
| Tire Chains | 6-53 |
| Tire-Loading Information Label | 4-28 |
| Tires | 6-46 |
| Alignment and Balance | 6-52 |
| Buying New | 6-50 |
| Changing a Flat | 5-22 |
| Cleaning | 6-60 |
| Compact Spare | 5-38 |
| Extended Mobility | 6-47 |
| Inflation | 6-48 |
| Inflation Check | 7-40 |
| Inspection and Rotation | 6-49 |
| Loading | 4-28 |
| Pressure | 6-48 |
| Storing a Flat | 5-33, 5-36 |
| Temperature | 6-51 |
| Traction | 6-51 |
| Treadwear | 6-51 |
| Uniform Quality Grading | 6-51 |
| Wear Indicators | 6-49 |
| Wheel Replacement | 6-52 |
| When It's Time for New | 6-49 |
| Top Strap | 1-26 |
| Torque Lock | 2-31 |
| Torque, Wheel Nut | 5-32, 6-75 |
| Towing a Trailer | 4-29 |
| Towing Your Vehicle | 5-6 |
| Trailer Towing | 4-29 |

| | |
|---------------------------------------|------|
| Transmission Fluid | 6-18 |
| Automatic | 6-18 |
| Manual | 6-21 |
| Transmitters, Passive Keyless Entry | 2-4 |
| Transportation, Courtesy | 8-6 |
| Trip Odometer | 2-74 |
| TTY Users | 8-3 |
| Turn Signal and Lane Change Indicator | 2-36 |
| Turn Signal/Multifunction Lever | 2-35 |

| | |
|------------------------------------|------|
| U nderbody Flushing Service | 7-43 |
| Underbody Maintenance | 6-61 |
| Underhood Lamps Fuse | 6-72 |
| Universal Theft-Deterrent | 2-13 |

| | |
|-----------------------|------|
| V ehicle | |
| Control | 4-5 |
| Damage Warnings | ix |
| Dimensions | 6-77 |
| Identification Number | 6-63 |
| Loading | 4-28 |
| Storage | 6-35 |
| Ventilation System | 3-9 |
| Visor Vanity Mirrors | 2-51 |
| Visors, Sun | 2-51 |
| Voltmeter | 2-77 |

| | | | |
|---|------------|-------------------------|------------|
| Warning Devices | 5-2 | Windows | 2-34 |
| Warning Lights, Gauges and Indicators | 2-74 | Express-Down | 2-34 |
| Washer Fluid, Windshield | 6-30 | Power | 2-34 |
| Washing Your Vehicle | 6-58 | Windshield Washer | 2-38 |
| Weatherstrips | 6-57 | Fluid | 6-30 |
| Wheel | | Fluid Level Check | 7-40 |
| Alignment | 6-52 | Windshield Wipers | 2-37 |
| Lock Key | 5-24 | Blade Replacement | 6-45, 6-75 |
| Nut Torque | 5-32, 6-75 | Fuses | 6-64 |
| Replacement | 6-52 | Winter Driving | 4-24 |
| Wrench | 5-23 | Wiring, Headlamp | 6-64 |
| | | Wrecker Towing | 5-6 |

