



RAM TRUCK

USER GUIDE **2010**



IMPORTANT: This User Guide is intended to familiarize you with the important features of your vehicle. The DVD enclosed contains your Owner's Manual, Navigation Radio or Multimedia Radio Manual, Warranty Booklets, Tire Warranty and 24-Hour Towing Assistance (new vehicles purchased in the U.S.) or Roadside Assistance (new vehicles purchased in Canada) in electronic format. We hope you find it useful. If you are the first registered owner of your vehicle, you may obtain a printed copy of the Owner's Manual, Navigation Radio or Multimedia Radio Manual or Warranty Booklet by calling [1-800-992-1997 \(U.S.\)](tel:1-800-992-1997) or [1-800-387-1143 \(Canada\)](tel:1-800-387-1143) or by contacting your dealer. Replacement manuals may be purchased by visiting www.techauthority.com.
Copyright © 2009 Chrysler Group LLC.

TABLE OF CONTENTS

INTRODUCTION/WELCOME

WELCOME FROM CHRYSLER GROUP LLC . . . 2

CONTROLS AT A GLANCE

DRIVER COCKPIT 4
INSTRUMENT CLUSTER 6

GETTING STARTED

KEY FOB 8
THEFT ALARM 9
SEAT BELT 9
FRONT SEATS 9
REAR HEATED SEATS 12
HEATED STEERING WHEEL 13
TILT STEERING COLUMN / ADJUSTABLE
PEDALS 13
POWER SLIDING REAR WINDOW 14
DIESEL ENGINE STARTING PROCEDURES . 14
PROGRAMMABLE FEATURES 15

OPERATING YOUR VEHICLE

TURN SIGNALS/WIPER/WASHER/HIGH
BEAMS LEVER 17
HEADLIGHT SWITCH 18
SPEED CONTROL LEVER 18
MANUAL CLIMATE CONTROLS 20
AUTOMATIC TEMPERATURE CONTROL
(ATC) 20
PARKSENSE® REAR PARK ASSIST 21
PARKVIEW® REAR BACK-UP CAMERA . . . 21
DIESEL EXHAUST BRAKE (ENGINE
BRAKING) 21
IDLE-UP FEATURE (DIESEL/AUTOMATIC
TRANSMISSION ONLY) 22
POWER SUNROOF 22
WIND BUFFETING 23

ELECTRONICS

NON-TOUCH-SCREEN RADIOS 24
TOUCH-SCREEN RADIOS 26
REMOTE AUDIO CONTROLS 29
VIDEO ENTERTAINMENT SYSTEM
(VES)™ 30
UNIVERSAL CONSUMER INTERFACE 31
ELECTRONIC VEHICLE INFORMATION
CENTER (EVIC) 32
UNIVERSAL GARAGE DOOR OPENER . . . 32
POWER INVERTER 33
POWER OUTLET 34
uconnect™ phone 34
VOICE RECOGNITION 36

OFF-ROAD CAPABILITIES

FOUR-WHEEL DRIVE OPERATION 37

UTILITY

EASY-OFF TAILGATE 38
RAMBOX® 39
TRAILER TOWING WEIGHTS (MAXIMUM
TRAILER WEIGHT RATINGS) 42
RECREATIONAL TOWING (BEHIND
MOTORHOME, ETC.) 42
BRAKE/TRANSMISSION INTERLOCK
MANUAL OVERRIDE 43

WHAT TO DO IN EMERGENCIES

24 HOUR TOWING ASSISTANCE 44
INSTRUMENT CLUSTER WARNING
LIGHTS 44
IF YOUR ENGINE OVERHEATS 47
JACKING AND TIRE CHANGING 48
JUMP-STARTING 54
EMERGENCY TOW HOOKS 56
TOWING A DISABLED VEHICLE 57
FREEING A STUCK VEHICLE 58
EVENT DATA RECORDER (EDR) 58

MAINTAINING YOUR VEHICLE

OPENING THE HOOD 59
ENGINE COMPARTMENT 60
FUEL FILTER / WATER SEPARATOR
— DIESEL ONLY 64
EXHAUST REGENERATION
— DIESEL ONLY 65
FLUIDS AND CAPACITIES 66
MAINTENANCE CHART 70
FUSES 74
TIRE PRESSURES 78
WHEEL AND WHEEL TRIM CARE 78
EXTERIOR BULBS 79

CONSUMER ASSISTANCE

CHRYSLER GROUP LLC CUSTOMER
CENTER 80
CHRYSLER CANADA INC. CUSTOMER
CENTER 80
ASSISTANCE FOR THE HEARING
IMPAIRED 80
PUBLICATIONS ORDERING 80
REPORTING SAFETY DEFECTS IN THE
50 UNITED STATES AND
WASHINGTON, D.C. 81
TIRE WARRANTY 81

MOPAR ACCESSORIES

MOPAR® ACCESSORIES 84

INTRODUCTION/WELCOME

WELCOME FROM CHRYSLER GROUP LLC

Congratulations on selecting your new Chrysler Group LLC vehicle. Be assured that it represents precision workmanship, distinctive styling, and high quality - all essentials that are traditional to our vehicles.

IMPORTANT: This User Guide is intended to familiarize you with the important features of your vehicle. The DVD enclosed contains your Owner's Manual, Warranty Booklets, Tire Warranty, and 24 Hour Towing Assistance (new vehicles purchased in the U.S.) or Roadside Assistance (new vehicles purchased in Canada) in electronic format. We hope you find it useful. Retail customers may obtain a printed copy of any of these booklets, call 1-800-890-4038 (U.S.) or 1-800-387-1143 (Canada) or ask your dealer.

For complete owner information, refer to the DVD in the owner's kit provided at the time of new vehicle purchase. For your convenience, the information contained on the DVD may also be printed and saved for future reference.

Not all features shown in this guide may apply to your vehicle.

Chrysler Group LLC is committed to protecting our environment and natural resources. By converting from paper to electronic delivery for the majority of the user information for your vehicle, together we greatly reduce the demand for tree-based products and lessen the stress on our environment.

Vehicles Sold In Canada

With respect to any Vehicles Sold in Canada, the name Chrysler Group LLC shall be deemed to be deleted and the name Chrysler Canada Inc. used in substitution therefore.

Driving And Alcohol

Drunken driving is one of the most frequent causes of accidents.

Your driving ability can be seriously impaired with blood alcohol levels far below the legal minimum. If you are drinking, don't drive. Ride with a designated non-drinking driver, call a cab, a friend, or use public transportation.

WARNING!

Driving after drinking can lead to an accident. Your perceptions are less sharp, your reflexes are slower, and your judgment is impaired when you have been drinking. Never drink and then drive.

This guide illustrates and describes the operation of features and equipment that are either standard or optional on this vehicle. This guide may also include a description of features and equipment that are no longer available or were not ordered on this vehicle. Please disregard any features and equipment described in this guide that are not available on this vehicle. Chrysler Group LLC reserves the right to make changes in design and specifications and/or make additions to or improvements to its products without imposing any obligation upon itself to install them on products previously manufactured.

INTRODUCTION/WELCOME

CAUTION!

Never park your vehicle over dry grass or other combustible materials. The heat from your vehicle exhaust system could cause a fire.

CHRYSLER, DODGE, JEEP, ATF+4, MOPAR and uconnect are registered trademarks of Chrysler Group LLC.

COPYRIGHT ©2009 CHRYSLER GROUP LLC



CONTROLS AT A GLANCE

DRIVER COCKPIT



CONTROLS AT A GLANCE

















CONTROLS AT A GLANCE



INSTRUMENT CLUSTER













Warning Lights

-  - Low Fuel Warning Light
-  - Charging System Light**
-  - Oil Pressure Warning Light**
-  - Anti-Lock Brake (ABS) Light**
-  - Airbag Warning Light**
-  - Electronic Throttle Control (ETC) Light
-  - Tire Pressure Monitoring System (TPMS) Light
-  - Engine Temperature Warning Light
-  - Transmission Temperature Warning Light
-  - Seat Belt Reminder Light
- BRAKE**  - Brake Warning Light**
-  - Malfunction Indicator Light (MIL)**
- ESP BAS**  - Electronic Stability Program (ESP) Indicator Light/Brake Assist System (BAS) Warning Light
- SERV 4WD**  - SERV (Service) 4WD Indicator Light

CONTROLS AT A GLANCE



Indicators



- | | | | |
|---|---|---|--|
|  | - Turn Signal Indicators |  | - Electronic Stability Program (ESP)/Traction Control System (TCS) Indicator |
|  | - High Beam Indicator |  | - Cargo Lamp On Indicator |
|  | - Front Fog Light Indicator |  | - Exhaust Brake Indicator (Diesel Only) |
|  | - Vehicle Security Indicator* |  | - Door Ajar Indicator |
|  | - TOW/HAUL Indicator |  | - Electronic Speed Control On Indicator |
|  | - Four-Wheel Drive and 4LOCK Mode Indicator |  | - Loose Gas Cap Indicator |
|  | - 4WD Auto Indicator | | |

Odometer Messages

ECO - Fuel Saver Indicator
 door - Door Ajar
 gASCAP - Fuel Cap Fault
 Lo tire - Low Tire Pressure

* If equipped

** Bulb Check with Key On

LoWASH - Low Washer Fluid
 noFUSE* - Fuse Fault
 CHAngE OIL* - Change Engine Oil
 Water in Fuel -  (Diesel Only)
 Wait to Start -  (Diesel Only)

GETTING STARTED

KEY FOB



Locking And Unlocking The Doors

- Press the LOCK button once to lock all the doors. Press the UNLOCK button once to unlock the driver's door only and twice within five seconds to unlock all the doors.
- All doors can be programmed to unlock on the first press of the UNLOCK button.

WARNING!

Leaving unattended children in a vehicle is dangerous for a number of reasons. A child or others could be injured. Children should be warned not to touch the parking brake, brake pedal, or the shift lever. Do not leave the key in the ignition. A child could operate power windows, other controls, or move the vehicle.

Remote Start

- Press the REMOTE START button  twice within five seconds. Pressing the REMOTE START button a third time shuts the engine off.
- To drive the vehicle, press the UNLOCK button, insert the Key Fob in the ignition and turn to the ON/RUN position.
- With remote start, the engine will only run for 15 minutes (timeout) unless the ignition Key Fob is placed in the ON/RUN position.
- The vehicle must be started with the Key Fob after two consecutive timeouts.

WARNING!

- Do not start or run an engine in a closed garage or confined area. Exhaust gas contains Carbon Monoxide (CO) which is odorless and colorless. Carbon Monoxide is poisonous and can cause serious injury or death when inhaled.
- Keep Remote Keyless Entry (RKE) transmitters away from children. Operation of the Remote Start System, windows, door locks or other controls could cause serious injury or death.

Panic Alarm

- Press the PANIC button once to turn the panic alarm on.
- Wait approximately three seconds and press the button a second time to turn the panic alarm off.

GETTING STARTED

Express Window Feature

- To remotely lower both front door windows at the same time, press and release the UNLOCK button and then immediately press and hold the UNLOCK button until the windows lower to the level desired or until they lower completely.

Emergency Key

- Should the battery in the vehicle or the Key Fob transmitter go dead, there is an emergency key located in the Key Fob. To remove the emergency key, slide the button at the top of the Key Fob sideways with your thumb and then pull the key out with your other hand.

THEFT ALARM

To Arm

- Press the Key Fob LOCK button or the power door lock switch while the door is open.

To Disarm

- Press the Key Fob UNLOCK button or turn the ignition to the ON position.

SEAT BELT

- Be sure everyone in your vehicle is in a seat using a seat belt properly.

WARNING!

In a collision, you and your passengers can suffer much greater injuries if you are not properly buckled up. You can strike the interior of your vehicle or other passengers, or you can be thrown out of the vehicle. Always be sure you and others in your vehicle are buckled up properly.

FRONT SEATS

WARNING!

Adjusting a seat while the vehicle is moving is dangerous. The sudden movement of the seat could cause you to lose control. The seat belt might not be properly adjusted and you could be injured. Only adjust a seat while the vehicle is parked.

GETTING STARTED

Manual Seat Adjustment

Forward/Rearward



- Lift up on the adjusting bar located at the front of the seat near the floor and release at the desired position.

Recliner



- Lift the recliner lever located on the outboard side of the seat, lean back and release at the desired position.

WARNING!

- Actuating the recliner handle will allow the seatback to swing (dump) forward on manual recliner seats. Do not stand or lean in front of the seat while actuating the handle. The seatback may swing forward and hit you causing injury. This dump feature allows access to the storage bin behind the seat. To avoid injury, place your hand on the seatback and actuate the handle, then position the seatback in the desired position.
- Do not ride with the seatback reclined so that the seat belt is no longer resting against your chest. In a collision, you could slide under the seat belt and be seriously or even fatally injured. Use the recliner only when the vehicle is parked.

GETTING STARTED

Eight-Way Driver Power Seat

- The seat switch controls forward/backward and up/down.
- The seatback switch controls the angle of the seatback. Push switch forward or rearward and the seatback will move in either direction.

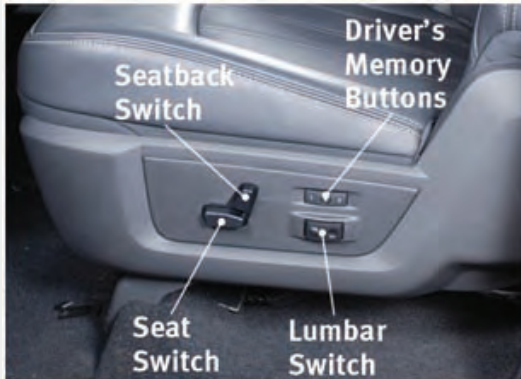

Power Lumbar

- The lumbar controls are located on the outboard side of the seat cushion. The lumbar support can be increased by pressing the front of the switch and decreased by pressing the back of the switch.

Memory Seats

- The memory seat feature allows you to save the driver's seat position, driver's outside mirror position, adjustable brake and accelerator pedals, Automatic Temperature Control (ATC) temperature setting and radio station preset settings. The driver's memory buttons are located on the outboard side of the driver's seat cushion.
- Adjust all memory profile settings, press the SET button, then press 1 or 2 within five seconds.
- To program a Key Fob to the memory position, place the ignition switch in the OFF position and press and release the LOCK button within 10 seconds on the Key Fob to be programmed.
- Press 1 or 2 to recall the saved positions, or press UNLOCK on the programmed Key Fob.
- Refer to the Owner's Manual on the DVD for further details.

Front Heated Seats

- The controls for front heated seats are located on the center instrument panel below the climate controls.
- Press the switch once to select High-level heating. Press the switch a second time to select Low-level heating. Press the switch a third time to shut the heating elements Off.

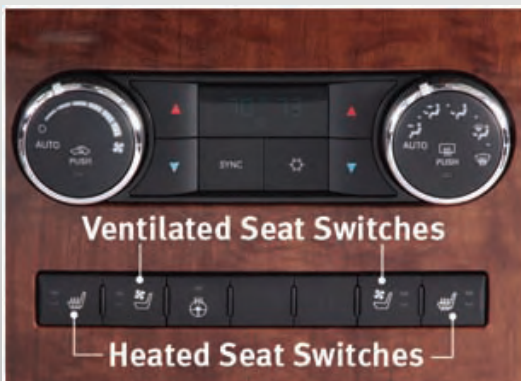

GETTING STARTED

WARNING!

- Persons who are unable to feel pain to the skin because of advanced age, chronic illness, diabetes, spinal cord injury, medication, alcohol use, exhaustion or other physical condition must exercise care when using the seat heater. It may cause burns even at low temperatures, especially if used for long periods of time.
- Do not place anything on the seat that insulates against heat, such as a blanket or cushion. This may cause the seat heater to overheat. Sitting in a seat that has been overheated could cause serious burns due to the increased surface temperature of the seat.

CAUTION!

Repeated overheating of the seat could damage the heating element and/or degrade the material of the seat.

Ventilated Seats

- Small fans that draw the air from around the occupant and exhaust it underneath the seat and into the passenger compartment are located in the seat cushion and seatback. The fans draw this air across the surface of the seat using air ducts and fine perforations in the covering to help keep the driver cooler in higher ambient temperatures.
- The ventilated seat switches are located in the center instrument panel below the climate controls. Press the switch once to select High speed. Press the switch a second time to select Low speed.

REAR HEATED SEATS

- Second row heated seat switches are located on the rear of the center console.
- Press the switch once to select High-level heating. Press the switch a second time to select Low-level heating. Press the switch a third time to shut the heating elements Off.

WARNING!

- Persons who are unable to feel pain to the skin because of advanced age, chronic illness, diabetes, spinal cord injury, medication, alcohol use, exhaustion or other physical condition must exercise care when using the seat heater. It may cause burns even at low temperatures, especially if used for long periods of time.
- Do not place anything on the seat that insulates against heat, such as a blanket or cushion. This may cause the seat heater to overheat. Sitting in a seat that has been overheated could cause serious burns due to the increased surface temperature of the seat.

CAUTION!

Repeated overheating of the seat could damage the heating element and/or degrade the material of the seat.

GETTING STARTED

HEATED STEERING WHEEL



- The steering wheel contains a heating element that heats the steering wheel to one temperature setting.
- The heated steering wheel switch is located on the center instrument panel below the climate controls.
- Once the heated steering wheel has been turned on, it will operate for approximately 58 to 70 minutes before automatically shutting off. The heated steering wheel can shut off early or may not turn on when the steering wheel is already warm.

TILT STEERING COLUMN / ADJUSTABLE PEDALS

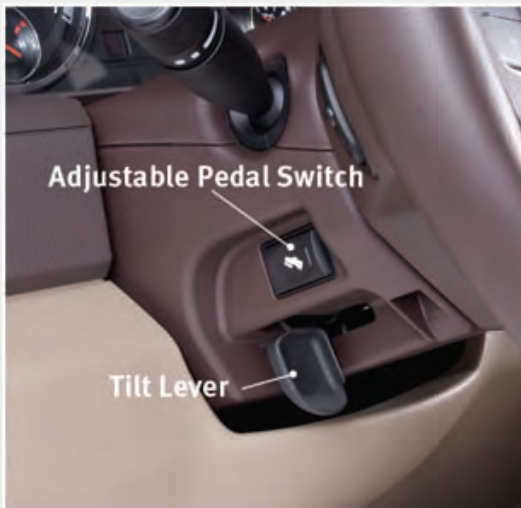

Tilt Steering Column

- The tilt lever is located on the steering column, below the turn signal lever.
- Pull forward on the lever and move the steering wheel up or down as desired.
- Release the lever to lock the steering wheel into position.

Adjustable Pedals

- Press the switch located on the left side of the steering column forward to move the brake and accelerator pedals away from the driver and press the button rearward to move the pedals closer to the driver.

NOTE: The pedals cannot be adjusted when the vehicle is in REVERSE or when the Electronic Speed Control is set.

WARNING!

Tilting the steering column while the vehicle is moving is dangerous. Without a stable steering column, you could lose control of the vehicle and have an accident. Adjust the column only while the vehicle is stopped. Be sure it is locked before driving.

WARNING!

Do not adjust the pedals while the vehicle is moving. You could lose control and have an accident. Always adjust the pedals while the vehicle is parked.

GETTING STARTED

CAUTION!

Do not place any article under the adjustable pedals or impede its ability to move, as it may cause damage to the pedal controls. Pedal travel may become limited if movement is stopped by an obstruction in the adjustable pedal's path.

POWER SLIDING REAR WINDOW



- The switch for the power sliding rear window is located on the overhead console.
- Press the left side of the switch to open the glass and the right side of the switch to close the glass.

DIESEL ENGINE STARTING PROCEDURES

Engine Block Heater

- For ambient temperatures below 0°F (-18°C), engine block heater usage is recommended.
- For ambient temperatures below -20°F (-29°C), engine block heater usage is required.
- The engine block heater cord is routed under the hood to the right side and can be located just behind the grille near the headlamp.
- Connect the heater cord to a ground-fault interrupter protected 110–115 volt AC electrical outlet with a grounded, three-wire extension cord.

NOTE: The block heater will require 110 volts AC and 6.5 amps to activate the heater element.

- The block heater must be plugged in at least one hour to have an adequate warming effect on the coolant.

WARNING!

Remember to disconnect the cord before driving. Damage to the 110–115 volt electrical cord could cause electrocution.

Water In Fuel Message

- If a Water In Fuel message or  indicator appears in the cluster and a chime sounds five times, the fuel/water separator will need to be drained immediately to prevent engine damage.
- Refer to Maintaining Your Vehicle in this guide for draining instructions or see your dealer.



GETTING STARTED

Cold Start Procedure

- Turn the ignition switch to the ON position. If the Wait To Start  light appears in the cluster, wait for the light to turn off before starting.
- In extremely cold conditions, when the engine temperature may be below 0°F (-18°C), cycle the manifold heaters twice with a five-second pause between cycles.
- Refer to the Owner's Manual Diesel Supplement on the DVD for further details.

PROGRAMMABLE FEATURES

Electronic Vehicle Information Center (EVIC) – If Equipped

- The EVIC can be used to program the following Personal Settings. Press the UP  or DOWN  button until SETUP displays, then press the SELECT button . Scroll through the settings using the UP or DOWN button. Press the SELECT button to change the setting.

- Language
- Auto Door Locks
- Auto Unlock Doors
- 1st Press RKE
- RKE Linked To Memory
- Horn With Remote Lock
- Flash Lamp Lock
- Turn Headlamps On With Wipers
- Headlamp Off Delay
- Easy Exit Seat
- Automatic High Beams
- Wiper Mode
- Tilt MIRR. In Reverse
- Key-Off Power Delay
- ILLUMIN. Approach
- Horn With Remote Start
- Display Units of Measure In
- Hill Start Assist
- NAV–Turn By Turn
- Display Fuel Saver
- Remote Start Comfort Sys.
- Calibrate Compass
- Compass Variance
- Enable/Disable the Rear Park Assist System

Key Fob Programmable Features

- The following features may also be programmed by using the Key Fob transmitter or the ignition switch and driver's door lock switch.

NOTE: Pressing the LOCK button while you are inside the vehicle will activate the Vehicle Security Alarm. Opening a door with the Vehicle Security Alarm activated will cause the alarm to sound. Press the UNLOCK button to deactivate the Vehicle Security Alarm.

Unlock On First Press

- To unlock either the driver's side, or all doors, on the first press of the UNLOCK button:
 - Press and hold the LOCK button for at least 4 seconds, but no longer than 10 seconds. Then, press and hold the UNLOCK button while still holding the LOCK button.
 - Release both buttons at the same time.

GETTING STARTED

Auto Unlock Doors On Exit

- To have all of the vehicle doors unlock when any door is opened:
 - Enter your vehicle, close all the doors and fasten your seat belt.
 - Within 15 seconds, cycle the ignition switch from the OFF position to the ON position a minimum of four times ending in the OFF position (do not start the engine).
 - Within 30 seconds, press the driver's door lock switch in the UNLOCK direction. A single chime will indicate that programming is complete.

Auto Door Lock

- To have the doors lock automatically when the vehicle's speed exceeds 15 mph (24 km/h):
 - Enter your vehicle, close all the doors and fasten your seat belt.
 - Within 15 seconds, cycle the ignition switch from the OFF position to the ON position a minimum of four times ending in the OFF position (do not start the engine).
 - Within 30 seconds, press the driver's door lock switch in the LOCK direction. A single chime will indicate that programming is complete.

Sound Horn With Lock

- To turn the horn chirp on or off when the doors are locked:
 - Press the LOCK button for at least 4 seconds, but no longer than 10 seconds. Then, press the PANIC button while still holding the LOCK button.
 - Release both buttons at the same time.

Flashing Lights With Lock

- The turn signal lights flashing, when the doors are locked or unlocked, feature can be turned on or off. To turn this feature on or off:
 - Press and hold the UNLOCK button for at least 4 seconds, but no longer than 10 seconds. Then, press and hold the LOCK button while still holding the UNLOCK button.
 - Release both buttons at the same time.

OPERATING YOUR VEHICLE

TURN SIGNALS/WIPER/WASHER/HIGH BEAMS LEVER



Turn Signals/Lane Change Assist

- Tap the lever up or down once and the turn signal (right or left) will flash three times then automatically turn off.

Wipers

Intermittent, Low And High Operation

- Rotate the end of the lever to the first detent position for one of five intermittent settings, the second detent for low wiper operation and the third detent for high wiper operation.

Washer Operation

- Push the end of the lever inward to the second detent and hold for as long as spray is desired.

High Beams

- Push the lever away from you to activate the high beams.
- A high beam symbol will illuminate in the cluster to indicate the high beams are on.



NOTE: For safe driving, turn off high beams when oncoming traffic is present to prevent headlight glare and as a courtesy to other motorists.

OPERATING YOUR VEHICLE

HEADLIGHT SWITCH



Automatic Headlights/Parking Lights/Headlights

- Rotate the headlight switch to the first detent for parking lights  and to the second detent for headlights .
- Rotate the headlight switch to "A" for AUTO headlights.
- When set to "A" (AUTO), the system automatically turns the headlights on or off based on ambient light levels.

Instrument Panel Dimmer

- Rotate the dimmer control to the extreme left position to fully dim the instrument panel lights and prevent the interior lights from illuminating when a door is opened.
- Rotate the dimmer control right to increase the brightness of the instrument panel when the parking lights or headlights are on.
- Rotate the dimmer control right to the next detent position to fully brighten the odometer and radio when the parking lights or headlights are on. Refer to your Multimedia or Navigation User Manual on the DVD for display dimming.
- Rotate the dimmer control right to the last detent position to turn on the interior lighting.

Cargo Light

- The cargo light is strategically placed lighting that helps illuminate the bed area of the truck. A cargo light symbol will illuminate in the cluster to indicate the light is on.
- Push the button to turn ON/OFF the cargo lighting.

SPEED CONTROL LEVER



Cruise ON/OFF

- Push the ON/OFF button to activate the Speed Control.
- CRUISE will appear on the instrument cluster to indicate the Speed Control is on.
- Push the ON/OFF button a second time to turn the system off.

OPERATING YOUR VEHICLE

WARNING!

Leaving the Electronic Speed Control system on when not in use is dangerous. You could accidentally set the system or cause it to go faster than you want. You could lose control and have an accident. Always leave the Electronic Speed Control system off when you are not using it.

Set

- With Speed Control on, push down and release the lever to set a desired speed.

WARNING!

Electronic Speed Control can be dangerous where the system cannot maintain a constant speed. Your vehicle could go too fast for the conditions, and you could lose control. An accident could be the result. Do not use Electronic Speed Control in heavy traffic or on roads that are winding, icy, snow-covered or slippery.

Accel/Decel

- Push and hold the lever up to accelerate or down to decelerate the vehicle; release the lever to save the new set speed.
- Once a speed is set, tapping the lever up or down will increase or decrease the set speed approximately 1 mph (2 km/h).

Cancel

- Pull the lever toward you, push the clutch pedal or apply the brakes to cancel the set speed and maintain the set speed in memory.
- Push the ON/OFF button to turn the system off and erase the set speed memory.

Resume

- To resume a previously selected speed in memory, push the lever up and release.

OPERATING YOUR VEHICLE

MANUAL CLIMATE CONTROLS



Air Recirculation /Max A/C

- Rotate the Temperature Control to the MAX A/C position to automatically turn on both Air Conditioning and Recirculation.
- For window defogging, turn the recirculation button off.
- Recirculation is not allowed in defrost, floor, defrost/floor (mix) modes.

AUTOMATIC TEMPERATURE CONTROL (ATC)



- Rotate both the Mode Control and Blower Control to the AUTO position.
- Select the desired temperature by pushing the up or down temperature buttons for the driver or passenger.
- The system will maintain the set temperature automatically.

Air Conditioning (A/C)

- If the A/C button is pushed while in the AUTO mode, the indicator light may flash three times to indicate the cabin air is being controlled automatically.

OPERATING YOUR VEHICLE

SYNC Temperature Button

- Push the SYNC button once to control the driver and passenger temperatures simultaneously. Push the SYNC button a second time to control the temperatures individually.

Air Recirculation

- Use recirculation for maximum A/C operation.
- For window defogging turn the recirculation button off.
- If the recirculation button is pushed while in the AUTO mode, the indicator light may flash three times to indicate the cabin air is being controlled automatically.

PARKSENSE[®] REAR PARK ASSIST

- If an object is detected behind the rear bumper while the vehicle is in REVERSE, a warning will display in the instrument cluster and a tone, that changes speed depending on the distance of the object from the bumper, will sound.

PARKVIEW[®] REAR BACK-UP CAMERA

- You can see an on-screen image of the rear of your vehicle whenever the shift lever is put into REVERSE. The ParkView[®] Rear Back-Up Camera image will be displayed on the radio display screen, located on the center stack of the instrument panel.

WARNING!

Drivers must be careful when backing up even when using the ParkView[®] Rear Back-Up Camera. Always check carefully behind your vehicle, and be sure to check for pedestrians, animals, other vehicles, obstructions, or blind spots before backing up. You are responsible for the safety of your surroundings and must continue to pay attention while backing up. Failure to do so can result in serious injury or death.

DIESEL EXHAUST BRAKE (ENGINE BRAKING)

- The exhaust brake feature will only function when the driver turns the exhaust brake switch to the ON position.
- The switch is located on the switch bank below the audio system.
- Once the switch is in the ON position and the vehicle is moving faster than 5 mph (8 km/h); the exhaust brake will automatically operate when the driver removes pressure from the accelerator pedal.
- Exhaust braking is most effective when the engine RPM is higher.

CAUTION!

Use of aftermarket exhaust brakes is not recommended and could lead to engine damage

OPERATING YOUR VEHICLE

WARNING!

Do not use the exhaust brake feature when driving in icy or slippery conditions as the increased engine braking can cause the rear wheels to slide and the vehicle to swing around with the possible loss of vehicle control, which may cause an accident possibly resulting in personal injury or death.

NOTE: For optimum braking power, it is recommended to use the exhaust brake while in TOW/HAUL mode.

IDLE-UP FEATURE (DIESEL/AUTOMATIC TRANSMISSION ONLY)

- The Idle-Up Feature uses the speed control switches to increase engine idle speed and quickly warm the vehicle's interior. This feature must be enabled by your dealer. See your local Dodge dealer.
- With the transmission in PARK, the parking brake applied, and the engine running, push the speed control ON/OFF switch on, then push the SET switch.
- The engine RPM will go up to 1100 RPM. To increase the RPM, push and hold the ACCEL/RESUME switch and the idle speed will increase to approximately 1500 RPM. To decrease the RPM, push and hold the DECEL switch and the idle speed will decrease to approximately 1100 RPM.
- To cancel the Idle Up Feature, either push the CANCEL switch, push the ON/OFF switch or push the brake pedal.

POWER SUNROOF

- The power sunroof switch is located on the overhead console.

WARNING!

- Never leave children in a vehicle with the key in the ignition switch. Occupants, particularly unattended children, can become entrapped by the power sunroof while operating the power sunroof switch. Such entrapment may result in serious injury or death.
- In an accident, there is a greater risk of being thrown from a vehicle with an open sunroof. You could also be seriously injured or killed. Always fasten your seat belt properly and make sure all passengers are properly secured too.
- Do not allow small children to operate the sunroof. Never allow your fingers, other body parts, or any object to project through the sunroof opening. Injury may result.

Opening Sunroof

Express

- Press the switch rearward and release. The sunroof will fully open and stop automatically.

Closing Sunroof

Express

- Press the switch forward and release. The sunroof will close automatically from any position.

OPERATING YOUR VEHICLE

Manual Open/Close

- Press and hold the switch rearward to open or forward to close the sunroof. Any release of the switch will stop the movement, and the sunroof will remain in a partially open or closed position until the switch is pressed again.

Venting Sunroof

- Press and release the "VENT" button, and the sunroof will open to the vent position. This is called "Express Vent" and will occur regardless of sunroof position. During Express Vent operation, any movement of the switch will stop the sunroof.

Pinch Protection Feature

- This feature will detect an obstruction in the opening of the sunroof during Express Close operation. If an obstruction in the path of the sunroof is detected, the sunroof will automatically return to the open position.

NOTE: Pinch protection is disabled while the switch is pressed and held during manual opening and closing of the sunroof.

WIND BUFFETING

- Wind buffeting can be described as a helicopter-type percussion sound. If buffeting occurs with the rear windows open, adjust the front and rear windows together.
- If buffeting occurs with the sunroof open, adjust the sunroof opening, or adjust any window. This will minimize buffeting.

ELECTRONICS

NON-TOUCH-SCREEN RADIOS

RES Radio



RES/RSC Radio



NOTE: uconnect™ phone and Voice Recognition are vehicle options which must be ordered separately. The buttons on the radio will only be active if the vehicle has been equipped with the option.

- The radio sales code is located on the lower right side of the radio faceplate.
- Unless otherwise noted, the information provided on the operation and functionality of the radios in this section is common to all non-touch-screen radios.

Seek Up/Down Buttons

- Press and release to search for and stop at the next listenable station in AM/FM mode.
- Holding either button will bypass stations without stopping.

Audio Settings

- Press the TUNE/SCROLL control knob and BASS, MID, TREBLE, BALANCE and FADE will display. Rotate the TUNE/SCROLL control knob to select the desired setting.

Auxiliary Mode

- The auxiliary (AUX) jack allows a portable device, such as an MP3 player or a cassette player, to be plugged into the radio and utilize the vehicle's audio system and play through the vehicle speakers.

Clock Setting

- Press and hold the TIME button until the hours blink; turn the TUNE/SCROLL control knob to set the hours.
- Press the TUNE/SCROLL control knob until the minutes begin to blink; turn the TUNE/SCROLL control knob to set the minutes.
- Press the TUNE/SCROLL control knob to save the time change.
- To exit, press any button/knob or wait five seconds.

Station Presets

- Press the SET/RND button once and SET 1 will show in the display. Then select the button (1-6).
- A second station may be added to each push button. Press the SET/RND button twice and SET 2 will show in the display, then select button (1-6).

ELECTRONICS

TOUCH-SCREEN RADIOS

Navigation Radio – RER

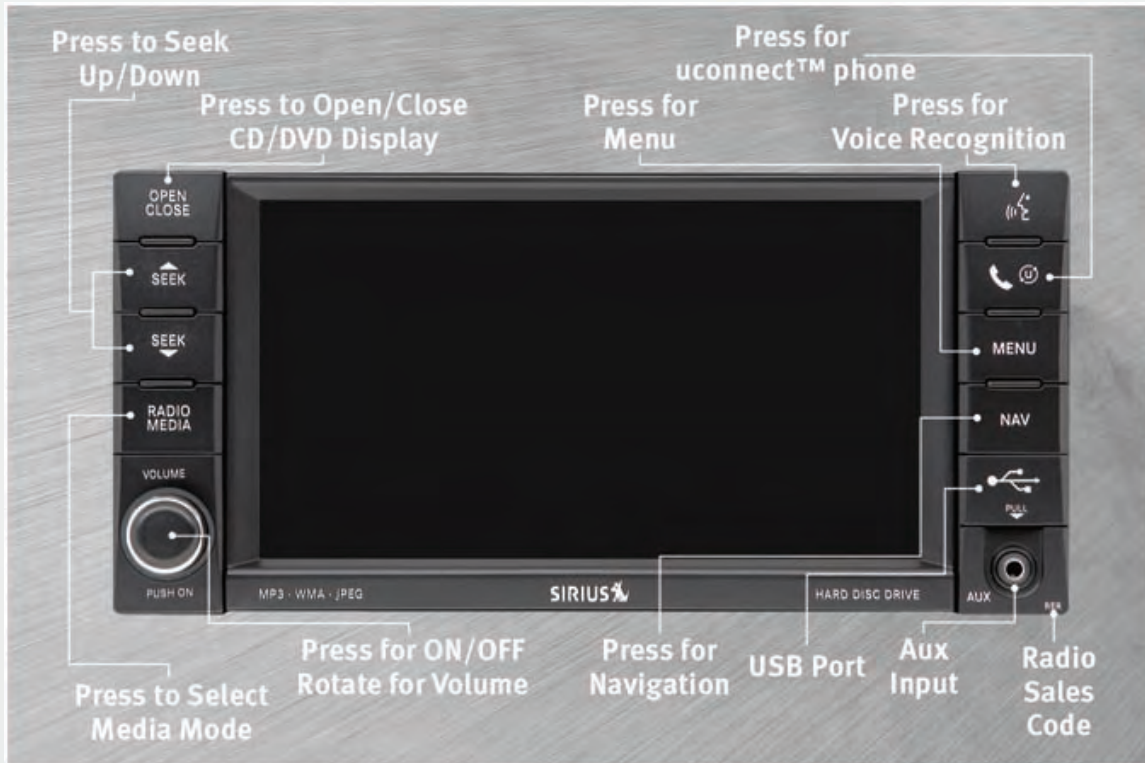

Multimedia Radio – REN

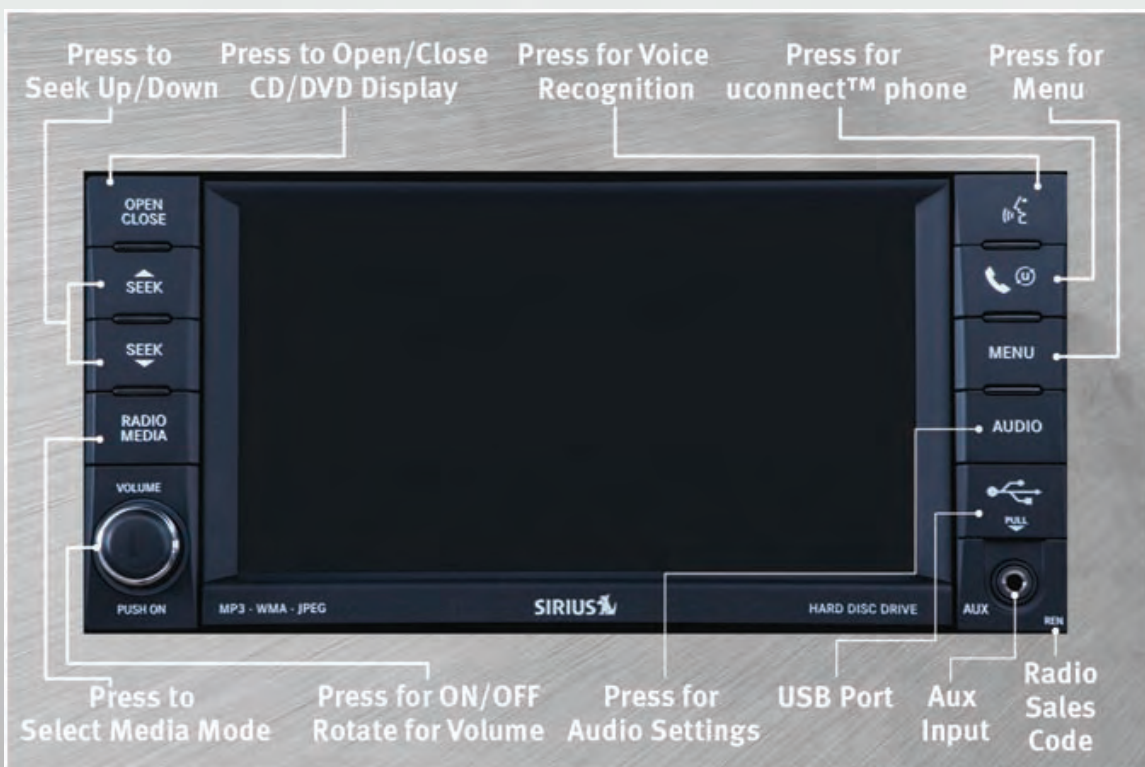

NOTE: uconnect™ phone and Voice Recognition are vehicle options which must be ordered separately. The buttons on the radio will only be active if the vehicle has been equipped with the option.

- The radio sales code is located on the lower right side of the radio faceplate.
- Unless otherwise noted, the information provided on the operation and functionality of the radios in this section is common to all touch-screen radios.

Seek Up/Down

- Press to seek through radio stations in AM, FM, or SAT bands. Seek through tracks in CD or iPod® modes or through songs in the HDD playlist.

Radio Mode

- Press the RADIO/MEDIA hard-key to display the different radio modes, then press the desired soft-key to select AM, FM, SAT, TV, HDD, Disk, Aux or Video Entertainment System (VES)™ modes.

Auxiliary Mode

- The auxiliary (AUX) jack allows a portable device, such as an MP3 player or a cassette player, to be plugged into the radio and utilize the vehicle's audio system and play through the vehicle speakers.

Clock Setting

- Turn the radio on, then touch the screen where the time is displayed.
- Touch the USER CLOCK soft-key (Navigation radio only).
- To adjust the hours, touch either the HOUR FORWARD or HOUR BACKWARD soft-key.
- To adjust the minutes, touch either the MINUTE FORWARD or MINUTE BACKWARD soft-key.
- To save the new time setting, touch the screen where the word "Save" is displayed.

Store Radio Presets

- Press the RADIO/MEDIA hard-key repeatedly until AM FM SAT is displayed in the upper left corner of the screen.
- Select the radio band by touching either the AM, FM, or SAT soft-key.
- Find the station to store by either pressing the SEEK UP/DOWN hard-key, or touching the SCAN soft-key, DIRECT TUNE soft-key or the left and right arrows.
- Once the station is found, touch and hold one of the PRESET soft-keys in the list to the right, until you hear a confirmation beep.

Hard Disc Drive Operation

Copy Complete Audio Disc To Hard-Drive

- Press the OPEN/CLOSE hard-key and insert a disc, then press the MENU hard-key.
- Touch the MY FILES soft-key, then select MY MUSIC.
- Touch the IMPORT MUSIC soft-key, then touch the FROM DISC soft-key in the next screen to start the process.

Copying From USB

- Insert a USB device, then select MY MUSIC.
- Touch the IMPORT MUSIC FILES soft-key, then touch the FROM USB soft-key in the next screen.
- Select the folders or titles you would like to copy, then touch the DONE soft-key to start the copy process.

Copy Pictures To The Hard-Drive

- Insert either a CD or a USB device containing your pictures.
- Touch the MY FILES soft-key, then go to the MANAGE MY FILES screen.
- Touch the MY PICTURES soft-key to get an overview of the currently stored images.
- Touch one of the ADD PICTURES soft-keys, then select the type of media inserted.
- Use the PAGE soft-keys to page through a list of pictures and press the picture you would like to import.
- Confirm your selection by touching the YES soft-key. The imported picture is now available in the MANAGE MY PICTURES screen.
- In order to display the imported picture in the radio screen, touch the desired pictures soft-key.
- Select this picture by pressing the PICTURE VIEW soft-key. A check mark indicates the currently used picture.

Cleaning Your Touch-Screen Radio

- Do not spray any liquid or caustic chemicals directly on the screen. Use a clean and dry micro fiber lens cleaning cloth in order to clean the touch-screen.
- If necessary, use a lint-free cloth dampened with a cleaning solution such as isopropyl alcohol or an isopropyl alcohol and water solution ratio of 50:50. Be sure to follow the solvent manufacture's precautions and directions.

Navigation

Navigation Radio – RER Only

- Navigation radios require digital data from a navigation database. The data in the navigation database is licensed from Navigation Technologies[®]. Not all roads are digitized.
- For software updates, visit <http://www.chrysler.com/en/owners/mygig/> website, visit <http://www.navteq.com> website, or contact your authorized dealer for the latest available software.

NOTE: Many features of this radio are speed dependent. For your own safety, it is not possible to use the touch-screen keyboard to enter a name (e.g., street name) while the vehicle is in motion. Pull over at a safe location to complete your task.

- The Navigation system receives GPS signals from satellites to display the position of your vehicle.

New Destination

- Press the NAV hard-key to access the Navigation Main Menu.
- Touch the NEW DESTINATION soft-key to program a destination, then select the destination soft-key of your choice.

Program/Storing Home Address

- Press the NAV hard-key to access the Navigation Main Menu.
- Touch the GUIDE ME HOME soft-key, then touch the STREET ADDRESS soft-key.
- Touch the STATE soft-key, then enter your state name into the speller; select your state from the list and press the CHANGE soft-key.
- Touch the INPUT STREET NAME soft-key and enter your street name into the speller.
- Touch the CONTINUE soft-key and enter your address into the speller; then touch the CONTINUE soft-key again.
- Touch the city name and touch the SAVE soft-key to complete programming.

Change Stored Home Address

- Press the MENU hard-key, then touch the MY FILES soft-key.
- Touch the MY ADDRESS BOOK soft-key, then touch the HOME soft-key.
- In the Home Address Information screen, touch the EDIT CONTACT soft-key, then touch the CHANGE ADDRESS soft-key in the next screen.
- Touch the INPUT STREET NAME soft-key and enter your street name into the speller.
- Touch the CONTINUE soft-key and enter your address into the speller; touch the CONTINUE soft-key again.
- Touch the city name and touch the SAVE soft-key to complete programming.

Guide Me Home

- Press the NAV hard-key to access the Navigation Main Menu.
- Touch the GUIDE ME HOME soft-key to route you back to your home destination from your current location. Touch the GO soft-key to start your trip.

Map

- Press the NAV hard-key to access the Navigation Main Menu.
- Touch the MAP soft-key to display a map of your current position.

REMOTE AUDIO CONTROLS

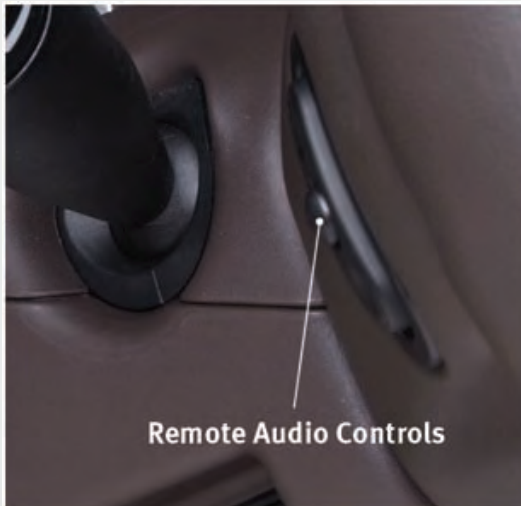

- The switches are located on the rear surface of the steering wheel.

Right Switch

- Press the switch up or down to increase and decrease the volume.
- Press the button in the center to change modes AM/FM/CD/SAT.

Left Switch

- Press the switch up or down to search for the next listenable station or select the next or previous CD track.
- Press the button in the center to select the next preset station (Radio) or to change CDs if equipped with a CD Changer.

ELECTRONICS

VIDEO ENTERTAINMENT SYSTEM (VES)[™]



System Operation

- The screen is located on the headliner behind the front seat. To lower the screen, press the release button located in the center of the console rear of the screen.
- The system may be controlled by the front seat occupants using the touch-screen radio, or by the rear seat occupants using the remote control.
- The video screen displays information in a split screen format. The left side of the screen is referred to as Channel 1 and the right side of the screen is referred to as Channel 2. All modes except video modes are displayed in a split screen format.

- To use the headphones, press the power button located on the right ear cup. Select the channel on the headphones (1 or 2) that corresponds to the channel selected on the VES[™] screen.

Operation Of The Touch-Screen Radio

- To view a DVD video press the OPEN/CLOSE hard-key and insert the disc. Playback will begin automatically after the DVD is recognized by the disc drive. If playback does not begin automatically follow these steps:
 - Press the MENU hard-key, then touch the REAR VES[™] soft-key. If a chapter list appears on the right side of the screen touch the HIDE LIST soft-key to display the Rear VES[™] Control screen.
 - Touch the 1 soft-key to select an audio channel, then touch the DISC soft-key in the MEDIA column.

SIRIUS Backseat TV[™]

- Press the MENU hard-key, then touch the Rear VES[™] soft-key. If a chapter list appears on the right side of the screen, touch the HIDE LIST soft key to display the Rear VES[™] Control screen.
- Touch the 1 soft-key to select an audio channel, then touch the TV soft-key in the RADIO column to select SIRIUS Backseat TV[™].

Operation Of The Remote

- The remote control operates similarly to any DVD remote you have used before and allows the rear seat passengers to change stations, tracks, discs and audio/video modes.
- The remote control is designed to control either channel by using the selector switch located on the right side of the remote.
- Pressing the power button will turn the VES[™] system ON/OFF.
- Pressing the MODE button causes the Mode Selection menu to appear on the VES[™] screen. Use the remote control arrow buttons to scroll through the available modes, then press ENTER to select the desired mode.

SIRIUS Backseat TV™

- To view SIRIUS Backseat TV™ set the remote control channel selector switch to channel 1. Press the MODE button, then using the arrow buttons select TV and press ENTER.

Auxiliary Audio/Video Input Jacks

- The Aux jacks are located on the rear of the center console.
- Connect the video game or other external media devices to the AUX jacks following the color coding for VES™ jacks.
- Using either the touch-screen radio or remote control, select AUX from the Rear VES™ Control or Mode Selection screen.
- Refer to “uconnect™ studios” in the uconnect™ User's Manual on the DVD for further details.

UNIVERSAL CONSUMER INTERFACE



- This feature allows you to plug an iPod® into the vehicle's sound system through a 16-pin connector using the provided interface cable.

- The 16-pin connector port is located in the glove box or on the center console. Location may vary. To get into the UCI (iPod®) mode from a non-touch-screen radio, press the 'AUX' button on the radio faceplate. From touch-screen radios press the MEDIA hard-key, then touch the iPod® soft-key. When connected to this feature:
 - The iPod® audio can be played on the vehicle's sound system.
 - The iPod® can be controlled using the radio buttons to Play, Browse, and List the iPod® contents. Refer to the Owner's Manual on the DVD for details.
 - The iPod® battery charges when plugged into the UCI connector.





WARNING!

Do not plug in or remove the iPod® while driving. Failure to follow this warning could result in an accident.

ELECTRONICS

ELECTRONIC VEHICLE INFORMATION CENTER (EVIC)



- The EVIC features a driver interactive display that is located in the instrument cluster. Pressing the controls on the steering wheel allows the driver to select vehicle information and Personal Settings. For additional information refer to Programmable Features in this guide.
- Press and release the UP  button to scroll upward through the menus.
- Press and release the DOWN  button to scroll downward through the menus.
- Press and release the SELECT  button for access to main menus or to select a personal setting in the setup menu.
- Press the BACK  button to scroll back to a previous menu.

UNIVERSAL GARAGE DOOR OPENER



Programming HomeLink®

Begin Programming

- The HomeLink® buttons are located in the overhead console.
 - Erase all channels before you begin training by holding the two outside buttons for up to 20 seconds until "CHANNELS CLEARED" appears in the EVIC display.
 - Park your vehicle outside of the garage and turn the ignition switch to the ON/RUN position.
- Place the hand-held transmitter 1 to 3 in (3 to 8 cm) from the HomeLink® buttons while keeping the EVIC display in view. Simultaneously, press and hold both the chosen HomeLink® button and the hand-held transmitter button until the EVIC display changes from "CHANNEL # TRAINING" to "CHANNEL # TRAINED." This may take up to 30 seconds, or longer, in rare cases.
 - Press and hold the just-trained HomeLink® button; if the channel has been trained, the EVIC display will show "CHANNEL # TRANSMIT" and the device should operate.

NOTE: If you are having difficulty training your HomeLink® and your garage door was manufactured after 1995, you may have a rolling code system. Follow the steps for programming a rolling code system.

Programming A Rolling Code System

- At the garage door opener motor (in the garage), locate the “learn” or “training” button. This can usually be found where the hanging antenna wire is attached to the garage door opener motor (it is NOT the button normally used to open and close the door).
- Firmly press and release the “learn” or “training” button. The name and color of the button may vary by manufacturer. Within 30 seconds, return to the vehicle and press the programmed HomeLink[®] button twice (holding the button for two seconds each time). If the device is plugged in and activates, programming is complete.
- If the device does not activate, press the button a third time (for two seconds) to complete the training.

Using HomeLink[®]

- To operate, simply press and release the programmed HomeLink[®] button and the trained device will operate.
- Refer to your Owner’s Manual on the DVD for further details. If you have any problems programming HomeLink[®], or require assistance, please call toll-free 1-800-355-3515, or on the Internet, at www.HomeLink.com.

POWER INVERTER



- A 115-Volt 150-watt power inverter outlet is located on the lower instrument panel next to the climate control knob. This outlet can power cellular phones, electronics and other low power devices requiring power up to 150 watts.
- To turn on the power outlet, press the switch once.
- Press the switch a second time to turn the power outlet off. The status indicator of the AC power inverter indicates whether the inverter is producing AC power.

NOTE: The power inverter is designed with built-in overload protection. If the power rating of 150 watts is exceeded, the power inverter will automatically shut down. Once the electrical device has been removed from the outlet the inverter should automatically reset. If the power rating exceeds approximately 170 watts, the power inverter may have to be reset manually. To reset the inverter manually, press the power inverter button OFF and ON. To avoid overloading the circuit, check the power ratings on electrical devices prior to using the inverter.

WARNING!

To avoid serious injury or death: Do not use a three-prong adapter. Do not insert any objects into the receptacles. Do not touch with wet hands. Close the lid when not in use. If this outlet is mishandled it may cause an electric shock and failure.

ELECTRONICS

POWER OUTLET

- There are four 12-volt power outlets located in the vehicle. Lower left and lower right of the instrument Panel– without floor mounted shifter. Inside the top storage tray – with floor mounted shifter. Inside the upper lid of the center storage compartment. Rear of the center console storage compartment – Quad Cab or Crew Cab. The power outlet(s) are direct feed from the battery and receive power whether the ignition is ON or OFF. All accessories connected to the outlet(s) should be removed or turned off when the vehicle is not in use to protect the battery against discharge.

NOTE: Do not exceed the maximum power of 160 Watts (13 Amps) at 12 Volts. If the 160 Watt (13 Amp) power rating is exceeded the fuse protecting the system will need to be replaced.

uconnect™ phone

- The uconnect™ phone is a voice-activated, hands-free, in-vehicle communications system.
- The uconnect™ phone allows you to dial a phone number with your cellular phone using simple voice commands.
- Please refer to uconnect™ phone in the uconnect™ User's Manual on the DVD for further details.

WARNING!

- Any voice commanded system should be used only in safe driving conditions following local laws and phone use. All attention should be kept on the roadway ahead. Failure to do so may result in an accident causing serious injury or death.
- Your phone must be turned on and paired to the uconnect™ phone to allow use of this vehicle feature in emergency situations, when the cellular phone has network coverage and stays paired to the uconnect™ phone.

NOTE: The uconnect™ phone requires a cellular phone equipped with the Bluetooth® Hands-Free Profile, Version 0.96 or higher. For uconnect™ customer support, call 1-877-855-8400.

Phone Pairing

NOTE: Pairing is a one-time initial setup before using the phone. You will also need to follow the Bluetooth instructions in your cell phone user guide to complete the phone pairing setup.

- Press the Phone button  to begin.
- Wait for the “ready” prompt and beep.
- (After the BEEP), say “uconnect setup”.
- (After the BEEP), say “phone pairing”.
- (After the BEEP) say, “pair a phone”.
- Follow the audible prompts.
- You will be asked to create a four-digit PIN which you will later need to enter into your phone (typically..settings, bluetooth, device, list, new).

- You will then be prompted to give the phone pairing a name (each phone paired should have a unique name).
- Next you will be asked to give this new pairing a priority of 1 thru 7 (up to seven phones may be paired).



Making A Phone Call

- Press the Phone button .
- (After the BEEP), say “dial” (or “call” to a name).
- (After the BEEP), say number (or name).

Phonebook (uconnect™ local) Edit

- Press the Phone button .
- (After the BEEP), say “phonebook”.
- (After the BEEP), say “new entry” or “list names” or “delete”.
- Follow the prompts.

Receiving A Call – Accept (And End)

- When an incoming call rings / is announced on uconnect™, press the Phone button .
- To end a call, press the Phone button .

Mute (Or Unmute) Microphone During Call

- During a call, press the Voice button .
- (After the BEEP), say “mute on” (or “mute off”).

Transfer Ongoing Call Between Handset And Vehicle

- During a call, press the Voice button .
- (After the BEEP), say “transfer call”.



Changing The Volume

- Start a dialogue by pressing the Phone button , then adjust the volume during a normal call.
- Use the radio ON/OFF VOLUME rotary knob to adjust the volume to a comfortable level while the uconnect™ system is speaking. Please note the volume setting for uconnect™ is different than the audio system.

NOTE: To access the tutorial, press the uconnect™ hard-key. After the BEEP, say “tutorial”. Press any hard-key or touch the display to cancel the tutorial.

ELECTRONICS

VOICE RECOGNITION

- The Voice Recognition (VR) system allows you to control your AM, FM radio, satellite radio, disc player, and a memo recorder. When you press the VR button , you will hear a beep. The beep is your signal to give a command. If you do not say a command within a few seconds, the system will present you with a list of options. If you ever wish to interrupt the system while it lists options, press the VR button , listen for the BEEP, and say your command.
- Please refer to uconnect™ tunes in the uconnect™ User's Manual on the DVD for further details.

Changing The Volume

- Start a dialogue by pressing the VR button , then say a command (e.g., “tutorial”).
- Use the radio ON/OFF VOLUME rotary knob to adjust the volume to a comfortable level while the Voice Recognition system is speaking. Please note the volume setting for Voice Recognition is different than the audio system.

WARNING!

Any voice commanded system should be used only in safe driving conditions and all attention should be kept on the roadway ahead. Failure to do so may result in an accident causing serious injury or death.

NOTE: To access the tutorial, press the VR button . After the BEEP, say “tutorial”. Press any hard-key or touch the display to cancel the tutorial.

OFF-ROAD CAPABILITIES

FOUR-WHEEL DRIVE OPERATION

Four-Position Transfer Case

- The transfer case provides four mode positions.
 - Two-wheel drive high range (2H)
 - Four-wheel drive high range (4H)
 - NEUTRAL (N)
 - Four-wheel drive low range (4L)
- This transfer case is intended to be driven in the 2H position for normal street and highway conditions such as dry, hard-surfaced roads.
- When additional traction is required, the 4H and 4L positions can be used to lock the front and rear driveshafts together.
- When operating your vehicle in 4L, do not exceed 25 mph (40 km/h).

Shifting Procedure

- Shifting between 2H and 4H can be made with the vehicle stopped or in motion at speeds up to 55 mph (88 km/h).
- Shifting between 2H or 4H and 4L can be made with the vehicle rolling at 2 to 3 mph (3 to 5 km/h).

Five-Position Transfer Case

- This electronically shifted transfer case provides five mode positions:
 - Two-wheel drive high range (2WD)
 - Four-wheel drive automatic range (4WD AUTO)
 - Four-wheel drive lock range (4WD LOCK)
 - Four-wheel drive low range (4WD LOW)
 - NEUTRAL (N)

- This electronically shifted transfer case is designed to be driven in the two-wheel drive position (2WD) or four-wheel drive position (4WD AUTO) for normal street and highway conditions on dry, hard-surfaced roads.
- Driving the vehicle in 2WD will have greater fuel economy benefits as the front axle is not engaged in 2WD.

Shifting Procedure

- Shifting between 2H and 4WD AUTO or 4WD LOCK can be made with the vehicle stopped or in motion.
- Shifting between 2H or 4H and 4L can be made with the vehicle stopped or rolling at 2 to 3 mph (3 to 5 km/h).

NOTE: It is preferred to have the engine running and the vehicle moving at 2 to 3 mph (3 to 5 km/h).

WARNING!

You or others could be injured if you leave the vehicle unattended with the transfer case in the NEUTRAL position without first fully engaging the parking brake. The transfer case NEUTRAL position disengages both the front and rear driveshafts from the powertrain and will allow the vehicle to move regardless of the transmission position. The parking brake should always be applied when the driver is not in the vehicle.

UTILITY

EASY-OFF TAILGATE

- To simplify mounting of a camper unit with an overhang, the tailgate can be removed.

NOTE: If your vehicle is equipped with a rear camera the electrical connector must be disconnected prior to removing the tailgate.

Removing the Tailgate

- Disconnect the wiring harness for the rear camera (if equipped).
- Unlatch the tailgate and remove the support cables by releasing the lock tang from the pivot.
- Raise the right side of the tailgate until the right side pivot clears the hanger bracket.
- Slide the entire tailgate to the right to free the left side pivot.
- Remove the tailgate from the vehicle.

NOTE: Do not carry the tailgate loose in the truck pickup box.

WARNING!

To avoid inhaling carbon monoxide, which is deadly, the exhaust system on vehicles equipped with “Cap or Slide-In Campers” should extend beyond the overhanging camper compartment and be free of leaks.

Locking Tailgate

The lock is located next to the tailgate handle. The tailgate can be locked using the vehicle key.

RAMBOX®



- The RamBox® system is an integrated pickup box storage and cargo management system consisting of three features:
 - Integrated box side storage bins
 - Cargo extender/divider
 - Bed rail tie-down system

RamBox® Integrated Box Side Storage Bins

- The cargo storage bins provide watertight, lockable, illuminated storage for up to 150 lbs (68 kg) of evenly distributed cargo.

CAUTION!

Failure to follow the following items could cause damage to the vehicle:

- Assure that all cargo inside the storage bins is properly secured.
 - Do not exceed cargo weight rating of 150 lb (68 kg) per bin.
- To open a storage bin, press and release the pushbutton located on the lid.

UTILITY

- The interior of the RamBox[®] will automatically illuminate when the lid is opened. Pushing the switch once will turn off the bin lights, pushing the switch again will turn the lights back on.

CAUTION!

Leaving the lid open for extended periods of time could cause the vehicle battery to discharge. If the lid is required to stay open for extended periods of time, it is recommended that the bin lights be turned off manually using the on/off switch.

CAUTION!

- Ensure cargo bin lids are closed and latched before moving or driving vehicle.
- Loads applied to the top of the bin lid should be minimized to prevent damage to the lid and latching/hinging mechanisms.
- Damage to the RamBox[®] bin may occur due to heavy/sharp objects placed in bin that shift due to vehicle motion. In order to minimize potential for damage, secure all cargo to prevent movement and protect inside surfaces of bin from heavy/sharp objects with appropriate padding.
- Cargo bins feature two removable drain plugs (to allow water to drain from bins). To remove plug, pull up on the edge. To install, push plug downward into drain hole.
- The RamBox[®] storage bins can be locked using the vehicle key.

NOTE: Provisions are provided in the bins for cargo dividers and shelf supports. These accessories (in addition to other RamBox[®] accessories) are available from MOPAR[®].

RamBox[®] Safety Warning

- Carefully follow these warnings to help prevent personal injury or damage to your vehicle:

WARNING!

- Always close the storage bin covers when your vehicle is unattended or in motion.
- Do not allow children to have access to the storage bins. Once in the storage bin, young children may not be able to escape. If trapped in the storage bin, children can die from suffocation or heat stroke.
- In an accident, serious injury could result if the storage bin covers are not properly latched.
- Do not use a storage bin latch as a tie down.

RamBox[®] Storage Bin Cover Emergency Release Lever

- As a security measure, a Storage Bin Cover Emergency Release is built into the storage bin cover latching mechanism.

NOTE: In the event of an individual being locked inside the storage bin, the storage bin cover can be opened from inside of the bin by pulling on the glow-in-the-dark lever attached to the storage bin cover latching mechanism.

Bed Extender

- The bed extender has three functional positions:
 - Storage Position
 - Divider Position
 - Extender Position

Storage Position

- The storage position for the bed extender is at the front of the truck bed.
- To install the bed extender into the storage position, perform the following:
 - Make sure the center handle is unlocked using the vehicle key and rotate the center handle vertically to release the extender side gates.
 - With the side gates open, position the extender fully forward in the bed against the front panel.
 - Rotate the side gates closed allowing the outboard ends to be positioned in front of the cargo tie-down loops.
 - Rotate the center handle horizontally to secure the side gates in the closed position.
 - Lock the center handle using the vehicle key to secure the panel into place and assist against theft.

Divider Position

- There are 11 divider slots along the bed inner panels which allow for various positions to assist in managing your cargo.
- To install the bed extender into a divider position perform the following:
 - Make sure the center handle is unlocked using the vehicle key and rotate the center handle vertically to release the extender side gates.
 - With the side gates open, position the extender so the outboard ends align with the intended slots in the sides of the bed.
 - Rotate the side gates closed so that the outboard ends are secured into the intended slots of the bed.
 - Rotate the center handle horizontally to secure the side gates in the closed position.
 - Lock the center handle to secure the panel into place and assist against theft.

Extender Position

- The bed extender will add an additional 15 in (38 cm) in the back of the truck when additional cargo room is needed.
- To install the bed extender into the extender position, perform the following:
 - Lower the tailgate.
 - Make sure the center handle is unlocked and rotate the center handle vertically in order to release the extender side gates.
 - Fit the end of the side gate ends onto the pin and handle.
 - Rotate the handles to the horizontal position to secure into place.

WARNING!

To reduce the risk of potential injury or property damage:

- Cargo must be secured.
- Do not exceed cargo load rating of your vehicle.
- Secure all loads to truck utilizing cargo tie-downs.
- Extender should not be used as cargo tie-down.
- When vehicle is in motion do not exceed 150 lbs (68 kg) load on the tailgate.
- The bed extender is not intended for off road use.
- When not in use, the extender/divider should be in stowed or divider position with the tailgate closed.
- When in use, all handles are to be in the locked position.

Bed Rail Tie-Down System

CAUTION!

The maximum load per cleat should not exceed 250 lbs (113 kg) and the angle of the load on each cleat should not exceed 60 degrees above horizontal, or damage to the cleat or cleat rail may occur.

- There are two adjustable cleats on each side of the bed that can be used to assist in securing cargo.
- Each cleat must be located and tightened down in one of the detents, along either rail, in order to keep cargo properly secure.
- To move the cleat to any position on the rail, turn the nut counterclockwise, approximately three turns. Then, pull out on the cleat and slide it to the detent nearest the desired location. Make sure the cleat is seated in the detent and tighten the nut.
- To remove the cleats from the utility rail, remove the end cap by pushing up on the locking tab, located on the bottom of the end cap. Slide the cleat off the end of the rail.

TRAILER TOWING WEIGHTS (MAXIMUM TRAILER WEIGHT RATINGS)

NOTE: For additional trailer towing information (maximum trailer weight ratings) refer to the following website addresses:

- [http:// www.dodge.com](http://www.dodge.com).
- [http:// www.dodge.ca](http://www.dodge.ca) (Canada).

RECREATIONAL TOWING (BEHIND MOTORHOME, ETC.)

Recreational Towing – Two-Wheel Drive Models

- Recreational towing of two-wheel drive models is not allowed. Towing with the rear wheels on the ground can result in severe transmission damage.

Recreational Towing – Four-Wheel Drive Models

CAUTION!

Failure to follow these requirements can cause severe damage to the transmission and/or transfer case.

NOTE: Both the manual shift and electronic shift transfer cases must be shifted into NEUTRAL for recreational towing. Automatic transmissions must be shifted into the PARK position for recreational towing. Refer to the following for the proper transfer case NEUTRAL shifting procedure for your vehicle.

Recreational Towing Procedure – Manual Shift Transfer Case

- Bring the vehicle to a complete stop, shut off the engine and depress the brake pedal.
- Shift the transmission and transfer case into NEUTRAL.
- Start the engine and shift the transmission into REVERSE.
- Release the brake pedal for five seconds and ensure that there is no vehicle movement.
- Repeat the previous two steps with the transmission in DRIVE.
- Shut OFF the engine and place the ignition key in the unlocked OFF position.
- Shift the transmission into PARK and apply the parking brake.

- Attach the vehicle to the tow vehicle with the tow bar and release the parking brake.

Recreational Towing Procedure — Electronic Shift Transfer Case

- Use the following procedure to prepare your vehicle for recreational towing:
- Bring the vehicle to a complete stop, turn the ignition key to the ON position, but do not start the engine.
- Press the brake pedal and shift the transmission into NEUTRAL.
- Press and hold the transfer case switch NEUTRAL button for four seconds.
- After the shift is completed and the NEUTRAL light turns on, release the NEUTRAL button.
- Start the engine and shift the transmission into REVERSE.
- Release the brake pedal for five seconds and ensure that there is no vehicle movement.
- Repeat the previous two steps with the transmission in DRIVE.
- Turn the engine OFF and place the ignition key in the unlocked OFF position.
- Shift the transmission into PARK and apply the parking brake.
- Attach the vehicle to the tow vehicle with the tow bar and release the parking brake.

NOTE:

- The first two steps are requirements that must be met prior to depressing the NEUTRAL button, and must continue to be met until the four seconds elapses and the shift has been completed. If any of these requirements (with the exception of Key ON) are not met prior to depressing the NEUTRAL button or are no longer met during the four second timer, then the NEUTRAL indicator light will flash continuously until all requirements are met or until the NEUTRAL button is released.

- The flashing NEUTRAL indicator light indicates that shift requirements have not been met.
- Refer to your Owner's Manual on the DVD for further details.

BRAKE/TRANSMISSION INTERLOCK MANUAL OVERRIDE

- Your vehicle may be equipped with a shift lock manual override.
- The manual override may be used in the event that the shift lever should fail to move from PARK with the key in the ON position and the brake pedal pressed.

Column Shifter

- Turn the Key Fob to the ACC or ON position without starting the engine.
- Tilt the steering wheel to the full up position and firmly set the parking brake.
- Press and maintain firm pressure on the brake pedal.
- Using a screwdriver, press and hold the override tab through the access port (ringed circle) on the bottom of the steering column.
- Move the shift lever into the NEUTRAL position and start the vehicle.

Center Console Shifter

- Turn the Key Fob to the ACC or ON position without starting the engine.
- Firmly set the parking brake and press and maintain firm pressure on the brake pedal.
- Using a screwdriver, press and hold the override tab through the access port on the center console.
- Move the shift lever into the NEUTRAL position and start the vehicle.
- Have your vehicle inspected by your local authorized dealer if the shift lock manual override has been used.

WHAT TO DO IN EMERGENCIES

24 HOUR TOWING ASSISTANCE

- Dial toll-free 1-800-521-2779.
- Provide your name, vehicle identification number and license plate number.
- Provide your location, including telephone number, from which you are calling.
- Briefly describe the nature of the problem and answer a few simple questions.
- You will be given the name of the service provider and an estimated time of arrival. If you feel you are in an “unsafe situation”, please let us know. With your consent, we will contact local police or safety authorities.

INSTRUMENT CLUSTER WARNING LIGHTS

- Electronic Stability Program (ESP) Indicator Light

- If this indicator light flashes during acceleration, apply as little throttle as possible. While driving, ease up on the accelerator. Adapt your speed and driving to the prevailing road conditions. To improve the vehicles traction when starting off in deep snow, sand or gravel, it may be desirable to switch the ESP system off.

- Tire Pressure Monitoring System (TPMS) Light

- A Tire Pressure Monitoring Light and a “low tire” message will display in your instrument cluster along with an audible chime if one or more of your vehicle’s four road tires are significantly under-inflated.
- Check the inflation pressure of each tire and inflate to the recommended pressure for your vehicle. The tire pressures recommended for your vehicle are found on the “Tire and Loading Information” label located on the driver’s side door opening. The TPMS light should not be used as a tire pressure gauge when adjusting your tire pressure.
- It is recommended that you check the tire pressure in the morning when tires are cool; inflate each tire to the recommended pressure for your vehicle. The light will turn off after your vehicle’s tire pressures are properly inflated and the pressure has been recognized. The vehicle may need to be driven for up to 20 minutes above 15 mph (25 km/h) before the light will turn off.
- Temperature changes can affect tire pressure, causing the TPMS light to turn on. Tire pressures will also increase as the vehicle is driven – this is normal and you should not adjust for this increased pressure.
- Driving on under-inflated tires reduces your vehicle’s fuel efficiency and tire tread life. If a spare tire is in use on the vehicle, the TPMS light may turn on.

- Engine Temperature Warning Light

- This light warns of an overheated engine condition.
- If the light turns on and a warning chime sounds while driving, safely pull over and stop the vehicle. If the A/C system is on, turn it off. Also, shift the transmission into NEUTRAL and idle the vehicle. If the temperature reading does not return to normal, turn the engine off immediately.
- We recommend that you do not operate the vehicle or engine damage will occur. Have the vehicle serviced immediately.

WHAT TO DO IN EMERGENCIES

WARNING!

A hot engine cooling system is dangerous. You or others could be badly burned by steam or boiling coolant. You may want to call an authorized dealership for service if your vehicle overheats.

BRAKE - Brake Warning Light

- The Brake Warning light illuminates when there is either a system malfunction or the parking brake is applied. If the light is on and the parking brake is not applied, it indicates a possible brake hydraulic malfunction, brake booster problem or an Anti-Lock Brake System problem.
- We recommend you drive to the nearest Service Center and have the vehicle serviced immediately.

WARNING!

Driving a vehicle with the red brake light on is dangerous. Part of the brake system may have failed. It will take longer to stop the vehicle. You could have an accident. Have the vehicle checked immediately.

- **Malfunction Indicator Light (MIL)**

- Certain conditions, such as a loose or missing gas cap, poor fuel quality, etc., may illuminate the MIL after engine start. The vehicle should be serviced if the light stays on through several typical driving cycles. In most situations, the vehicle will drive normally and not require towing.
- If the MIL flashes when the engine is running, serious conditions may exist that could lead to immediate loss of power or severe catalytic converter damage. We recommend you do not operate the vehicle. Have the vehicle serviced as soon as possible if this occurs.

ESP BAS - **Electronic Stability Program (ESP) Indicator Light/Brake Assist System (BAS) Warning Light**

- If the ESP/BAS warning light comes on continuously with the engine running, a malfunction has been detected.
- If this light remains on after several ignition cycles, and the vehicle has been driven several miles (kilometers) at speeds greater than 30 mph (48 km/h), we recommend you drive to the nearest Service Center as soon as possible to have the problem diagnosed and corrected.

- **Charging System Light**

- This light shows the status of the electrical charging system. If the charging system light remains on, it means that the vehicle is experiencing a problem with the charging system.
- We recommend you do not continue driving if the charging system light is on. Have the vehicle serviced immediately.

WHAT TO DO IN EMERGENCIES

- Oil Pressure Warning Light

- This light indicates low engine oil pressure. If the light turns on while driving, stop the vehicle and shut off the engine as soon as possible. A chime will sound for four minutes when this light turns on.
- We recommend you do not operate the vehicle or engine damage will occur. Have the vehicle serviced immediately.

- Anti-Lock Brake (ABS) Light

- This light monitors the Anti-Lock Brake System (ABS).
- If the light is not on during starting, stays on, or turns on while driving, we recommend you drive to the nearest Service Center and have the system serviced as soon as possible.

- Electronic Throttle Control (ETC) Light

- This light informs you of a problem with the Electronic Throttle Control (ETC) system.
- If a problem is detected, the light will come on while the engine is running. Cycle the ignition when the vehicle has completely stopped and the shift lever is placed in the PARK position; the light should turn off.
- If the light remains lit with the engine running, your vehicle will usually be drivable; however, see an authorized dealer for service as soon as possible. If the light is flashing when the engine is running, immediate service is required and you may experience reduced performance, an elevated/rough idle or engine stall and your vehicle may require towing.

- Airbag Warning Light

- If the light is not on during starting, stays on, or turns on while driving, we recommend you drive to the nearest Service Center and have the system serviced as soon as possible.

- SERV (Service) 4WD Indicator Light

- If the light stays on or comes on during driving, it means that the 4WD system is not functioning properly and that service is required. We recommend you drive to the nearest Service Center and have the system serviced as soon as possible.

- Transmission Temperature Warning Light

- This light indicates that there is excessive transmission fluid temperature that might occur with severe usage such as trailer towing. If this light comes on, stop the vehicle and run the engine at idle, with the transmission in NEUTRAL, until the light turns off. Once the light turns off you may continue to drive normally.

Fuel Cap/Loose Gas Cap Message

- If a “gas cap” message (shown as gASCAP) appears, tighten the gas cap until a “clicking” sound is heard.
- Press the odometer reset button to turn the message off.
- If the message continues to appear for more than three days after tightening the gas cap, see your dealer.

WHAT TO DO IN EMERGENCIES

Oil Change Indicator

Message

- If an “oil change” message (shown as CHAnGE OIL) appears and a single chime sounds, it is time for your next required oil change.

Resetting The Light After Servicing

- Turn the ignition switch to the ON/RUN position (do not start engine).
- Fully depress the accelerator pedal three times within 10 seconds.
- Turn the ignition switch to the OFF/LOCK position.

IF YOUR ENGINE OVERHEATS

- In any of the following situations, you can reduce the potential for overheating by taking the appropriate action.
 - On the highways — slow down.
 - In city traffic — while stopped, shift transmission into NEUTRAL, but do not increase engine idle speed.

NOTE: There are steps that you can take to slow down an impending overheat condition:

- If your air conditioner (A/C) is on, turn it off. The A/C system adds heat to the engine cooling system and turning the A/C off can help remove this heat.
- You can also turn the Temperature Control to maximum heat, the Mode Control to floor and the Fan Control to high. This allows the heater core to act as a supplement to the radiator and aids in removing heat from the engine cooling system.
- If the temperature reading does not return to normal, turn the engine off immediately.
- We recommend that you do not operate the vehicle or engine damage will occur. Have the vehicle serviced immediately.

CAUTION!

Driving with a hot cooling system could damage your vehicle. If the temperature gauge reads HOT (H), pull over and stop the vehicle. Idle the vehicle with the air conditioner turned off until the pointer drops back into the normal range. If the pointer remains on HOT (H), and you hear continuous chimes, turn the engine off immediately and call for service.

WARNING!

You or others can be badly burned by hot engine coolant (antifreeze) or steam from your radiator. If you see or hear steam coming from under the hood, do not open the hood until the radiator has had time to cool. Never try to open a cooling system pressure cap when the radiator or coolant bottle is hot.

WHAT TO DO IN EMERGENCIES

JACKING AND TIRE CHANGING

WARNING!

- Do not attempt to change a tire on the side of the vehicle close to moving traffic. Pull far enough off the road to avoid the danger of being hit when operating the jack or changing the wheel.
- Getting under a jacked-up vehicle is dangerous. The vehicle could slip off the jack and fall on you. You could be crushed. Never get any part of your body under a vehicle that is on a jack. If you need to get under a raised vehicle, take it to a service center where it can be raised on a lift.
- The jack is designed to use as a tool for changing tires only. The jack should not be used to lift the vehicle for service purposes. The vehicle should be jacked on a firm level surface only. Avoid ice or slippery areas.
- If it is necessary to retrieve the spare tire from under the vehicle on the side of the vehicle close to moving traffic, pull far enough off the road to avoid the danger of being hit.

Jack Location



- The jack and jack tools are stored under the front passenger seat.
- Remove the plastic access cover, located on the side of the seat, by pulling the front part of the cover (closest to the front of the seat) toward you to release a locking tab.
- Once the front of the cover is loose, slide the cover toward the front of the seat until it is free from the seat frame.
- Remove the jack and tools by removing the wing bolt and sliding the assembly from under the seat.

Spare Tire Stowage

NOTE: Remove the spare tire before attempting to jack up the truck.

- To remove the spare tire, remove the jack-handle components from the storage area and assemble them.
- Attach the wheel wrench to the jack extension tube and insert the tube through the access hole in the rear bumper and into the winch mechanism tube.
- Rotate the wheel wrench handle counterclockwise until the spare tire is on the ground with enough cable slack to allow you to pull it out from under the vehicle.
- When the spare is clear, tilt the retainer at the end of the cable and pull it through the center of the wheel.

WHAT TO DO IN EMERGENCIES

Preparations For Jacking

- Park on a firm, level surface. Avoid ice or slippery areas.
- Set the parking brake and shift the automatic transmission into PARK, or a manual transmission into REVERSE. On Four-Wheel Drive vehicles, shift the transfer case to the 4L position.
- Turn the ignition to LOCK and turn on the Hazard Warning flasher.
- Block both the front and rear of the wheel diagonally opposite of the jacking position. For example, if changing the right front tire, block the left rear wheel.



Hub Caps/Wheel Covers — If Equipped

- The hub caps must be removed before raising the vehicle off the ground.
- For 2500/3500 single rear-wheel (SRW) models, use the blade on the end of the lug wrench to pry the hub cap off. Insert the blade end into the pry-off notch and carefully pop off the hub cap with a back-and-forth motion.
- On 3500 models with dual rear wheels (DRW), position the hook on the jack handle driver into the notch on the hub cap and pull out on the ratchet firmly. The hub cap should pop off. The wheel skins can now be removed. For the front hub cap on 3500 models, use the blade on the end of the lug wrench to pry the caps off. The wheel skins can now be removed by using the flat end of the lug wrench to pry them off. Insert the flat tip completely and using a back-and-forth motion, loosen the wheel skin.

NOTE: Passengers should not remain in the vehicle when the vehicle is being jacked.

WHAT TO DO IN EMERGENCIES

Jacking And Tire Changing Instructions

WARNING!

Carefully follow these tire changing procedures to help prevent personal injury or damage to your vehicle: Always park on a firm, level surface as far from the edge of the roadway as possible before raising the vehicle.

- Remove the spare tire, jack and tools from the stored location.
- Loosen (but do not remove) the wheel lug nuts by turning them to the left one turn while the wheel is still on the ground.
- Assemble the jack and jacking tools. Connect the jack handle driver to the extension, then to the lug wrench.
- Place the jack:

1500-Series Trucks

- For front wheels, place the scissors jack under the rear portion of the lower control arm.

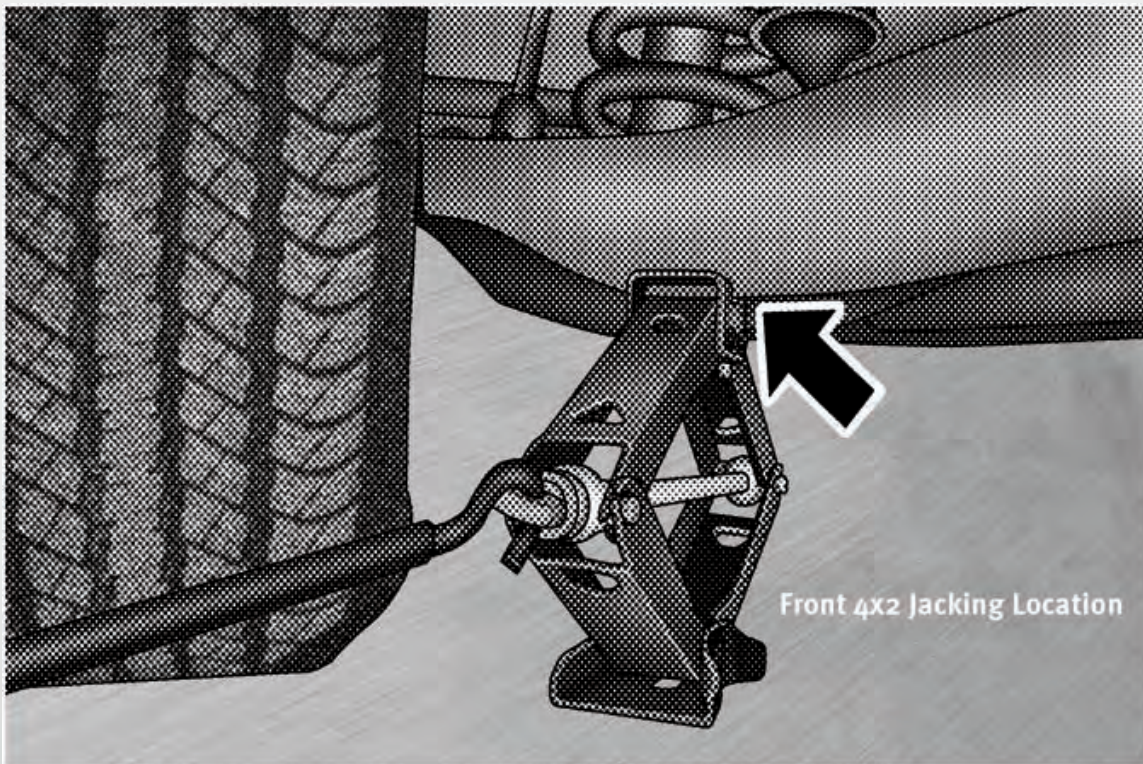

WHAT TO DO IN EMERGENCIES

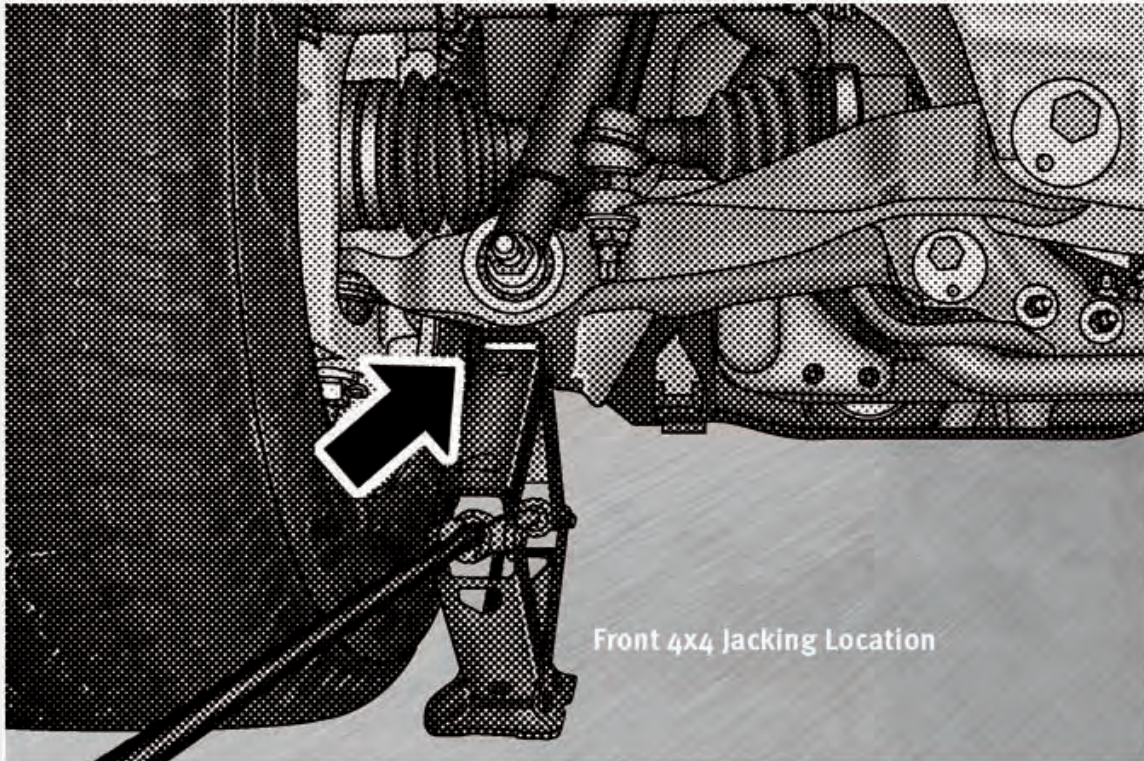

- For rear wheels, place the jack under the axle between the wheel and the shock bracket with the jack drive tubes extending to the rear.
- Turn the jack screw clockwise to firmly engage the jack saddle with the lift area.

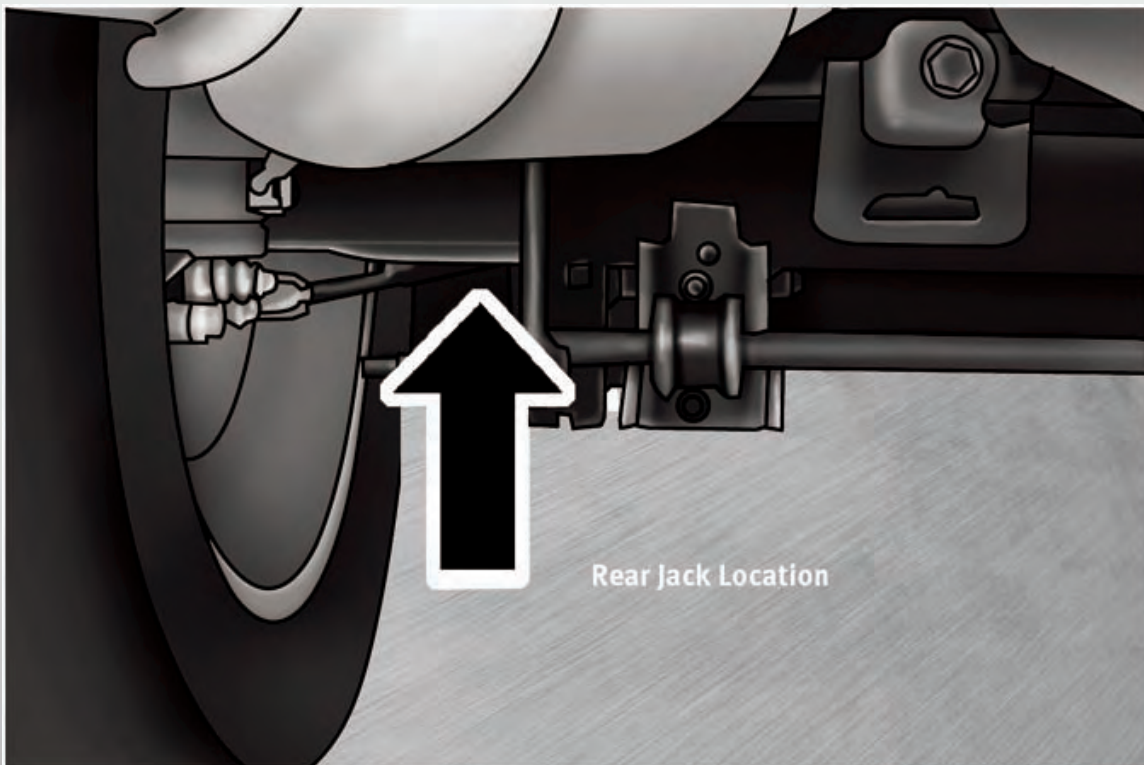

WHAT TO DO IN EMERGENCIES

2500/3500-Series Trucks

- For **4x2 front wheels**, place the bottle jack under the frame rail behind the wheel. Locate the jack as far forward as possible on the straight part of the frame.

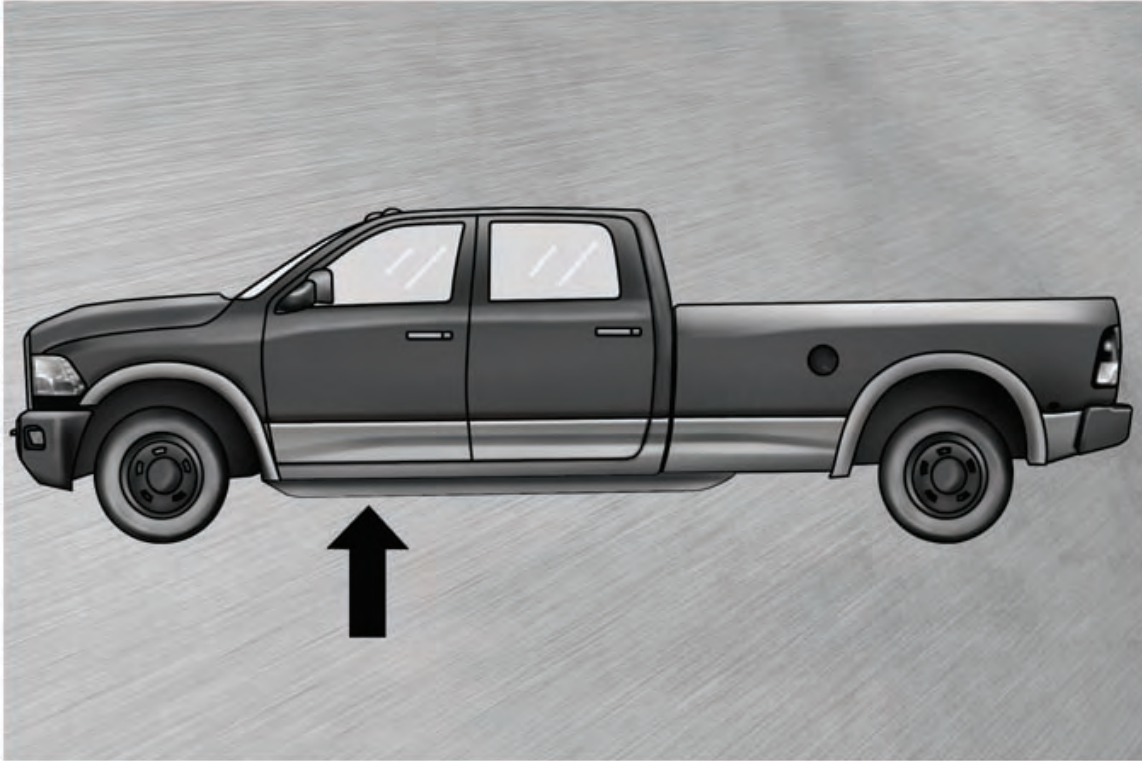

- For **4x4 front wheels**, place the jack under the axle as close to the tire as possible with the drive tubes extending to the front.



WHAT TO DO IN EMERGENCIES

- For **rear wheels**, place the jack under the axle between the spring and the shock absorber with the drive tubes extending to the rear.



CAUTION!

Before raising the wheel off the ground, make sure that the jack will not damage surrounding truck parts and adjust the jack position as required.

- Turn the jack screw clockwise to firmly engage the jack saddle with the lift area.
- Raise the vehicle by turning the jack screw clockwise. Raise the vehicle only until the tire just clears the surface and enough clearance is obtained to install the spare tire.

WARNING!

Raising the vehicle higher than necessary can make the vehicle less stable and cause an accident. It could slip off the jack and hurt someone near it. Raise the vehicle only enough to remove the tire.

- Remove the lug nuts and wheel.
- Position the spare wheel/tire on the vehicle and install the lug nuts with the cone-shaped end toward the wheel. Lightly tighten the lug nuts clockwise. To avoid the risk of forcing the vehicle off the jack, do not tighten the nuts fully until the vehicle has been lowered.
- Lower the vehicle by turning the jack screw to the left, and remove the jack and wheel blocks.

NOTE: If the bottle jack will not lower by turning the dial (thumbwheel) by hand, it may be necessary to use the jack drive tube in order to lower the jack.

- Finish tightening the lug nuts using a crisscross pattern. Push down on the wrench while tightening for increased leverage. The correct wheel nut tightness is:
 - 130 ft lbs (177 N·m) torque (1500 Series),
 - 135 ft lbs (183 N·m) torque for 2500/3500 single-rear wheel (SRW) models,
 - 145 ft lbs (197 N·m) for 3500 dual rear-wheel models.
- If in doubt about the correct tightness, have them checked with a torque wrench by your authorized dealer or at a service station.

WHAT TO DO IN EMERGENCIES

- Install the wheel center cap and remove the wheel blocks. Do not install chrome or aluminum wheel center caps on the spare wheel. This may result in cap damage.

WARNING!

A loose tire or jack, thrown forward in a collision or hard stop, could endanger the occupants of the vehicle. Always stow the jack parts and the spare tire in the places provided.

- Secure the tire, jack, and tools in their proper locations.
- Position the wheel so that the valve stem is facing the ground. Slide the wheel retainer through the center of the wheel and position it properly across the wheel opening.

NOTE: Aluminum wheels cannot be stored under the vehicle because the wheel retainer will not fit through the wheel pilot hole. Secure the flat tire in the bed of the truck. Have the flat tire repaired or replaced immediately.

JUMP-STARTING



WARNING!

Any procedure other than the following could result in:

- Personal injury caused by electrolyte squirting out the battery vent,
- Personal injury or property damage due to battery explosion,
- Damage to the charging system of the booster vehicle or of the immobilized vehicle.

WHAT TO DO IN EMERGENCIES

WARNING!

- Take care to avoid the radiator cooling fan whenever the hood is raised. It can start anytime the ignition switch is ON. You can be hurt by the fan.
 - Remove any metal jewelry, such as watch bands or bracelets, that might make an inadvertent electrical contact. You could be seriously injured.
 - Battery fluid is a corrosive acid solution; do not allow battery fluid to contact eyes, skin or clothing. Do not lean over a battery when attaching clamps or allow the clamps to touch each other. If acid splashes in your eyes or on skin, flush the contaminated area immediately with large quantities of water.
 - A battery generates hydrogen gas which is flammable and explosive. Keep flames or sparks away from the battery vent holes. Don't lean over the battery when attaching clamps or allow the clamps to touch each other.
 - Do not use a booster battery or any other booster source with an output that exceeds 12-volts (i.e., do not use a 24-volt power source).
- Check the battery test indicator (if equipped). If a light or bright colored dot is visible in the indicator, DO NOT jump-start the battery. If the indicator is dark or shows a green dot, proceed as follows:
 - Remove all metal jewelry, such as watch bands or bracelets, which might make an unintended electrical contact.

WARNING!

- Do not permit vehicles to touch each other as this could establish a ground connection and personal injury could result.
 - Do not connect the cable to the negative post of the discharged battery. The resulting electrical spark could cause the battery to explode and could result in personal injury.
- Park the booster vehicle within cable reach but without letting the vehicles touch. Set the parking brake on both vehicles, shift the automatic transmission into PARK, or the manual transmission into NEUTRAL, and turn the ignition to LOCK.
 - Turn off the heater, radio, and all unnecessary electrical loads.
 - Connect one end of a jumper cable to the positive terminal of the booster battery. Connect the other end of the same cable to the positive terminal of the discharged battery.
 - Connect the other cable, first to the negative terminal of the booster battery and then to the engine ground (-) of the vehicle with the discharged battery. Make sure you have a good contact on the engine ground.
 - Start the engine in the vehicle which has the booster battery; let the engine idle a few minutes.
 - Start the engine in the vehicle with the discharged battery.
 - When removing the jumper cables, reverse the above sequence exactly. Be careful of the moving belts and fan.

WHAT TO DO IN EMERGENCIES

WARNING!

During cold weather when temperatures are below the freezing point, electrolyte in a discharged battery may freeze. Do not attempt jump-starting because the battery could rupture or explode. The battery temperature must be brought up above the freezing point before attempting a jump-start.

EMERGENCY TOW HOOKS

- If your vehicle is equipped with tow hooks, they are mounted in the front and the rear.

NOTE: For off-road recovery, it is recommended to use both of the front tow hooks to minimize the risk of damage to the vehicle.

WARNING!

- Chains are not recommended for freeing a stuck vehicle. Chains may break, causing serious injury or death.
- Stand clear of vehicles when pulling with tow hooks. Tow straps and chains may break, causing serious injury.

CAUTION!

Tow hooks are for emergency use only, to rescue a vehicle stranded off road. Do not use tow hooks for tow truck hookup or highway towing. You could damage your vehicle. Tow straps are recommended when towing the vehicle; chains may cause vehicle damage.

WHAT TO DO IN EMERGENCIES

TOWING A DISABLED VEHICLE

Model	Flat Towing (all four wheels on the ground)	Flatbed Towing (all four wheels suspended OFF the ground)	Front Wheels Raised, Rear Wheels on the Ground	Rear Wheels Raised, Front Wheels on the Ground
Two-Wheel Drive - Transmission not operable	Not Permitted	Recommended Method	NOT Permitted without towing dolly	Not Permitted
Two-Wheel Drive - Transmission operable	Not Permitted	Recommended Method	Shift lever must be in NEUTRAL, the speed less than 30 mph (48 km/h) and the distance traveled less than 15 mi (24 km).	Shift lever must be In NEUTRAL
Four-Wheel Drive	Not Permitted	Recommended Method	Transfer case must be in NEUTRAL and transmission in PARK	Transfer case must be in NEUTRAL and transmission in PARK

WHAT TO DO IN EMERGENCIES

FREEING A STUCK VEHICLE

- If your vehicle becomes stuck in mud, sand or snow, it can often be moved by a rocking motion. Turn your steering wheel right and left to clear the area around the front wheels. Then, move the shift lever back and forth between REVERSE and DRIVE. Using minimal accelerator pedal pressure to maintain the rocking motion, without spinning the wheels, is most effective.
- Allow the engine to idle with the transmission shift lever in NEUTRAL for at least one minute after every five rocking-motion cycles. This will minimize overheating and reduce the risk of transmission failure during prolonged efforts to free a stuck vehicle.

NOTE: If your vehicle is equipped with Electronic Stability Program (ESP) or Traction Control , turn the system off before attempting to “rock” the vehicle.

WARNING!

Fast spinning tires can be dangerous. Forces generated by excessive wheel speeds may cause tire damage or failure. A tire could explode and injure someone. Do not spin your vehicle's wheels faster than 30 mph (48 km/h) when you are stuck. Do not let anyone near a spinning wheel, no matter what the speed.

CAUTION!

Revvng the engine or spinning the wheels too fast may lead to transmission overheating and failure. It can also damage the tires. Do not spin the wheels above 30 mph (48 km/h).

EVENT DATA RECORDER (EDR)

- This vehicle is equipped with an Event Data Recorder (EDR). The main purpose of an EDR is to record, in certain crash or near crash-like situations, such as an air bag deployment or hitting a road obstacle, data that will assist in understanding how a vehicle's systems performed. The EDR is designed to record data related to vehicle dynamics and safety systems for a short period of time, typically 30 seconds or less. The EDR in this vehicle is designed to record such data as:
 - How various systems in your vehicle were operating;
 - Whether or not the driver and passenger safety belts were buckled/fastened;
 - How far (if at all) the driver was depressing the accelerator and/or brake pedal; and,
 - How fast the vehicle was traveling.
- This data can help provide a better understanding of the circumstances in which a crash and injuries occur. NOTE: EDR data is recorded by your vehicle only if a non-trivial crash situation occurs; no data is recorded by the EDR under normal driving conditions and no personal data (e.g., name, gender, age, and crash location) is recorded. However, other parties, such as law enforcement, could combine the EDR data with the type of personally identifying data routinely acquired during a crash investigation.
- To read data recorded by an EDR, special equipment is required, and access to the vehicle or the EDR is needed. In addition to the vehicle manufacturer, other parties, such as law enforcement, that have the special equipment, can read the information if they have access to the vehicle or the EDR.

MAINTAINING YOUR VEHICLE

OPENING THE HOOD

- Pull the hood release lever located below the steering wheel at the base of the instrument panel.
- Reach into the opening beneath the center of the hood and move the safety latch lever while lifting the hood at the same time.

WARNING!

Be sure the hood is fully latched before driving your vehicle. If the hood is not fully latched, it could open when the vehicle is in motion and block your vision. Failure to follow this warning could result in serious injury or death.

MAINTAINING YOUR VEHICLE

ENGINE COMPARTMENT

3.7L Engine

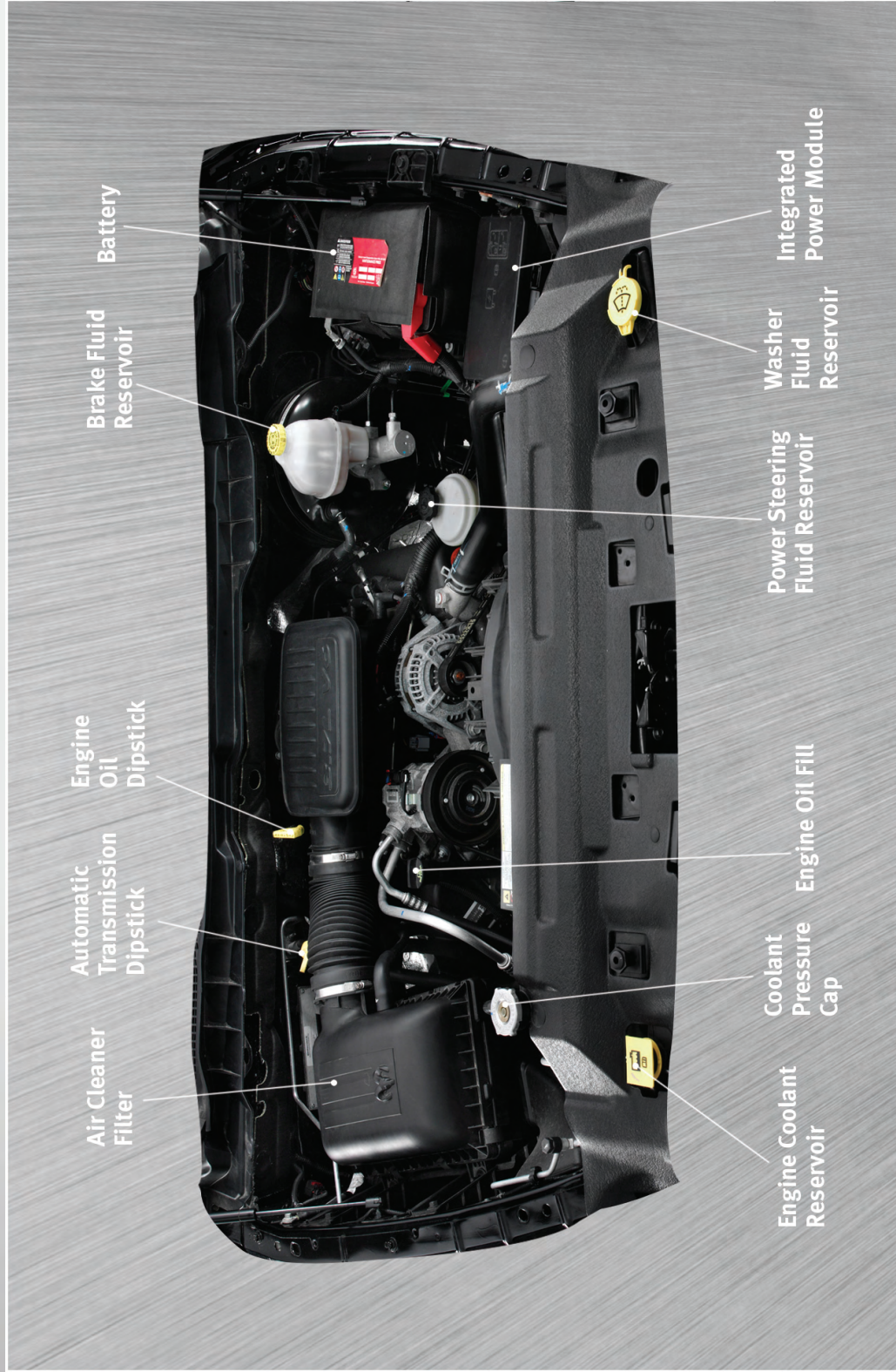

MAINTAINING YOUR VEHICLE

4.7L Engine

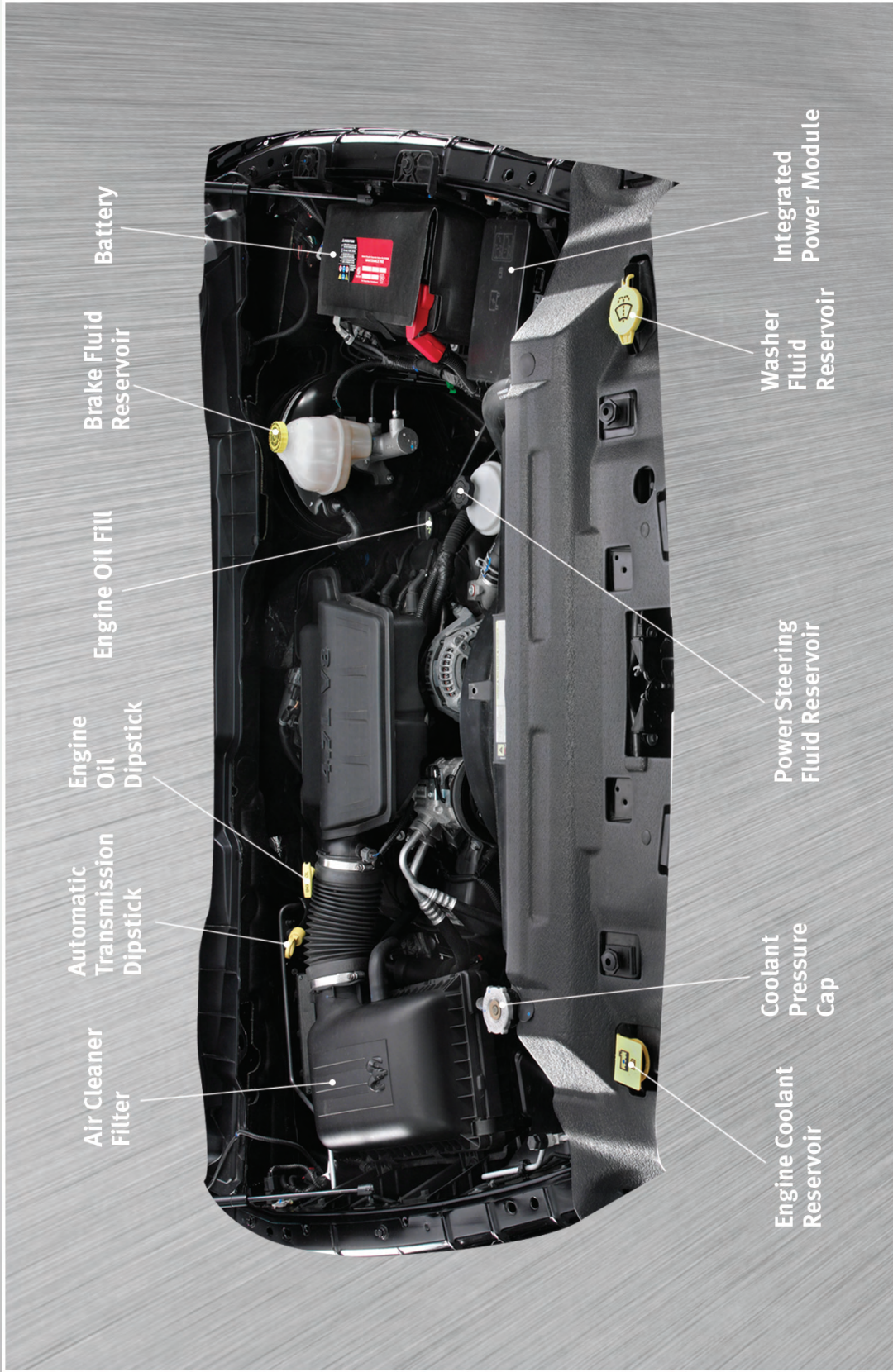

MAINTAINING YOUR VEHICLE

5.7L Engine

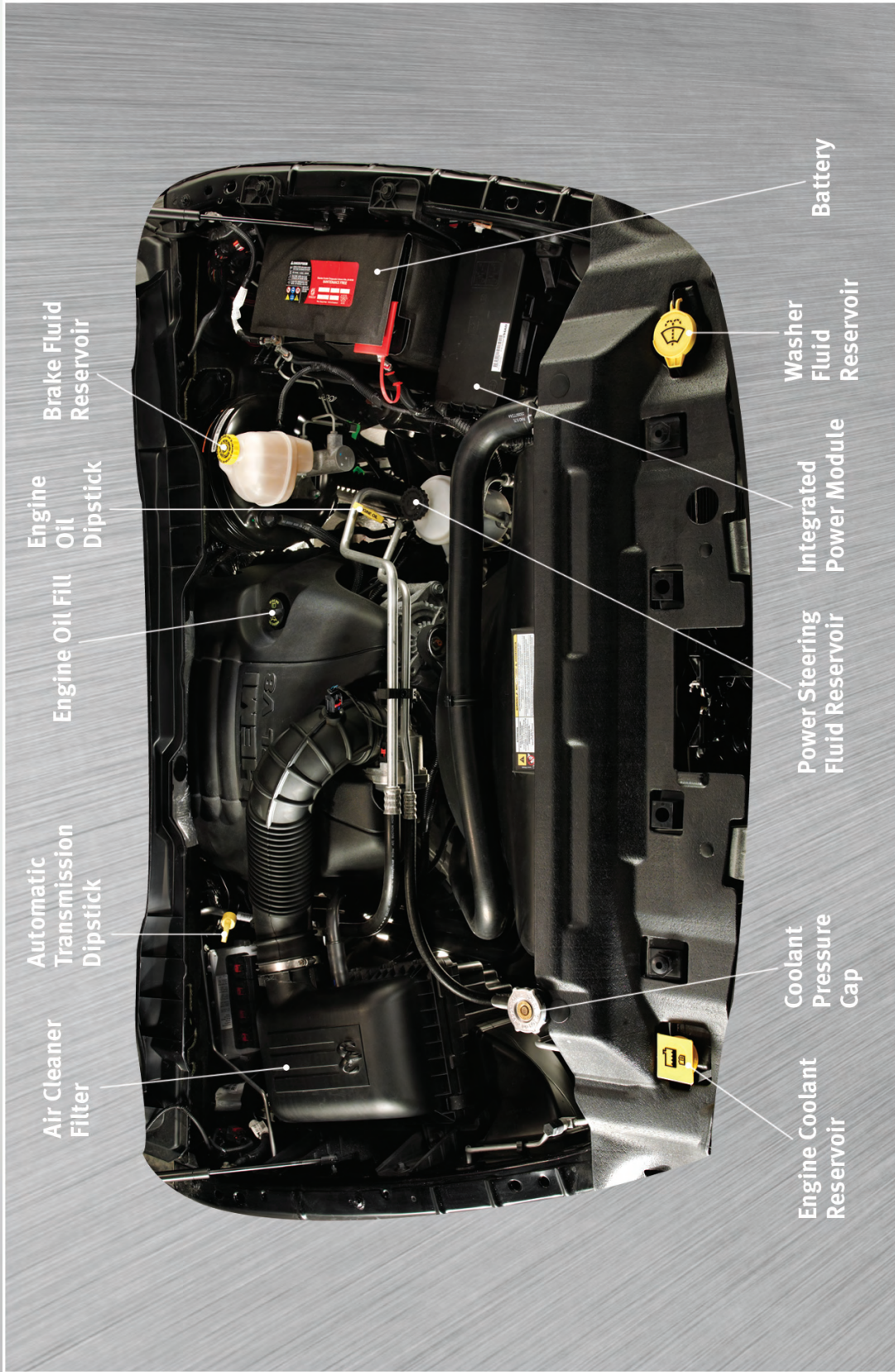

MAINTAINING YOUR VEHICLE

6.7L Diesel Engine

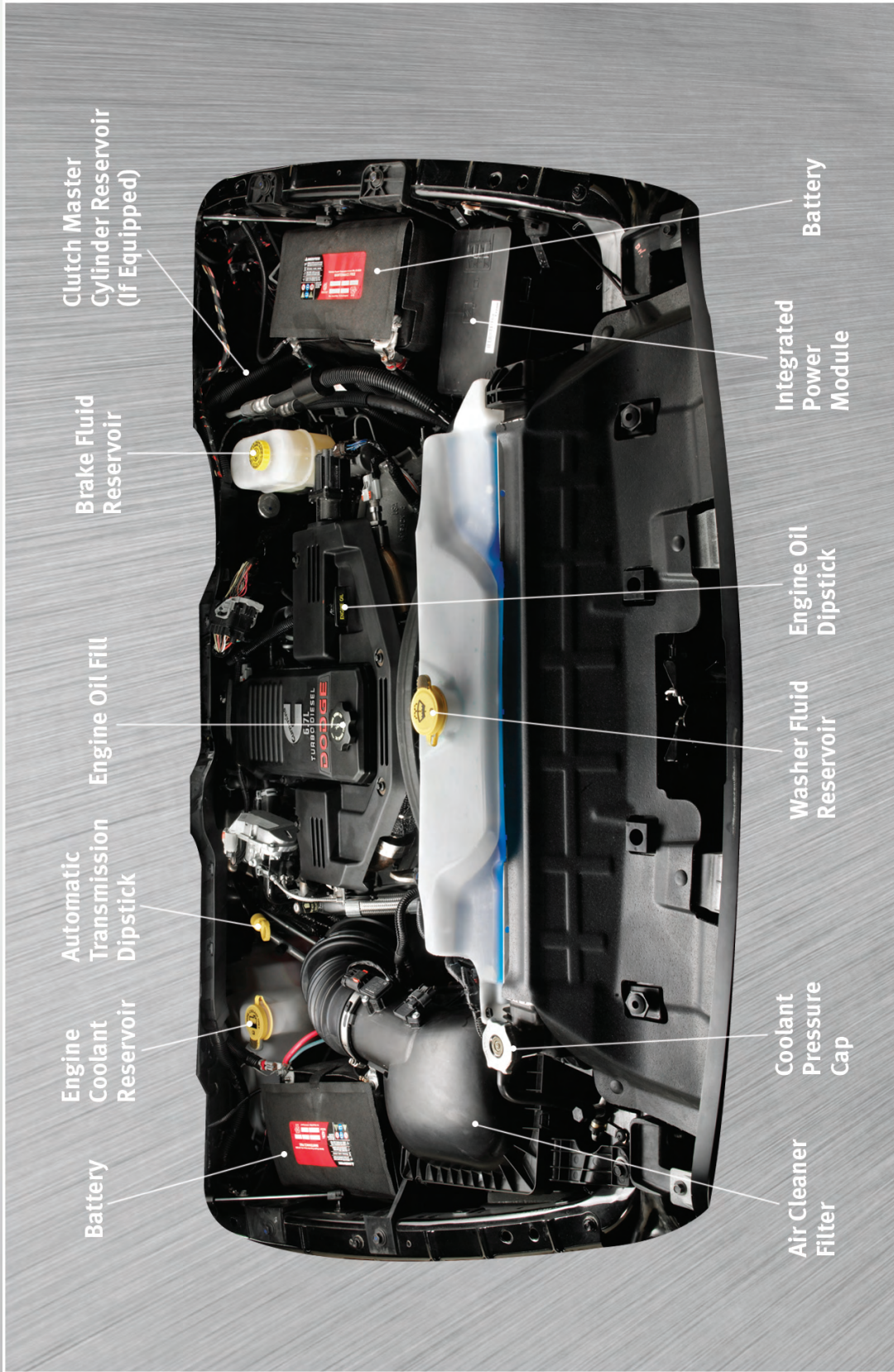

MAINTAINING YOUR VEHICLE

FUEL FILTER / WATER SEPARATOR — DIESEL ONLY

Draining Fuel / Water Separator

- If the “Water in Fuel” indicator light  is illuminated and an audible chime is heard five times, you should stop the engine and drain the water from the separator.
- The drain is located on the bottom of the Fuel Filter and Water Separator assembly which is located on the drivers side of the engine.
- Turn the drain valve (located on the side of the filter) counterclockwise 1/4 turn, then turn the ignition switch to the ON position to allow any accumulated water to drain.
- When clean fuel is visible, close the drain and switch the ignition to OFF.
- Refer to the Owner's Manual on the DVD for further details.

CAUTION!

- If the “Water In Fuel Indicator Light” remains on, DO NOT START the engine before you drain water from the fuel filter to avoid engine damage.
- Do not drain the fuel/water separator filter when the engine is running.
- Diesel fuel will damage blacktop paving surfaces. Drain the filter into an appropriate container.

Fuel Filter Replacement — Diesel Only

- With the engine off and a drain pan under the fuel filter drain hose, open the water drain valve 1/4 turn counterclockwise and completely drain fuel and water into the approved container.
- Close the water drain valve and remove the lid using a socket or strap wrench; rotate counterclockwise for removal. Remove the used o-ring and discard it.
- Remove the used filter cartridge from the housing and dispose of according to your local regulations.
- Wipe clean the sealing surfaces of the lid and housing and install the new o-ring into ring groove on the filter housing and lubricate with clean engine oil.
- Install a new filter in the housing. Push down on the cartridge to ensure it is properly seated. **Do not pre-fill the filter housing with fuel.**
- Install the lid onto the housing and tighten to 22.5 ft lbs (30.5 Nm). Do not overtighten the lid.
- Start the engine and confirm no leaks are present.

CAUTION!

- Diesel fuel will damage blacktop paving surfaces. Drain the filter into an appropriate container.
- Do not prefill the fuel filter when installing a new fuel filter. There is a possibility debris could be introduced into the fuel filter during this action. It is best to install the filter dry and allow the in-tank lift pump to prime the fuel system.

MAINTAINING YOUR VEHICLE

EXHAUST REGENERATION — DIESEL ONLY

Exhaust System — Regeneration Required Now

- Exhaust Regeneration information will be provided by the EVIC.
- “Exhaust System—Regeneration Required Now” will be displayed on the overhead console of your vehicle if the exhaust particulate filter reaches 80% of its maximum storage capacity.
- Under certain conditions, your Cummins® diesel engine and exhaust after-treatment system may never reach the conditions required to remove the trapped particulate matter. If this occurs, the “Exhaust System — Regeneration Required Now” message will be displayed and you will hear one chime to alert you of this condition. Driving your vehicle at highway speeds for as little as 45 minutes can remedy the condition and allow the engine and exhaust after-treatment system to remove the trapped particulate matter.

Exhaust Filter XX% Full

- Indicates that the Diesel Particulate Filter (DPF) is approaching full.

Exhaust System — Regeneration in Process

- Indicates that the Diesel Particulate Filter (DPF) is self-cleaning. Maintain your current driving condition until regeneration is completed.

Exhaust System — Regeneration Completed

- Indicates that the Diesel Particulate Filter (DPF) self-cleaning is completed. If this message is displayed, you will hear one chime to assist in alerting you of this condition.

Service Required — See Dealer Now

- Regeneration has been disabled due to a system malfunction. The PCM will register a fault code and the instrument panel will display the MIL light.

CAUTION!

- See your authorized dealer, as damage to the exhaust system could occur soon with continued operation.

Exhaust Filter Full — Power Reduced See Dealer

- The PCM derates the engine in order to limit the likelihood of permanent damage to the after-treatment system. If this condition is not corrected and a dealer service is not performed, extensive exhaust after-treatment damage can occur. Have your vehicle serviced by your local authorized dealer.

MAINTAINING YOUR VEHICLE

FLUIDS AND CAPACITIES

Component	Fluid, Lubricant, or Genuine Part	Capacities
Engine Coolant - 3.7L, 4.7L	MOPAR® Antifreeze/Coolant Five Year /100,000 Mile Formula HOAT (Hybrid Organic Additive Technology) or equivalent.	14 Quarts (13 Liters)
Engine Coolant - 5.7L 1500 Models	MOPAR® Antifreeze/Coolant Five Year /100,000 Mile Formula HOAT (Hybrid Organic Additive Technology) or equivalent.	16 Quarts (15 Liters)
Engine Coolant - 5.7L 2500/3500 Models	MOPAR® Antifreeze/Coolant Five Year /100,000 Mile Formula HOAT (Hybrid Organic Additive Technology) or equivalent.	18.7 Quarts (17.7 Liters)
Engine Coolant - 5.7L 2500/3500 Models w/Heavy Duty	MOPAR® Antifreeze/Coolant Five Year /100,000 Mile Formula HOAT (Hybrid Organic Additive Technology) or equivalent.	19.2 Quarts (18.2 Liters)
Engine Coolant - 6.7L Turbo Diesel Engine	MOPAR® Antifreeze/Coolant Five Year /100,000 Mile Formula HOAT (Hybrid Organic Additive Technology) or equivalent.	5.7 Gallons (21.4 Liters)
Engine Oil with Filter 3.7L, 4.7L, 5.7L	API certified 5W-20 engine oil, meeting the requirements of Chrysler Material Standard MS-6395. Refer to your oil filler cap for correct SAE grade.	3.7L Engine - 5 Quarts (4.7 Liters) 4.7L Engine - 6 Quarts (5.7 Liters) 5.7L Engine - 7 Quarts (6.6 Liters)
Engine Oil with Filter 5.7L For 2500/3500 trucks operating with a gross combined weight rating greater than 14,000 lbs/(6,350 kg.)	Use API Certified SAE 5W-30 engine oil, meeting the requirements of Chrysler Material Standard MS-6395. Refer to your engine oil filler cap for correct SAE grade.	5.7L Engine - 7 Quarts (6.6 Liters)
Engine Oil with Filter 6.7L Turbo Diesel Engine	In ambient temperatures below 0°F (-18°C), 5W-40 synthetic engine oil that meets Chrysler Materials Standard MS-10902 and the API CJ-4 engine oil category is required. In ambient temperatures above 0°F (-18°C), 15W-40 engine oil that meets Chrysler Materials Standard MS-10902 and the API CJ-4 engine oil category is required.	12 Quarts (11.4 Liters)

MAINTAINING YOUR VEHICLE

Component	Fluid, Lubricant, or Genuine Part	Capacities
Fuel Selection 3.7L, 4.7L	87 Octane	1500 Regular Cab Shortbed/Crew Quad Cab - 26 Gallons (98 Liters) 1500 Regular Cab Longbed/Crew Quad Cab (Optional) - 32 Gallons (121 Liters) 2500/3500 Shortbed - 34 Gallons (129 Liters) 2500/3500 Longbed - 35 Gallons (132 Liters)
Fuel Selection 5.7L	87 Octane Acceptable - 89 Octane Recommended	1500 Regular Cab Shortbed/Crew Quad Cab - 26 Gallons (98 Liters) 1500 Regular Cab Longbed/Crew Quad Cab (Optional) - 32 Gallons (121 Liters) 2500/3500 Shortbed - 34 Gallons (129 Liters) 2500/3500 Longbed - 35 Gallons (132 Liters)
Fuel Selection 6.7L Turbo Diesel Engine	Use good quality diesel fuel from a reputable supplier in your vehicle. Federal law requires that you must fuel this vehicle with Ultra Low Sulfur Highway Diesel fuel (15 ppm Sulfur maximum) and prohibits the use of Low Sulfur Highway Diesel fuel (500 ppm Sulfur maximum) to avoid damage to the emissions control system. For most year-round service, No. 2 diesel fuel meeting ASTM specification D-975 Grade S15 will provide good performance. If the vehicle is exposed to extreme cold (below 20°F or -7°C), or is required to operate at colder-than-normal conditions for prolonged periods, use climatized No. 2 diesel fuel or dilute the No. 2 diesel fuel with 50% No. 1 diesel fuel. This will provide better protection from fuel gelling or wax-plugging of the fuel filters. This vehicle is fully compatible with biodiesel blends up to 5% biodiesel meeting ASTM specification D-975.	2500/3500 Shortbed - 34 Gallons (129 Liters) 2500/3500 Longbed - 35 Gallons (132 Liters)

MAINTAINING YOUR VEHICLE

Component	Fluid, Lubricant, or Genuine Part	Capacities
Engine Oil Filter 3.7L, 4.7L, 5.7L, 6.7L	MOPAR [®] Engine Oil Filter or equivalent.	—
Engine Fuel Filter 6.7L Turbo Diesel Engine	MOPAR [®] Fuel Filter or equivalent. Must meet 5 micron rating. Using a fuel filter that does not meet the manufacturers filtration and water separating requirements can severely impact fuel system life and reliability.	—
Crankcase Ventilation Filter 6.7L Turbo Diesel Engine	MOPAR [®] CCV Filter or equivalent.	—
Spark Plug 3.7L	ZFR6F-11G (Gap 0.043 in [1.09 mm])	—
Spark Plug 4.7L	Upper Bank — FR8TE2 (Gap 0.039 in [0.99 mm]) Lower Bank — FR8T1332 (Gap 0.051 in [1.30 mm]).	—
Spark Plug 5.7L	LZFR5C-11 (Gap 0.043 in [1.09 mm])	—
Automatic Transmission	MOPAR [®] ATF+4 [®] Automatic Transmission Fluid or equivalent licensed ATF+4 [®] product.	—
Clutch Linkage	MOPAR [®] Multi-Purpose Grease, NLGI Grade 2 E.P. or equivalent.	—
Manual Transmission (G-56)	MOPAR [®] ATF+4 [®] Automatic Transmission Fluid or equivalent licensed ATF+4 [®] product.	—
Transfer Case	MOPAR [®] ATF+4 [®] Automatic Transmission Fluid or equivalent licensed ATF+4 [®] product.	—
Transfer Case - NVG 246 Only	MOPAR [®] NVG 246 Automatic Transmission Fluid or equivalent.	—
Front Axle - 1500 Four-Wheel Drive Models	GL-5 SAE 75W-90 (MS-9763) or equivalent.	—
Rear Axle - 1500 Models	MOPAR [®] Synthetic Gear Lubricant SAE 75W-140 (MS-8985). Limited-Slip Rear Axles require the addition of 118 ml (4 oz.) MOPAR [®] Limited Slip Additive or equivalent.	—
Front and Rear Axle - 2500/3500 Models	Synthetic, GL-5 SAE, 75W-90 or equivalent. Limited-Slip 10.5/11.5 inch Rear Axles Limited slip additive is not required.	—

MAINTAINING YOUR VEHICLE

Component	Fluid, Lubricant, or Genuine Part	Capacities
Brake Master Cylinder	MOPAR [®] DOT 3 and SAE J1703 should be used or equivalent. If DOT 3 is not available, then DOT 4 is acceptable. Use only recommended Brake Fluids.	—
Power Steering Reservoir	MOPAR [®] Power Steering Fluid +4 or MOPAR [®] ATF+4 [®] Automatic Transmission Fluid or equivalent licensed ATF+4 [®] product.	—

MAINTAINING YOUR VEHICLE

MAINTENANCE CHART GAS ENGINE

	Miles:		6,000	12,000	18,000	24,000	30,000	36,000	42,000	48,000	54,000	60,000	66,000	72,000	78,000
	Or Months:	Or Kilometers:													
Change the engine oil and filter.	6	10,000	X	X	X	X	X	X	X	X	X	X	X	X	X
Rotate the tires.	X	X	X	X	X	X	X	X	X	X	X	X	X	X	X
If using your vehicle for any of the following: Dusty or off-road conditions. Inspect the engine air cleaner filter, replace if necessary.	X	X			X			X		X				X	
Lube the front drive shaft fittings (2500/3500 4x4 models only).	X	X		X	X	X	X	X	X	X	X	X	X	X	X
Inspect the brake linings, replace if necessary.		X		X	X	X	X	X	X	X	X	X	X	X	X
Inspect the CV joints.		X		X	X	X	X	X	X	X	X	X	X	X	X
Inspect the exhaust system.		X		X	X	X	X	X	X	X	X	X	X	X	X
Replace the engine air cleaner filter.						X						X			
Inspect the front and rear axle fluid, change if using your vehicle for police, taxi, fleet, off-road or frequent trailer towing.					X			X			X			X	
Inspect the transfer case fluid.							X								
Change the transfer case fluid if using your vehicle for any of the following: police, taxi, fleet, or frequent trailer towing.												X			
Change the automatic transmission fluid and filter if using your vehicle for any of the following: police, taxi, fleet of frequent trailer towing.												X			
Inspect the front suspension, tie rod ends and boot seals for cracks or leaks and all parts for damage, wear, improper looseness or end play; replace if necessary.		X		X	X	X	X	X	X	X	X	X	X	X	X
Replace the spark plugs (3.7L and 5.7L Engines).							X								
Replace top row of spark plugs (4.7L engine)										X					

- Refer to the Owner's Manual on the DVD for the complete maintenance schedule.

MAINTAINING YOUR VEHICLE

Maintenance Record

	Odometer	Date	Signature, Authorized Service Center
6,000 Miles (10,000 km) or 6 Months			
12,000 Miles (20,000 km) or 12 Months			
18,000 Miles (30,000 km) or 18 Months			
24,000 Miles (40,000 km) or 24 Months			
30,000 Miles (50,000 km) or 30 Months			
36,000 Miles (60,000 km) or 36 Months			
42,000 Miles (70,000 km) or 42 Months			
48,000 Miles (80,000 km) or 48 Months			
54,000 Miles (90,000 km) or 54 Months			
60,000 Miles (100,000 km) or 60 Months			
66,000 Miles (110,000 km) or 66 Months			
72,000 Miles (120,000 km) or 72 Months			
78,000 Miles (130,000 km) or 78 Months			

MAINTAINING YOUR VEHICLE

Diesel Engine

	Miles:		Or Months:		Or Kilometers:		7,500	15,000	22,500	30,000	37,500	45,000	52,500	60,000	67,500	75,000	82,500	90,000	97,500
	6	12	18	24	30,000	37,500	45,000	52,500	60,000	67,500	75,000	82,500	90,000	97,500					
When prompted by the Engine Oil Indicator System, the engine oil and filter must be changed. If not prompted by the Engine Oil Indicator System within 7,500 miles (12 000 km) or six months since the last oil and filter change, change the engine oil and engine oil filter. Under no circumstances should oil change intervals exceed 7,500 miles (12 000 km) or six months, whichever comes first.	X	X	X	X	X	X	X	X	X	X	X	X	X	X	X	X	X	X	X
Rotate the tires.	X	X	X	X	X	X	X	X	X	X	X	X	X	X	X	X	X	X	X
Lubricate front drive shaft fitting (4x4).	X	X	X	X	X	X	X	X	X	X	X	X	X	X	X	X	X	X	X
Lubricate outer tie rod ends.	X	X	X	X	X	X	X	X	X	X	X	X	X	X	X	X	X	X	X
Replace fuel filter element.		X		X	X	X	X	X	X	X	X	X	X	X	X	X	X	X	X
Inspect the brake linings.			X																
Inspect and adjust parking brake.			X																
Inspect the front (4x4) and rear axle fluid, change if using your vehicle for police, taxi, fleet, off-road or frequent trailer towing		X		X	X	X	X	X	X	X	X	X	X	X	X	X	X	X	X
Inspect drive belt; replace as required.			X																
Check the transfer case fluid (4x4).				X															
Change the transfer case fluid (4x4).																			
Inspect the manual transmission fluid, add if necessary.																			
Inspect the front suspension, tie rod ends and boot seals for cracks or leaks and all parts for damage, wear, improper looseness or end play; replace if necessary..		X		X	X	X	X	X	X	X	X	X	X	X	X	X	X	X	X
Inspect wheel bearings.				X	X	X	X	X	X	X	X	X	X	X	X	X	X	X	X
Change automatic transmission fluid (chassis cab).				X	X	X	X	X	X	X	X	X	X	X	X	X	X	X	X

• Refer to the Owner's Manual on the DVD for the complete maintenance schedule.

MAINTAINING YOUR VEHICLE

Maintenance Record

	Odometer	Date	Signature, Authorized Service Center
7,500 Miles (12,000 km) or 6 Months			
15,000 Miles (24,000 km) or 12 Months			
22,500 Miles (36,000 km) or 18 Months			
30,000 Miles (40,000 km) or 24 Months			
37,500 Miles (60,000 km) or 30 Months			
45,000 Miles (72,000 km) or 36 Months			
52,500 Miles (84,000 km) or 42 Months			
60,000 Miles (96,000 km) or 48 Months			
67,500 Miles (108,000 km) or 54 Months			
75,000 Miles (120,000 km) or 60 Months			
82,500 Miles (132,000 km) or 66 Months			
90,000 Miles (144,000 km) or 72 Months			
97,500 Miles (156,000 km) or 78 Months			

MAINTAINING YOUR VEHICLE

FUSES

Totally Integrated Power Module (TIPM) Gas Engine

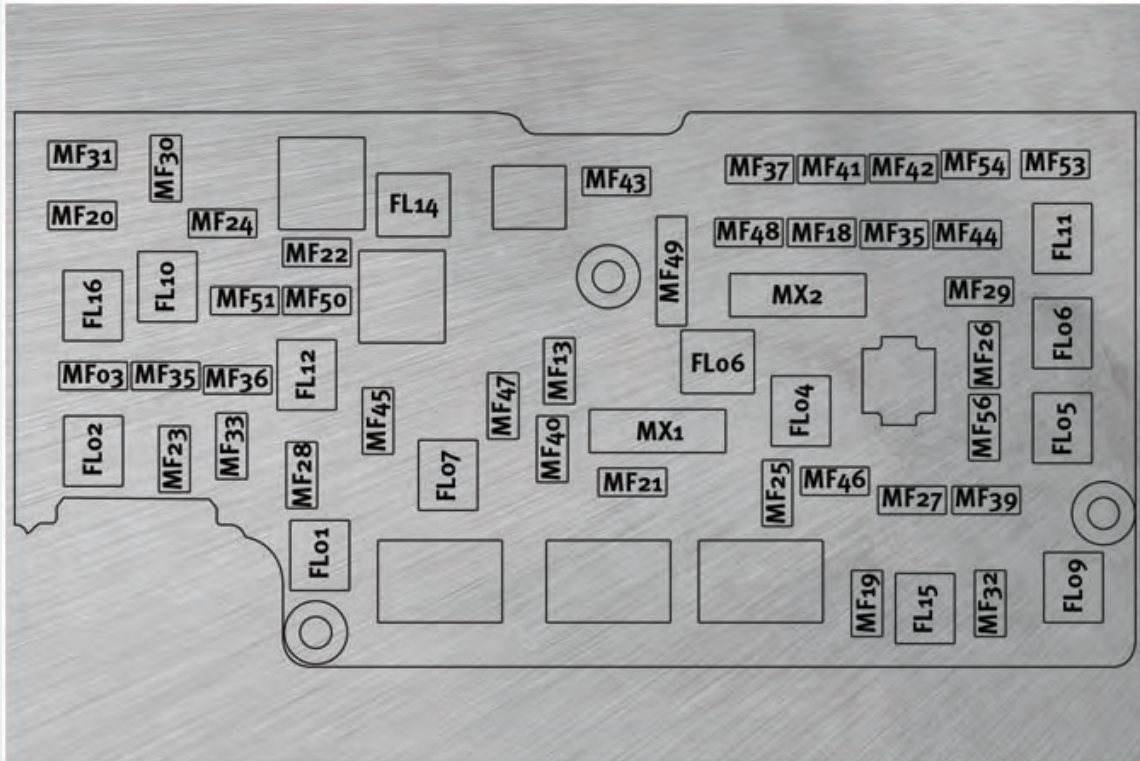

- The Totally Integrated Power Module (TIPM) is located in the engine compartment near the battery. This center contains cartridge fuses and mini fuses.

Cavity	Cartridge Fuse	Mini Fuse	Description
FL01	30 Amp Pink		Bat – Presafe #1
FL02	30 Amp Pink		Bat – Trailer Tow Main
FL03	25 Amp Natural		Bat – Passenger Door Node
FL04	40 Amp Green		Bat – ABS Pump
FL05	30 Amp Pink		Bat – ABS Valve
FL06	30 Amp Pink		Bat – H/Lamp Wash/MTV/CM2200/ Elec Vac Pump
FL07	25 Amp Natural		Bat – Driver Door Node
FL08	30 Amp Pink		Bat – DTCM/Axle Locks
FL09	30 Amp Pink		Bat – Plg/Electric Brake
FL10	40 Amp Green		Bat – L/Bar/Off-Road
FL11	30 Amp Pink		Bat – Sway/Thatchum/Rear Doors
FL12	40 Amp Green		Starter Solenoid
FL13	60 Amp Yellow		Bat – Rad Fan #1/#2/SSR
FL14	40 Amp Green		Bat – Folding Seat/PZEV
FL15	60 Amp Yellow		Bat – IOD Main
FL16	40 Amp Green		Frt HVAC Motor

MAINTAINING YOUR VEHICLE

Cavity	Cartridge Fuse	Mini Fuse	Description
MF17		25 Amp Natural	Bat – Sunroof/Skylight
MF18		25 Amp Natural	TCM/Trans Range
MF19		5 Amp Tan	Ign R/ACC – Sunroof/Window Sw Illum
MF20		25 Amp Natural	Frnt Wiper
MF21		25 Amp Natural	Door Locks
MF22		20 Amp Yellow	Fuel Pump
MF23		20 Amp Yellow	Bat – Trlr Light/Pre-Safe #2
MF24		20 Amp Yellow	Bat – Trlr Tow BUX/HGM
MF25		10 Amp Red	Bat – J1962 Diag/Mirrors
MF26		10 Amp Red	Bat – Ign Sw, WIN, PASS
MF27		15 Amp Blue	Bat – CHMSL/Brake Sw
MF28		10 Amp Red	Bat – Corax TPM/PEM/HVAC Htr Pump
MF29		15 Amp Blue	Bat – Folding Mirror
MF30		25 Amp Natural	Bat – Inverter
MF31		20 Amp Yellow	Bat – Pwr Out #1
MF32		20 Amp Yellow	Fr/Rr Washer
MF33		15 Amp Blue	Bat – NGC/EATX/PCM
MF34		15 Amp Blue	Bat – CCN/Interior Light/SCM/Sw Bank
MF35		20 Amp Yellow	Ign R-Frt Seat/Vent
MF36		20 Amp Yellow	Ign R-Rear Seat/Steer Wheel
MF37		10 Amp Red	Horn #1
MF38		20 Amp Yellow	IOD-CCN/Interior Mods
MF39		30 Amp Green	IOD-Amp/Radio
MF40		25 Amp Natural	Rear Wiper
MF41		15 Amp Blue	IOD-SDARS/VEST™ 2-3/DVD/HFM/UGDO/Vanity Lamp
MF42		10 Amp Red	IOD-HVAC, U/Hood Lamp
MF43		10 Amp Red	Horn #2
MF44		10 Amp Red	IGN R/S-ORC/OCM
MF45		10 Amp Red	IGN R-ORC/Trail Tow (BUX) Sense
MF46		20 Amp Yellow	IGN R-Trail Tow (BUX)
MF47		10 Amp Red	IGN R-H/Lamp Wash/HVAC/Park Assist/Ir Sns
MF48		20 Amp Yellow	IGN R/ACC-Pwr Outlet #2
MF49		20 Amp Yellow	IGN R/ACC/Bat-Pwr Outlet #3
MF50		25 Amp Natural	ASD #1, #2
MF51		20 Amp Yellow	ASD #3
MF52		10 Amp Red	IGN R/S-SWAY/TCASE/DTCM/FAD
MF53		15 Amp Blue	IGN R/S-MFSW/CNN/SCM/TPM/RR View
MF54		20 Amp Yellow	IOD – Spare

MAINTAINING YOUR VEHICLE

Totally Integrated Power Module (TIPM)-Diesel Only

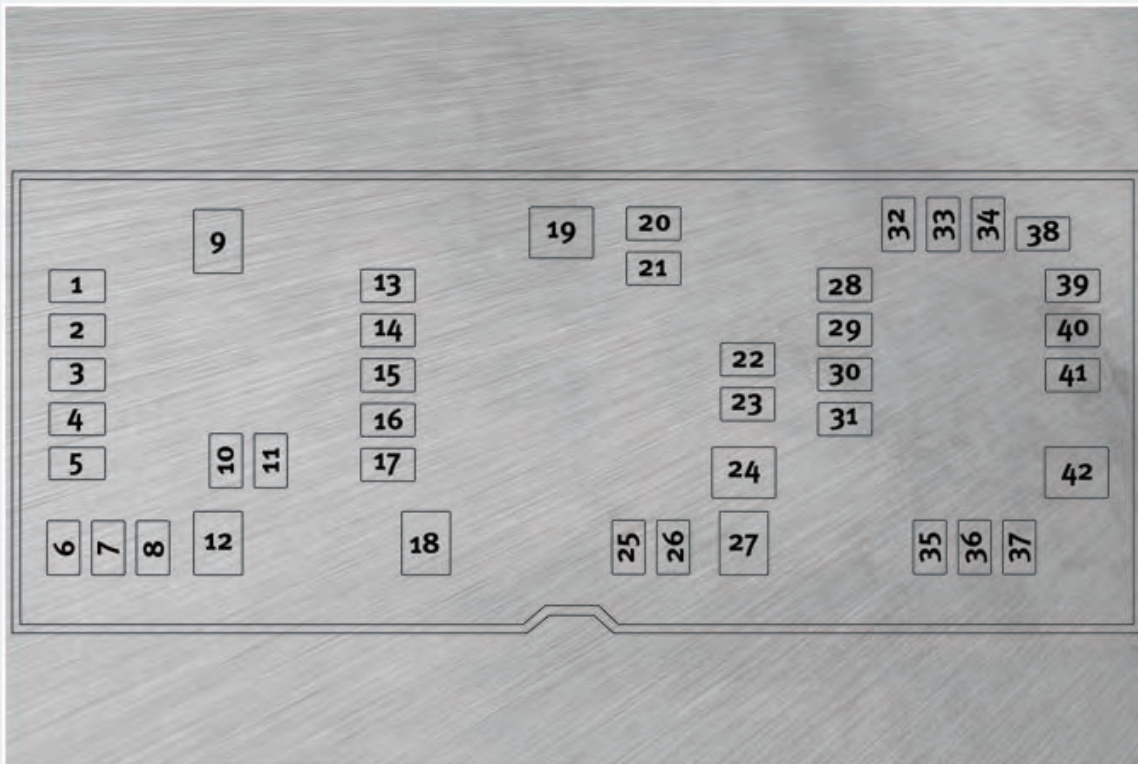

- The Totally Integrated Power Module (TIPM) is located in the engine compartment near the battery. This center contains cartridge fuses and mini fuses..

Cavity	Cartridge Fuse	Mini Fuse	Description
1		20 Amp Yellow	Power Outlet Console
2		20 Amp Yellow	Cabin Compartment Node (CCN) Door Locks
3	—	—	—
4		15 Amp Blue	Aisin Transmission Controls (Diesel Only)
5		20 Amp Yellow	Power Sunroof
6		10 Amp Red	Vistrionic Fan/Wastegate Solenoid
7	—	—	—
8		10 Amp Red	Heated Mirrors
9	30 Amp Pink		Off Road Module Power
10		5 Amp Orange	Trx-Off Rd Pkg Sen (Gas Engine Only) NOTE: Insert 5 amp fuse in this cavity to enable the TRX capability (If Equipped).
11	20 Amp Yellow	20 Amp Yellow	Ignition Off Draw (IOD)-Cabin Compartment Node (CCN)/Radio/Under Hood Lamp/Wireless Control Module (WCM)/Satellite Digital Audio Receiver (SDARS)/Hands Free Module (HFM)/EOM

MAINTAINING YOUR VEHICLE

Cavity	Cartridge Fuse	Mini Fuse	Description
12	30 Amp Pink		Electric Brake
13		25 Amp Natural	Power-Battery RWAL/ABS Module Feed
14		15 Amp Blue	Park Lights Left
15		20 Amp Yellow	Trailer Park Lights
16		15 Amp Blue	Park Lights Right
17	—	—	—
18	40 Amp Green		ABS Pump
19	30 Amp Pink		Trailer Tow Battery Feed
20		10 Amp Red	Occupant Restraints Controller (ORC) 2
21		10 Amp Red	Occupant Restraints/Pass Disable Switch
22		2 Amp Gray	IGN Switch Feed
23		10 Amp Red	HVAC
24	20 Amp Blue		AISIN Relay Feed (Diesel Only)
25		10 Amp Red	Power Mirror/T-Case Brake
26		20 Amp Yellow	Brake Switch/Center High Mount Stop Light (CHMSL)/Aftermarket CHMSL
27	40 Amp Green		Power Seats
28		10 Amp Red	Power Run/Start-PCM/Steering Angle Sensor
29		10 Amp Red	4X4 Switch/Pass Dr Switch/EC Mirror
30		15 Amp Blue	Power Run/Start-ABS/RWAL/Smart Bar/YAW Sensor/Universal Exhaust Gas Oxygen (Uego) Sensor Controller
31		10 Amp Red	PCM (Gas)/TCM (Diesel 58RFE)
32		10 Amp Red	Power Ignition Run — Adjustable Pedals LED
33		10 Amp Red	Power-IGN Run — HVAC
34	—	—	—
35		15 Amp Blue	Cabin Compartment Node (CCN) Illumination
36		25 Amp Natural	Audio_Amplifier
37		15 Amp Blue	Variable Gate Turbo (VGT) — Turbo Diesel
38		20 Amp Yellow	Power Outlet IP
39		10 Amp Red	Seatbelt Tension Reducer/Power IGN Run/Acc
40		20 Amp Yellow	Power IGN Run/Acc — Cigar Lighter/Rear Power Point
41	—	—	—
42	30 Amp Pink		Diesel PCM (Diesel Only)

MAINTAINING YOUR VEHICLE

TIRE PRESSURES

- Check the inflation pressure of each tire, including the spare tire, at least monthly and inflate to the recommended pressure for your vehicle.
- The tire pressures recommended for your vehicle are found on the “Tire and Loading Information” label located on the driver’s side door opening.

NOTE: Refer to the Owner's Manual on the DVD for more information on the life of tires.

WARNING!

Overloading of your tires is dangerous. Overloading can cause tire failure, affect vehicle handling, and increase your stopping distance. Use tires of the recommended load capacity for your vehicle. Never overload them.

WARNING!

Improperly inflated tires are dangerous and can cause accidents. Under-inflation is the leading cause of tire failure and may result in severe cracking, component separation, or “blow out”. Over-inflation reduces a tire’s ability to cushion shock. Objects on the road and chuck holes can cause damage that results in tire failure. Unequal tire pressures can cause steering problems. You could lose control of your vehicle. Over-inflated or under-inflated tires can affect vehicle handling and can fail suddenly, resulting in loss of vehicle control.

WHEEL AND WHEEL TRIM CARE

- All wheels and wheel trim, especially aluminum and chrome plated wheels should be cleaned regularly with a mild soap and water to prevent corrosion.
- To remove heavy soil and/or excessive brake dust, use MOPAR® Wheel Cleaner or equivalent or select a nonabrasive, non-acidic cleaner.

CAUTION!

Do not use scouring pads, steel wool, a bristle brush, or metal polishes. Do not use oven cleaner. These products may damage the wheels protective finish. Avoid automatic car washes that use acidic solutions or harsh brushes that may damage the wheels protective finish. Only MOPAR® Wheel Cleaner or equivalent is recommended.

MAINTAINING YOUR VEHICLE

EXTERIOR BULBS

LIGHT BULBS – Exterior	Bulb Number
Backup	921
Center High-Mounted Stop Lamp (CHMSL)	921
Fog Lamp - If Equipped	9145
Front Park/Turn Signal	3757A
Front Side Marker	3757A
Front Position Lamp	W5W
Dual Headlamp	H13
Quad Headlamp Low Beam	H11
Quad Headlamp High Beam	9005
Side Marker (Dual Headlamp)	3157K
Side Marker (Quad Headlamp)	3157NA
Rear Cargo Lamp	921
Rear Tail/Turn and Stop	3157K
Cab Roof Marker Lamps	194NA
Side Marker Lamps (Dual Rear Wheels)	194
Rear Lamp Bar ID Marker Lamp	194
License Lamp	194

CONSUMER ASSISTANCE

CHRYSLER GROUP LLC CUSTOMER CENTER

P.O. Box 21-8004
Auburn Hills, MI 48321-8004
Phone: 1-800-992-1997

CHRYSLER CANADA INC. CUSTOMER CENTER

P.O. Box 1621
Windsor, Ontario N9A 4H6
Phone: 1-800-465-2001

ASSISTANCE FOR THE HEARING IMPAIRED

- To assist customers who have hearing difficulties, the manufacturer has installed special TDD (Telecommunication Devices for the Deaf) equipment at its customer center. Any hearing or speech impaired customer, who has access to a TDD or a conventional teletypewriter (TTY) in the United States, can communicate with the manufacturer by dialing 1-800-380-CHRY. Canadian residents with hearing difficulties that require assistance can use the special needs relay service offered by Bell Canada. For TTY teletypewriter users, dial 711 and for Voice callers, dial 1-800-855-0511 to connect with a Bell Relay Service operator.

WARNING!

Engine exhaust, some of its constituents, and certain vehicle components contain, or emit, chemicals known to the State of California to cause cancer and birth defects, or other reproductive harm. In addition, certain fluids contained in vehicles and certain products of component wear contain, or emit, chemicals known to the State of California to cause cancer and birth defects, or other reproductive harm.

PUBLICATIONS ORDERING

- If you are the first registered retail owner of your vehicle, you may obtain a free printed copy of the Owner's Manual, Warranty Booklet or Radio Manuals on your DVD by calling 1-800-992-1997 (U.S.) or 1-800-387-1143 (Canada) or by contacting your dealer.
- Replacement User Guides or DVDs or, if you prefer, a printed copy of the Owner's Manual, Warranty Booklet or Radio Manuals may be purchased by visiting www.techauthority.com or by calling 1-800-890-4038 (U.S.) or 1-800-387-1143 (Canada). Visa, Master Card, American Express and Discover orders are accepted. If you prefer mailing your order, please call the above numbers for an order form.

NOTE: A street address is required when ordering manuals (no P.O. Boxes).

CONSUMER ASSISTANCE

REPORTING SAFETY DEFECTS IN THE 50 UNITED STATES AND WASHINGTON, D.C.

- If you believe that your vehicle has a defect that could cause a crash or cause injury or death, you should immediately inform the National Highway Traffic Safety Administration (NHTSA) in addition to notifying the manufacturer.
- If NHTSA receives similar complaints, it may open an investigation, and if it finds that a safety defect exists in a group of vehicles, it may order a recall and remedy campaign. However, NHTSA cannot become involved in individual problems between you, your authorized dealer, and the manufacturer.
- To contact NHTSA, you may either call the Auto Safety Hotline toll free at 1-888-327-4236 (TTY: 1-800-424-9153), or go to <http://www.safercar.gov>; or write to: Administrator, NHTSA, 1200 New Jersey Avenue, SE., West Building, Washington, D.C. 20590. You can also obtain other information about motor vehicle safety from <http://www.safercar.gov>.

In Canada

- If you believe that your vehicle has a safety defect, you should contact the Customer Service Department immediately. Canadian customers who wish to report a safety defect to the Canadian government should write to: Transport Canada, Motor Vehicle Defect Investigations and Recalls, 2780 Sheffield Road, Ottawa, Ontario K1B 3V9.

TIRE WARRANTY

Tire Limited Warranty And Adjustment Policy

- When a tire is removed from service due to a covered warranty condition under a tire manufacturer's "Limited Warranty Program", you may be eligible for a free tire replacement or a comparable new tire on a "prorated basis".
- Certain conditions, such as irregular wear or tire damage due to road hazards, collision, improper inflation, intentional alteration, and misuse, are excluded from the Limited Warranty Program. The Limited Warranty Program expires when your tires either wear to a specified tread depth, and/or after a period of time from the date of purchase, as stated in the Tire Warranty on the DVD.

NOTE: Refer to the Tire Warranty on the DVD for specific information relating to the manufacturer's limited warranty for the tires installed on your vehicle. The DVD can play on any computer or DVD player. If you have any questions regarding the limited tire warranty coverage, contact your local Chrysler dealer or your local authorized tire dealer. If you cannot access the DVD and would like a paper copy of the limited warranty for the tires installed on your vehicle, call 1-800-922-1997 (U.S.) or 1-800-387-1143 (Canada) or ask your Chrysler dealer.

CONSUMER ASSISTANCE

Disclaimer:

- THE TIRE MANUFACTURER'S LIMITED WARRANTY PROGRAM, THE DETAILS OF WHICH CAN BE FOUND, ON THE OWNERS MANUAL DVD, THE TIRE MANUFACTURER'S WEBSITE OR AT ANY AUTHORIZED SERVICE CENTER ARE IN LIEU OF ALL OTHER REMEDIES OR WARRANTIES, EXPRESS OR IMPLIED, ARISING BY LAW OR OTHERWISE, INCLUDING FITNESS FOR A PARTICULAR PURPOSE OR MERCHANTABILITY. THE TIRE MANUFACTURER EXPRESSLY DISCLAIMS LIABILITY FOR INDIRECT, SPECIAL, INCIDENTAL OR CONSEQUENTIAL DAMAGES, LOST PROFIT, LOSS OF BUSINESS, LOSS OF GOODWILL, LOSS OF REPUTATION, PUNITIVE OR ANY OTHER DAMAGE, COST OR LOSS OF ANY KIND. SOME STATES AND PROVINCES DO NOT ALLOW THE EXCLUSION OR LIMITATION OF INCIDENTAL OR CONSEQUENTIAL DAMAGES, SO THE ABOVE LIMITATION OR EXCLUSION MAY NOT APPLY TO YOU.

WARNING!

NOTE: Refer to the Owner's Manual on the DVD for complete warning information that could prevent accidents, injuries and even deaths.

WARNING!

Death, serious injury and/or property damage may result from:

- Tire failure due to impact damage and/or improper maintenance.
- Tires should be inspected regularly by a qualified technician for signs of damage, such as punctures, impacts, underinflation or overloading.
- Progressive air loss may result from punctures, cuts, curbing, impacts or partial bead unseating. Some fitment causes for air loss are:
 - Incomplete bead seating.
 - Bead tearing caused by a machine tool due to insufficient lubrication or improper adjustment.
 - Leaking valve core or rubber valve components (these should be replaced when problems are detected and whenever tires are replaced).
- Tire failure due to improper repairs.
- See Rubber Manufacturer's Association (RMA) established repair procedures at www.rma.org for information on proper repair procedures. Never perform a temporary repair or use an inner tube as a substitute for a proper repair. Only qualified persons should repair tires.
- Explosion of tire/rim assembly due to improper mounting.
- Only specially trained persons should mount tires.
- Failure to mount tires on approved rims.
- Failure to deflate single or dual assemblies completely before demounting.

CONSUMER ASSISTANCE

Using Lift Kits

- Use of lift kits with some vehicle/tire combinations can cause instability or loss of control. When changing tire sizes, always consult an installer for optimum rim width and carefully check vehicle/tire clearances.

Check Your Tires For Damage

- Frequent (at least monthly) inspection of your tires for signs of damage, uneven tread wear and their general condition is important for safety. Impacts, penetrations, cracks, knots, bulges or air loss always require tire removal and expert inspection.

Tire Service Life

- The service life of a tire is dependent upon varying factors including, but not limited to, your driving style, tire pressure and distance driven.

WARNING!

Tires and the spare tire should be replaced after six years, regardless of the remaining tread. Failure to follow this warning can result in sudden tire failure. You could lose control and have an accident resulting in serious injury or death.

- Keep dismantled tires in a cool, dry place with as little exposure to the light as possible.
- Protect tires from contact with oil, grease, and gasoline.

NOTE: All tire warranties are made by the tire manufacturer. Tires are not covered under your Chrysler New Vehicle Limited Warranty.

MOPAR ACCESSORIES

MOPAR[®] ACCESSORIES

- The following highlights just some of the authentic Dodge Truck Accessories by MOPAR[®] that have been engineered to customize your Dodge Ram.
- To see the full line of accessories stop by your Dodge dealer or visit MOPAR.com.

CHROME:

- Exhaust Tip
- Chrome Cast Aluminum Wheels
- Tubular Side Steps
- Front Air Deflector
- Fuel Filler Door
- Grille

EXTERIOR:

- Under The Rail Bedliner
- Fiberglass Tonneau Cover
- Snapless Tonneau Cover
- Molded Splash Guards
- Side Window Air Deflectors
- Bed Extender
- Bed Step
- Hitch Receiver
- Fender Flares
- Bed Mat
- Tuner Style Tail lamps
- Performance-Inspired Hood

INTERIOR:

- Premium Carpet Floor Mats
- Ambient Light Kit
- Door Sill Guards
- Bright Pedal Kit
- Slush Mats
- Heated Seats

ELECTRONICS:

- Portable Navigation Systems
- iPod[®] Adapter
- Kicker[®] Sound Systems
- uconnect[™] web (WiFi)
- uconnect[™] gps (RER Radio)
- Head Restraint DVD Rear Seat Video
- Sirius Satellite Radio
- uconnect[™] tunes (REN Radio)
- DVD Rear Seat Video[™]

CARRIERS:

- Bed Mounted Bike Carrier
- Bed Mounted Ski and Snowboard Carrier
- Bed Mounted Cargo Basket With Cargo Net
- Cargo Bed Divider
- Cargo Ramps
- Diamond Plate Toolbox

- iPod[®] is a registered trademark of Apple Inc.
- Kicker[®] is a registered trademark of Stillwater Designs and Audio, Inc.





DODGE.com

This guide has been prepared to help you get quickly acquainted with your new Dodge and to provide a convenient reference source for common questions. However, it is not a substitute for your Owner's Manual.

For complete operational instructions, maintenance procedures and important safety messages, please consult your Owner's Manual, Navigation Radio User Manual, Multimedia User Manual and other Warning Labels in your vehicle.

Not all features shown in this guide may apply to your vehicle. For additional information on accessories to help personalize your vehicle, visit www.mopar.com or your local Dodge dealer.

RAM TRUCK



10D241-926-AA
Ram Truck
First Printing
User Guide